



CITY

60306



1





- 1 Scan the code on the front cover
Scanne den Code auf der Titelseite
Scanne le code sur la page de couverture
Scanner le code sur la page couverture
Scansiona il codice sulla copertina
Escanea el código de la portada
Faz scan do código na frente da capa
Olvasd be a borítón látható kódot!
Noskenē kodu uz priekšējā vāka
扫描封面上的二维码

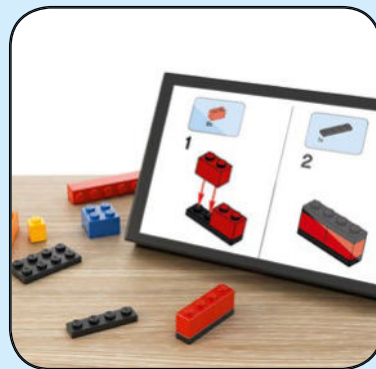

- 2 Get the Building Instructions
Hol dir die Bauanleitung
Obtiens les instructions de montage
Obtenir les instructions de montage
Scarica le istruzioni per la costruzione
Consulta las instrucciones de construcción
Obtém as Instruções de Construção
Szerezd be az építési útmutatókat!
Saņem būvēšanas instrukcijas
获取拼搭说明

LEGO.com/apps

Check for compatibility
Kompatibilität prüfen
Vérifier la compatibilité
Controlla la compatibilità
Comprueba tu compatibilidad

Verificar a compatibilidade
Ellenőrizd a kompatibilitást
Pārbaudīt saderību
检查兼容性

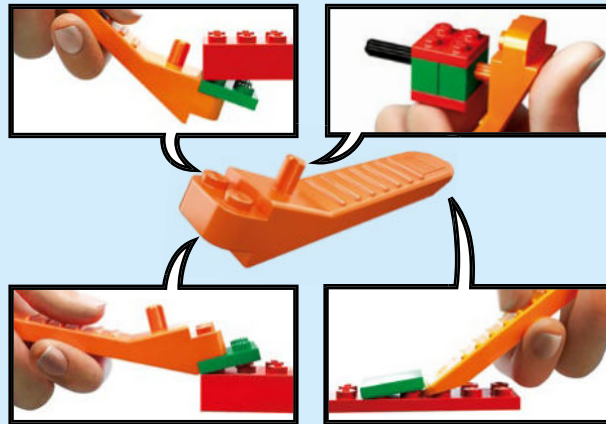

LEGO.com/brickseparator



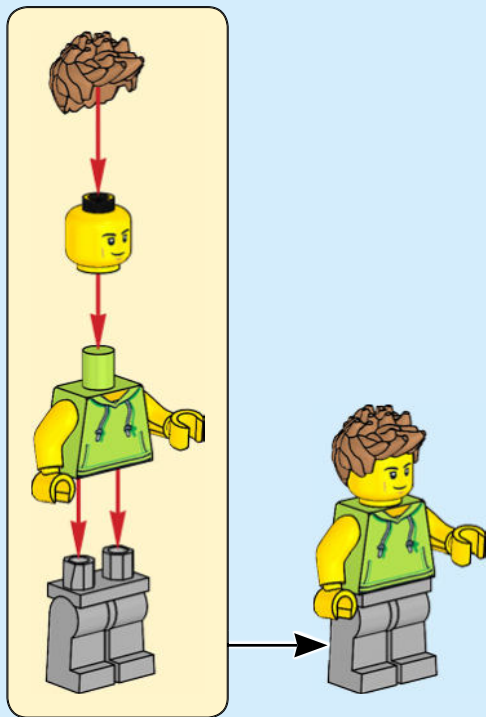

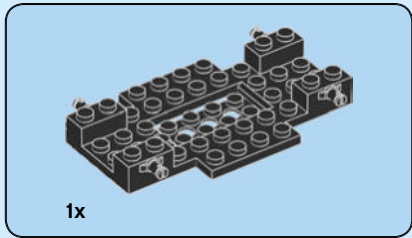

1

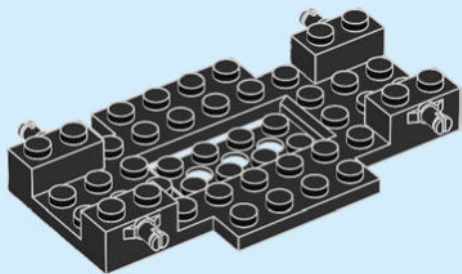

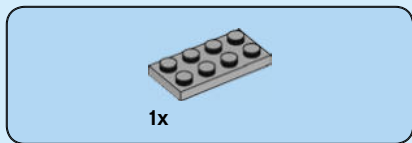

2

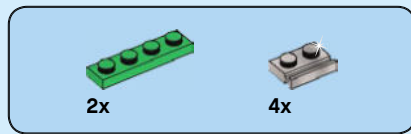
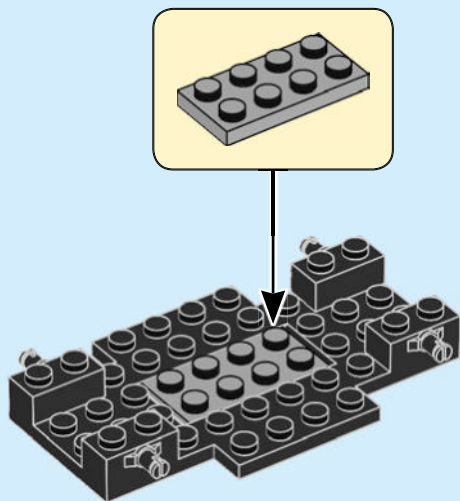

3

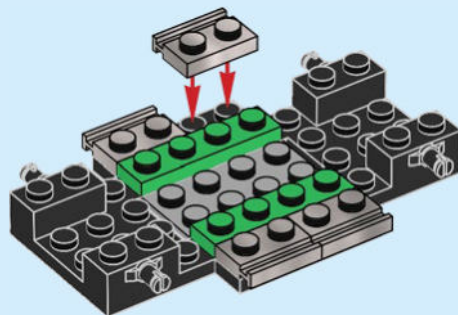

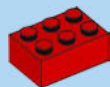

2x

4

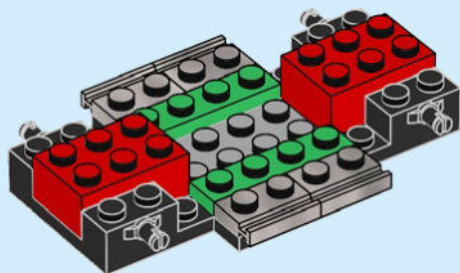

8



1x

5

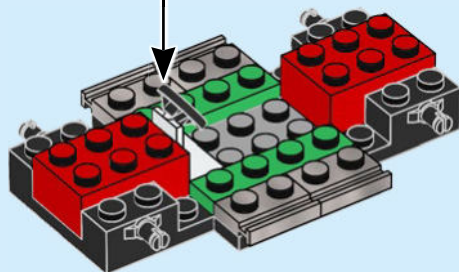

1x

6

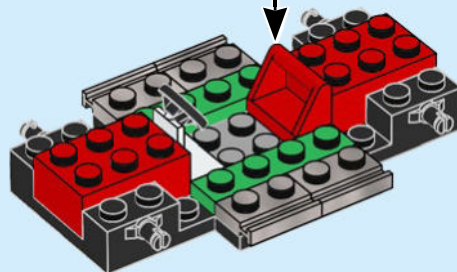
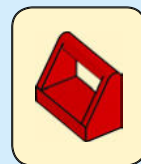



2x

7

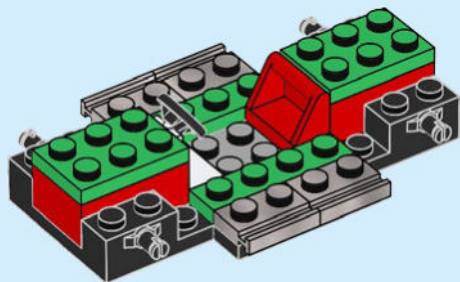

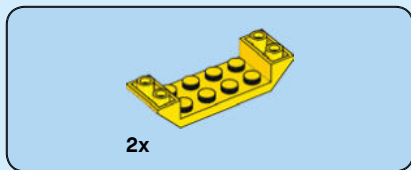

8

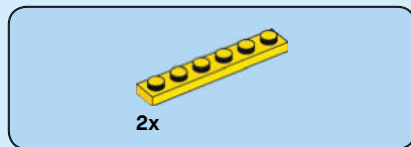
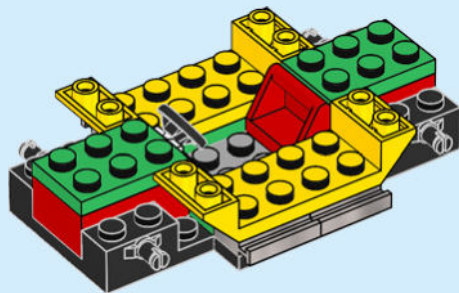

9

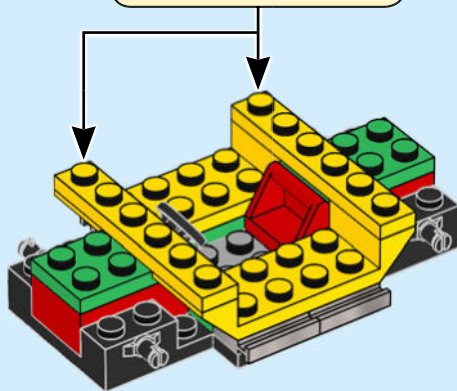
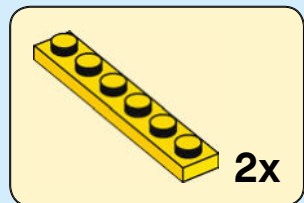



4x

10

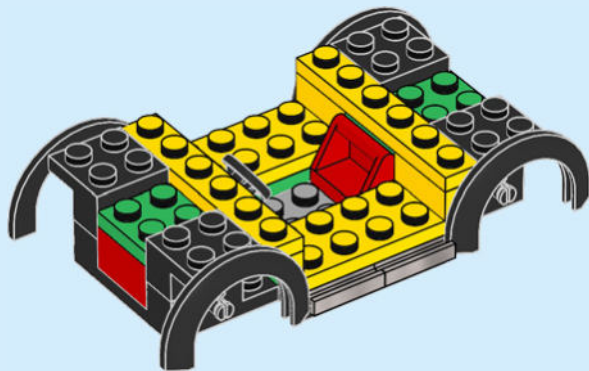

12

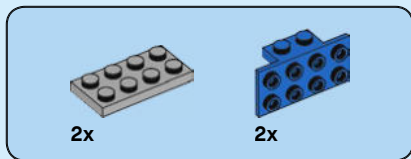

11

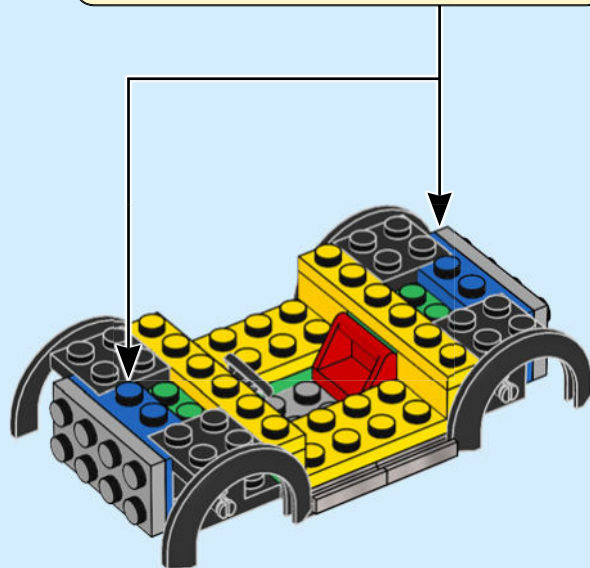
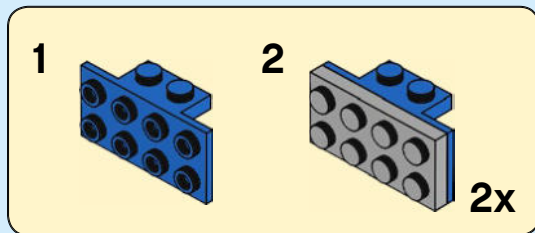

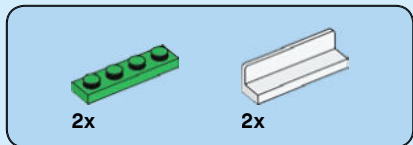

12

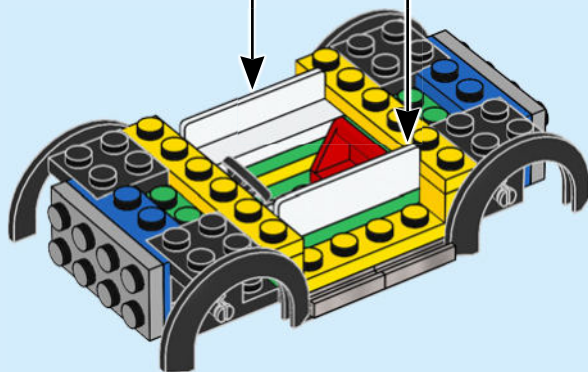
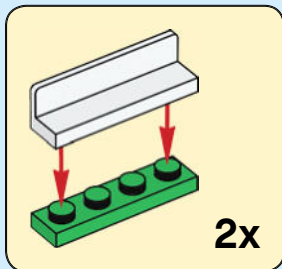

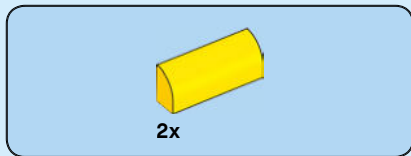

13

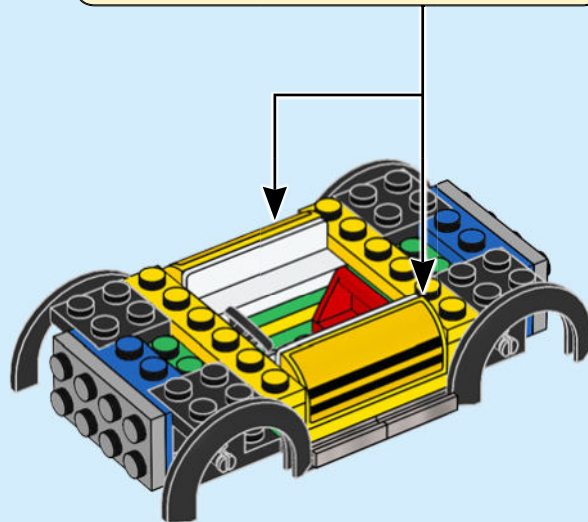
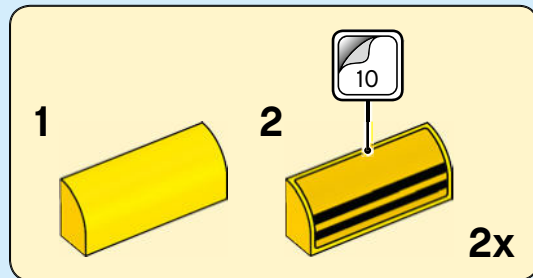



2x

14

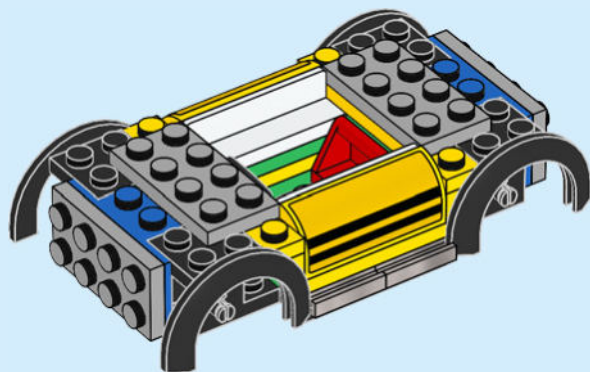

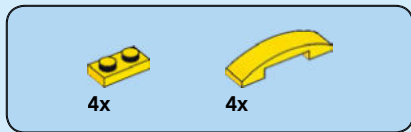

15

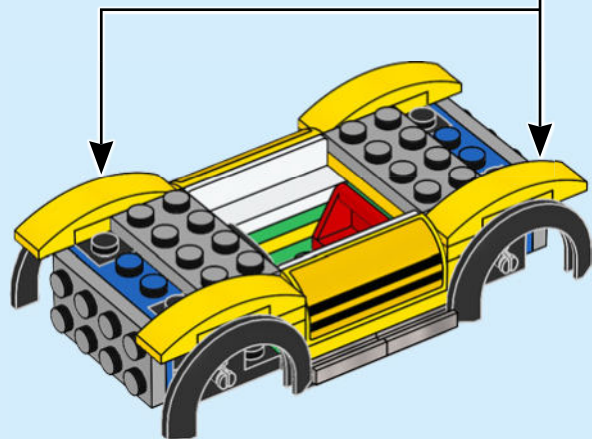
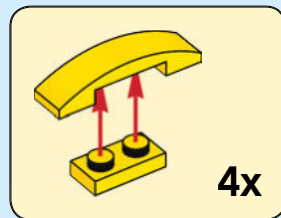



2x

16

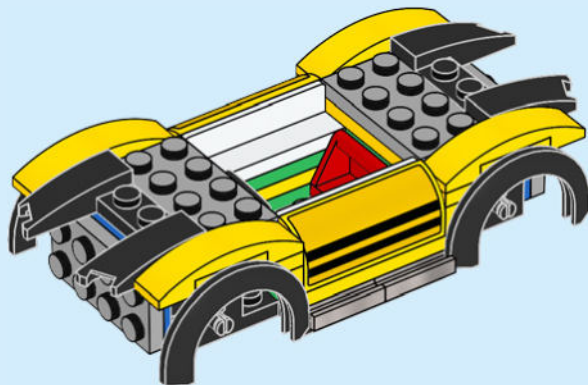

18

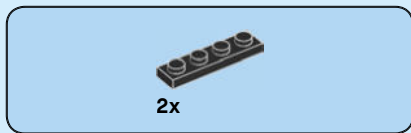

17

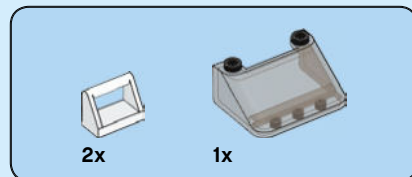
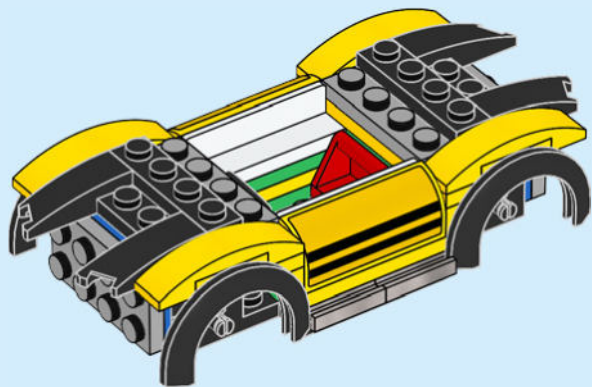

18

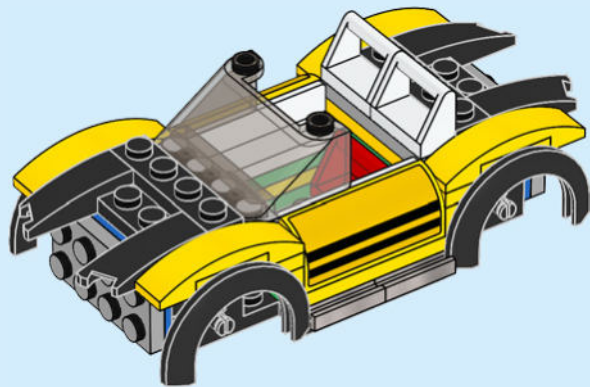



2x

19

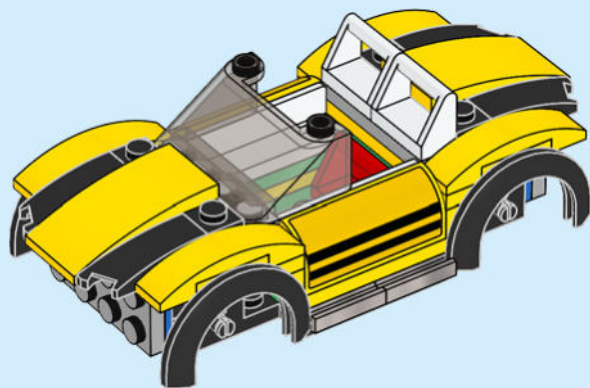

20

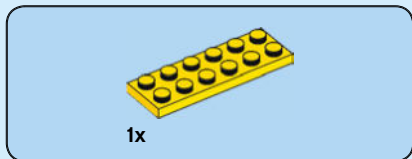

20

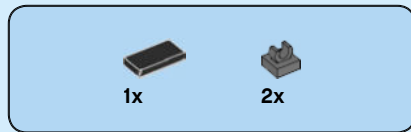
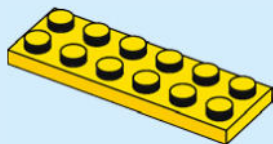

21

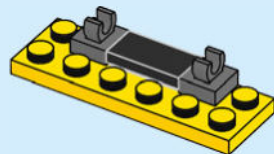



2x

22

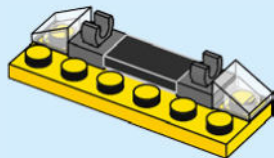

22



1x

23

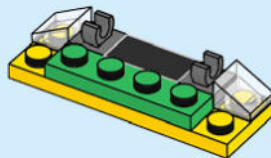



2x

24

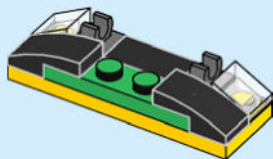

1x

25

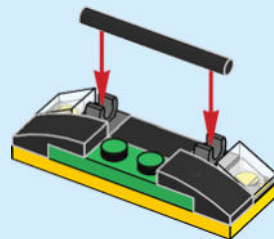



1x

26

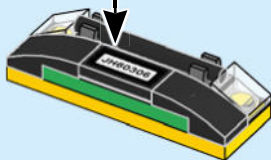
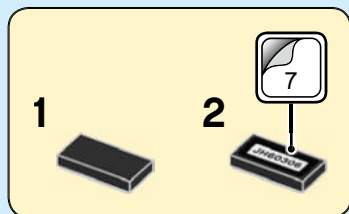

27

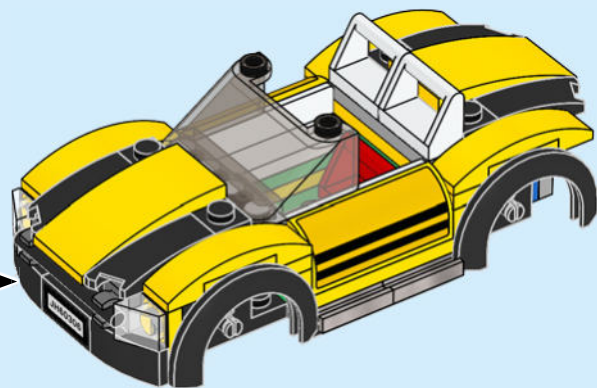

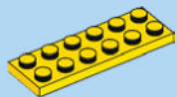

1x

28

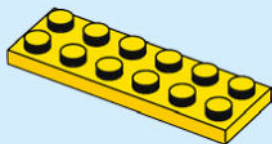

1x

29

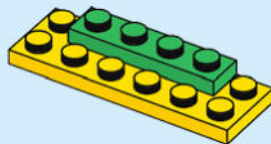



2x

30

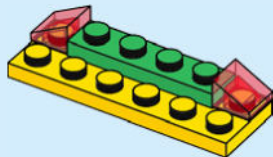

1x

31

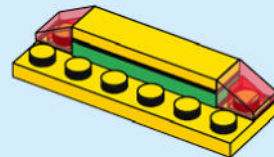



2x

32

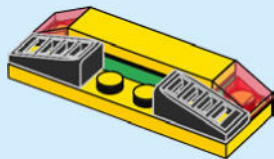

2x

33

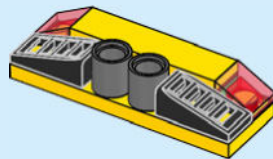

34

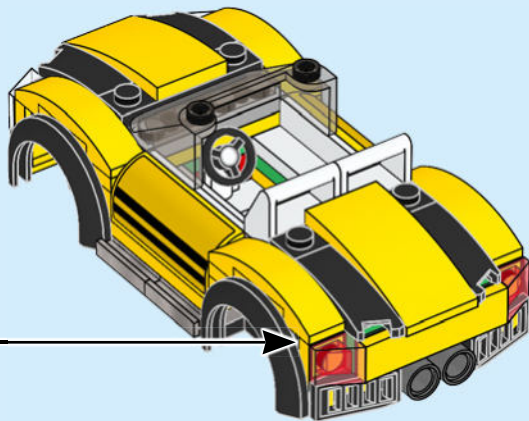
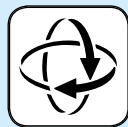



35

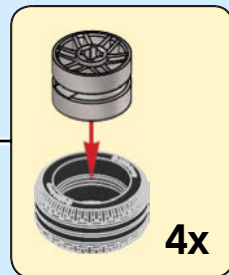
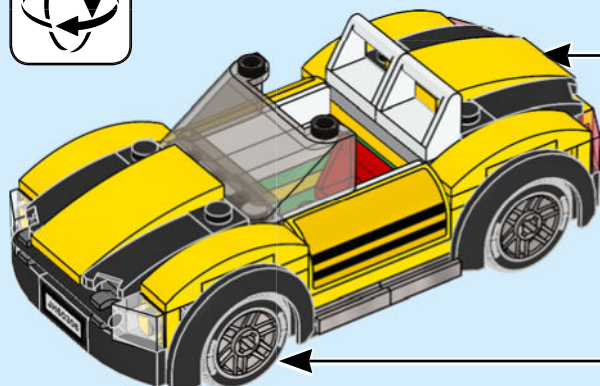
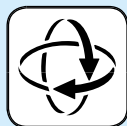

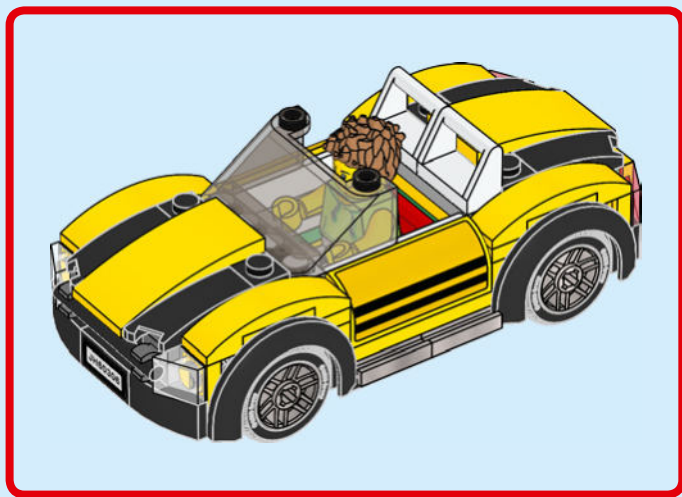

CITY ADVENTURES

City Abenteuer
Aventuras en City
City Aventuras
City kalandok
City piedzivojumi
乐高城市大冒险



VITO

60242



**SAM
GRIZZLED**

60243



**SNAKE
RATTLER**

60243 · 60276



**ROOKY
PARTNUR**

60244



**FRANKIE
LUPELLI**

60244 · 60277



**TOM
BENNETT**

60245



**BIG
BETTY**

60245



WHEELER

60246



**DAISY
KABOOM**

60246



**CLARA
THE CRIMINAL**

60276



**GRACIE
GOODHART**

60277



**DUKE
DETAIN**

60242 · 60246 · 60276



**FREYA
MCLOUD**

60248 · 60280



CLEMMONS

60247 · 60281



BOB

60282



FELDMAN

60282



**TREAD
OCTANE**

60258



**HARL
WIBBS**

60258 · 60266



**SHIRLEY
KEEPER**

60292



MADISON

60292



CITY

60306



2

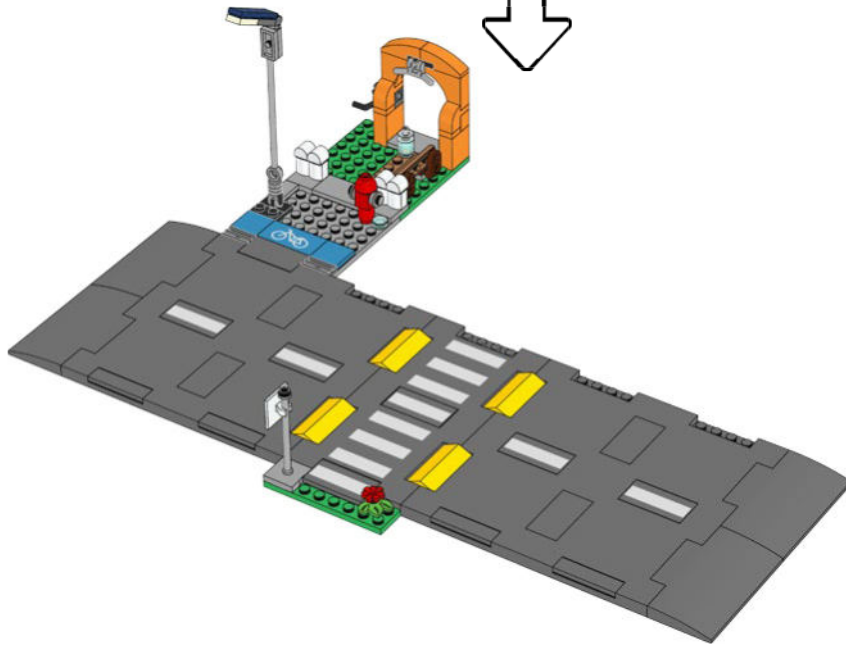
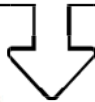
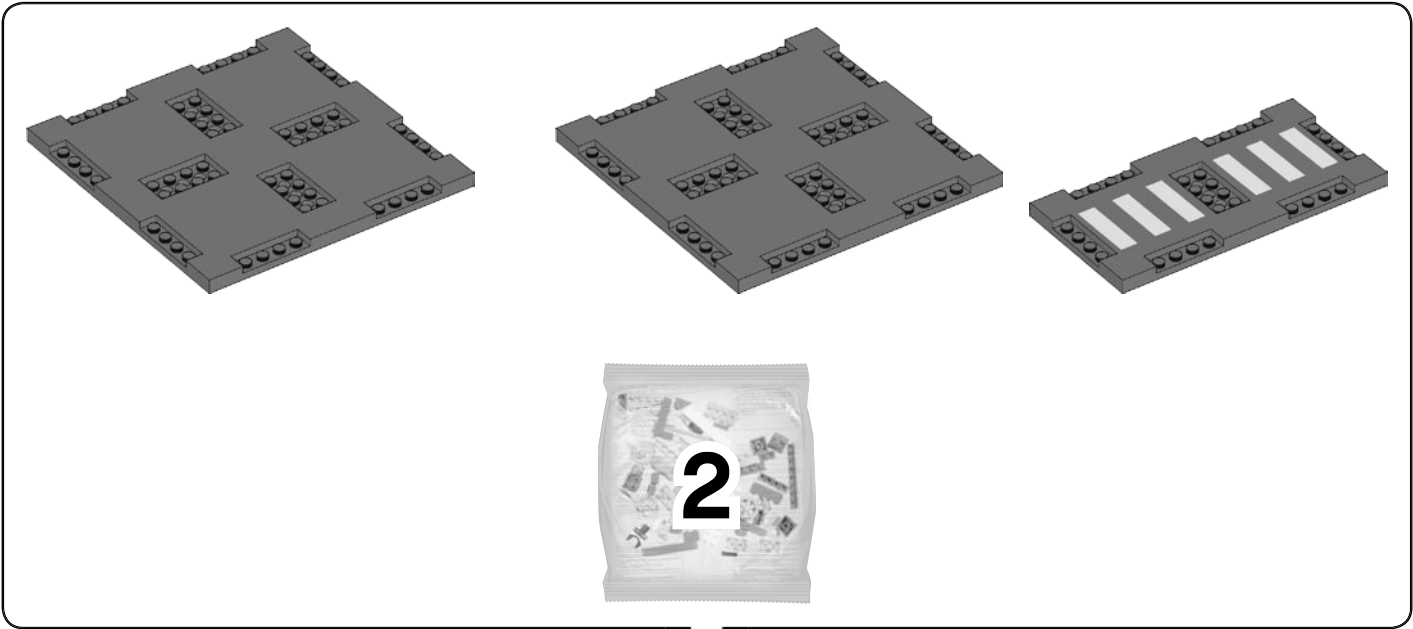

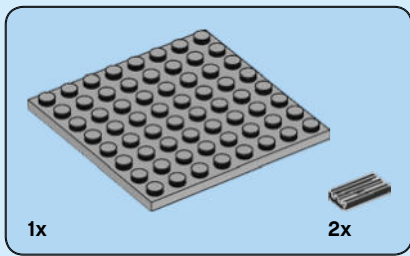

1

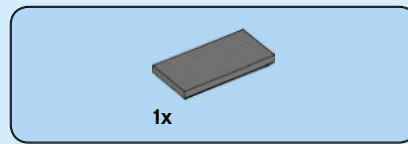
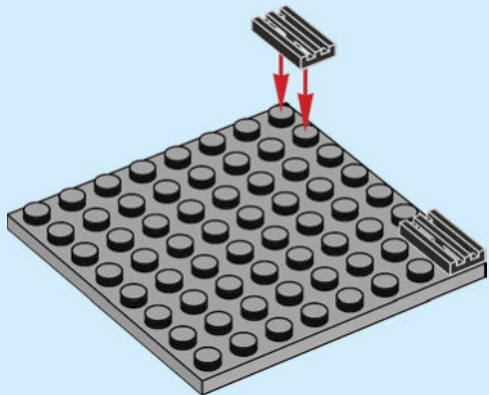

2

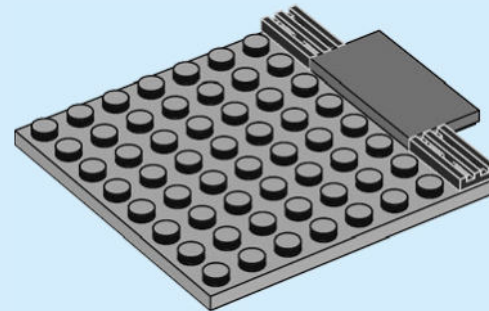

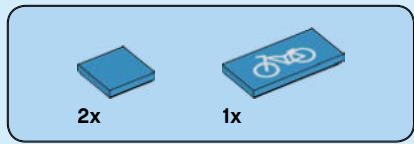

3

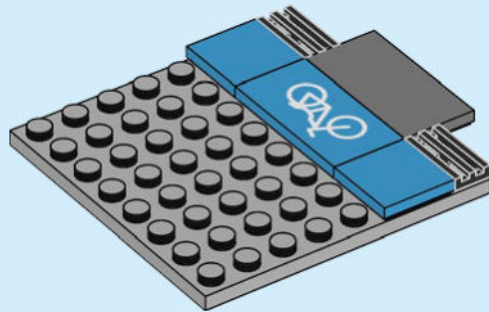

4

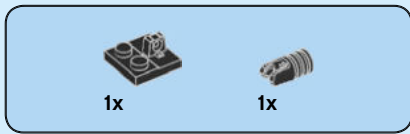

4

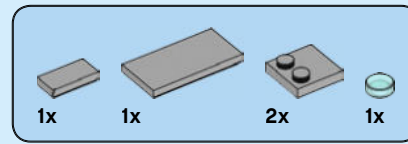
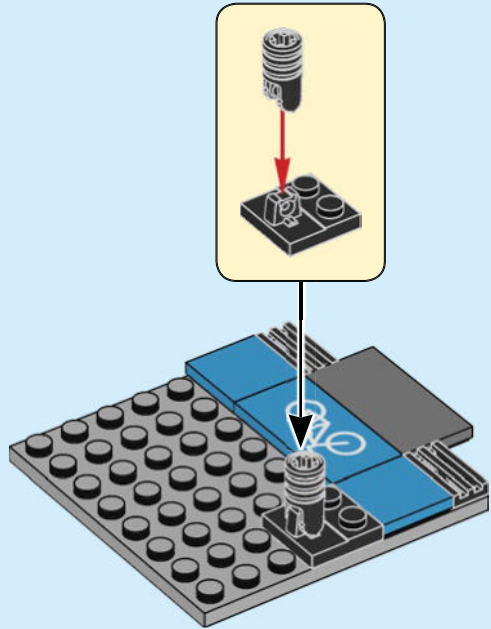

5

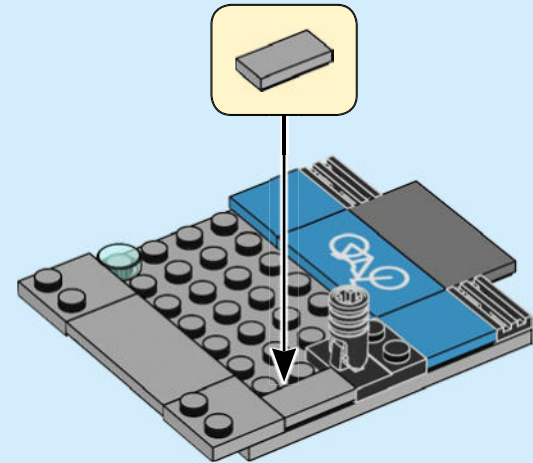

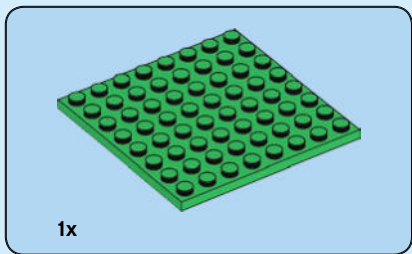

6

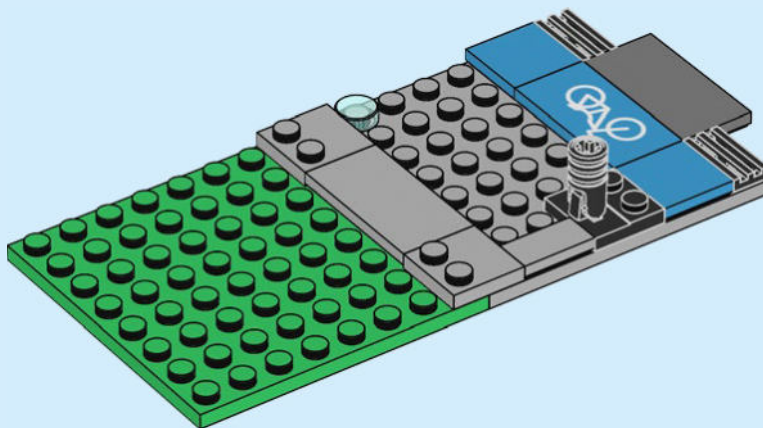



7

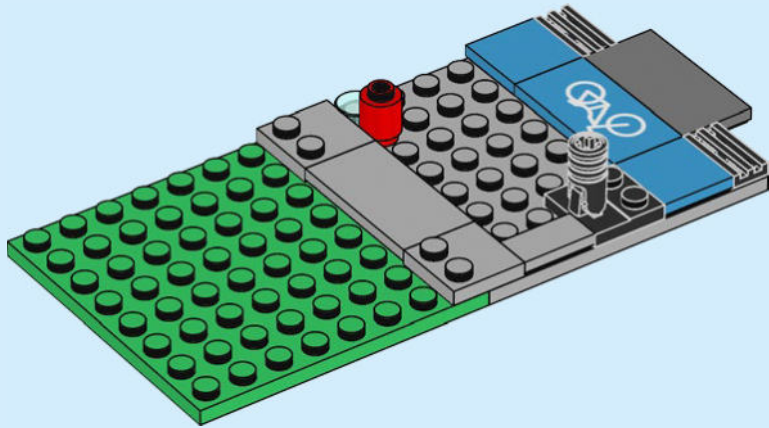

8

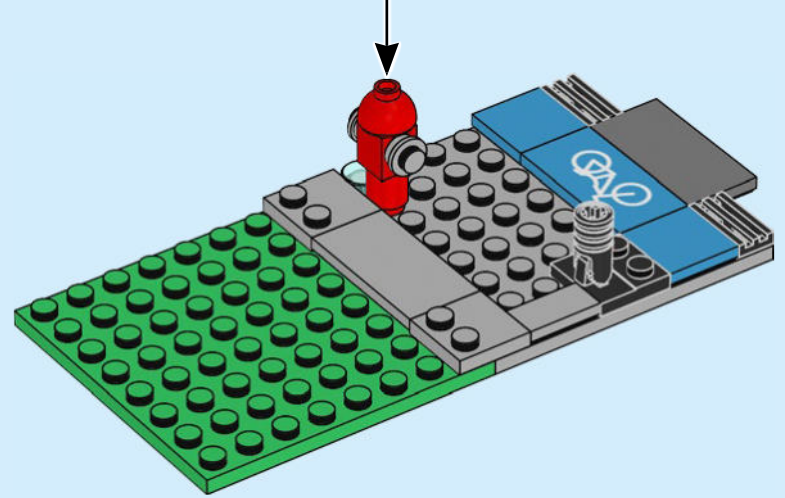
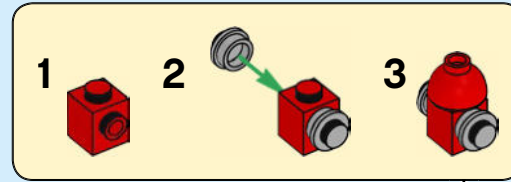

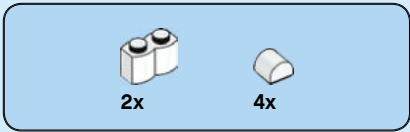

9

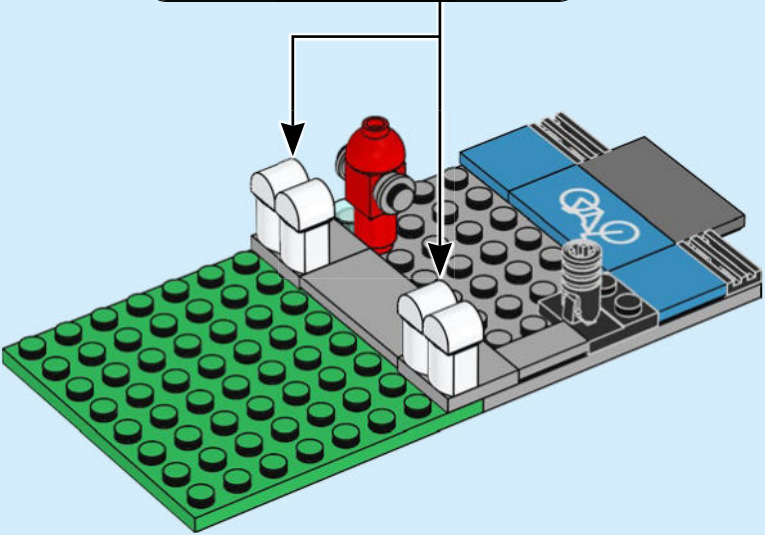
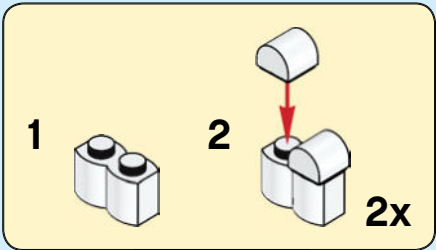

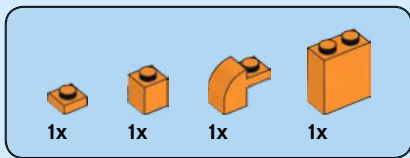

10

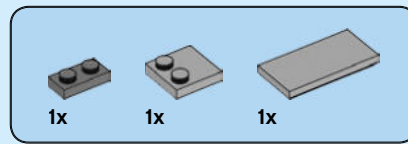
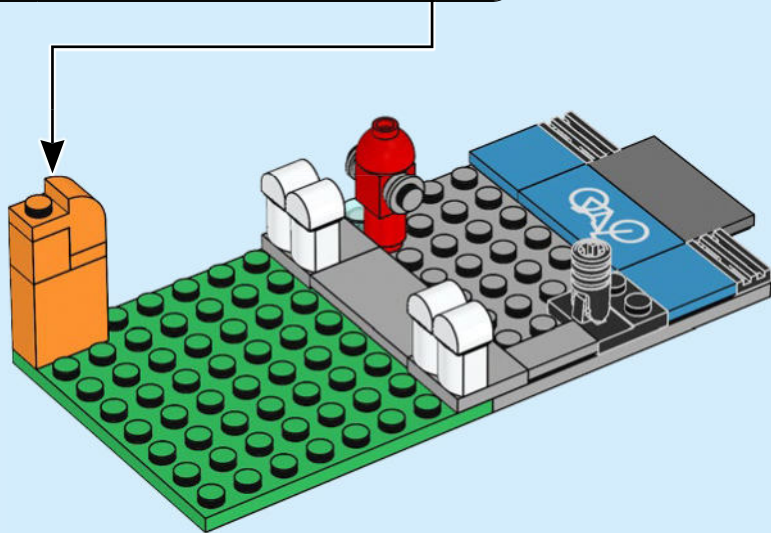
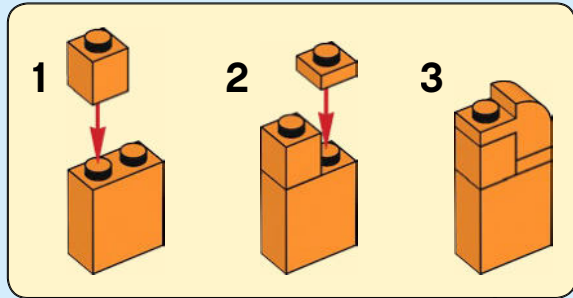

11

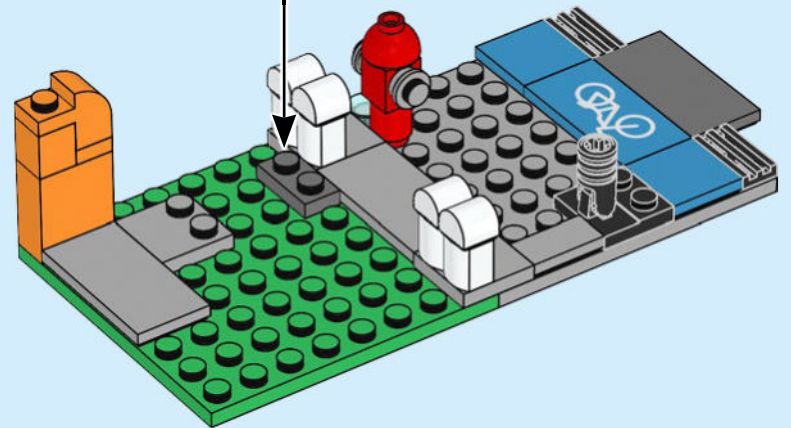

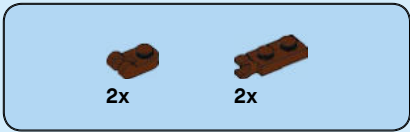

12

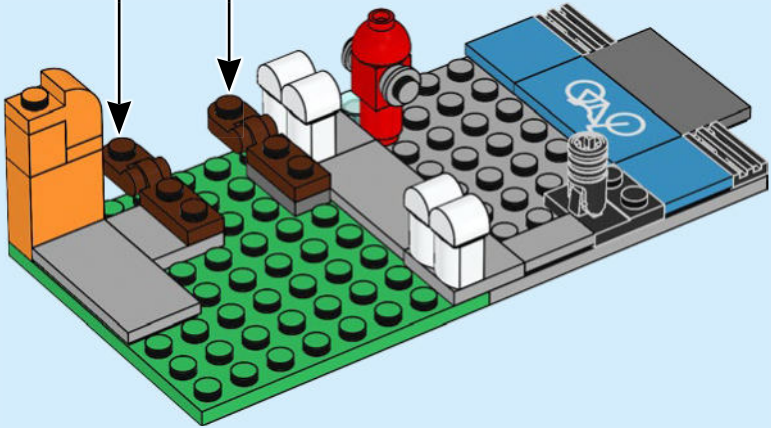
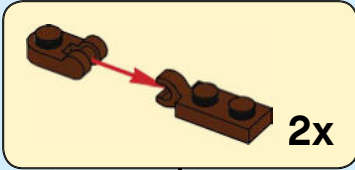

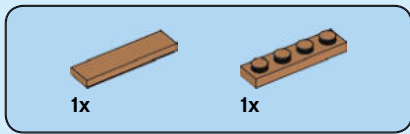

13

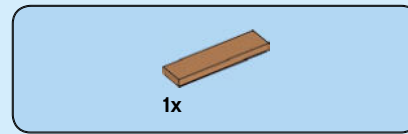
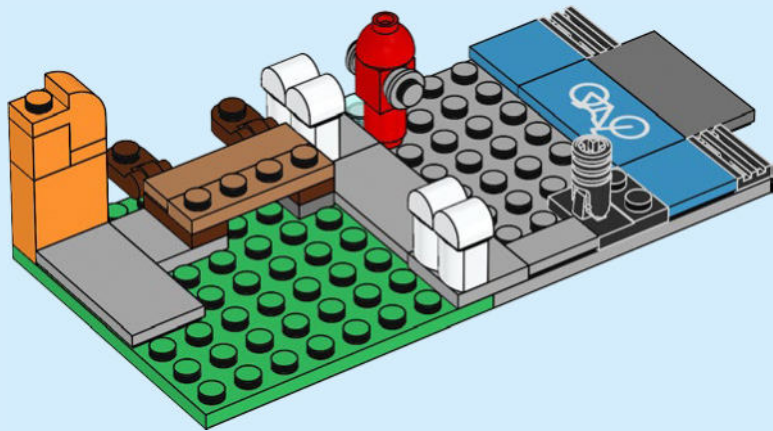

14

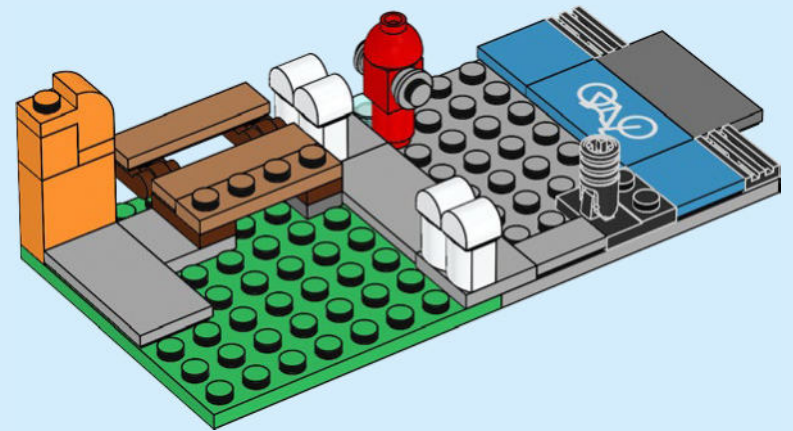



1x



1x

15

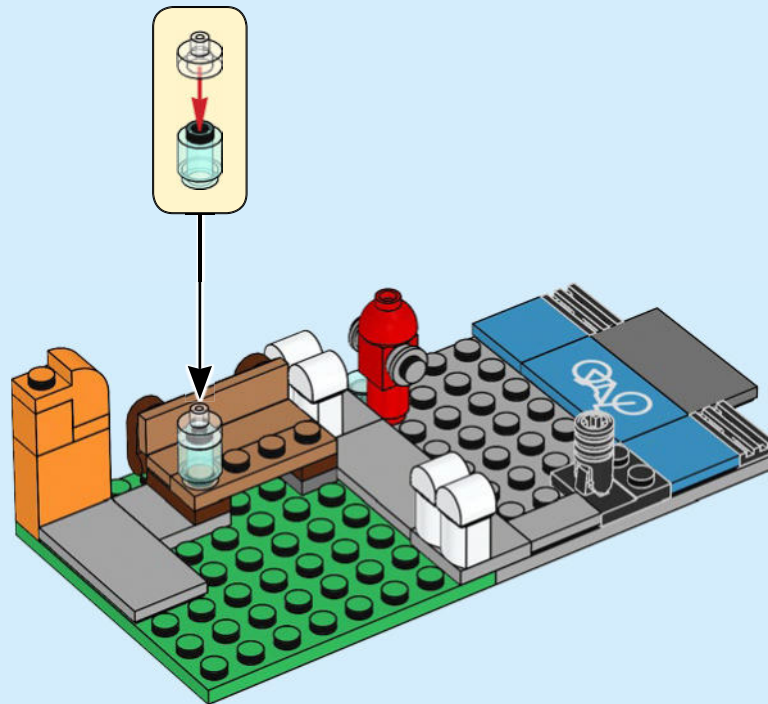

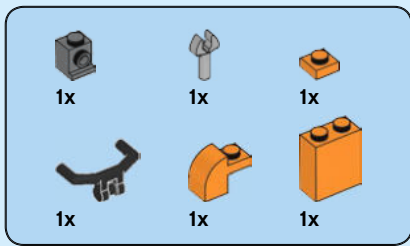

16

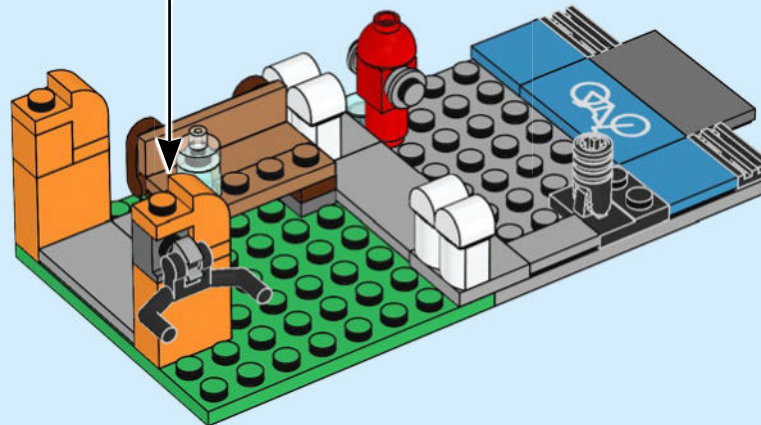
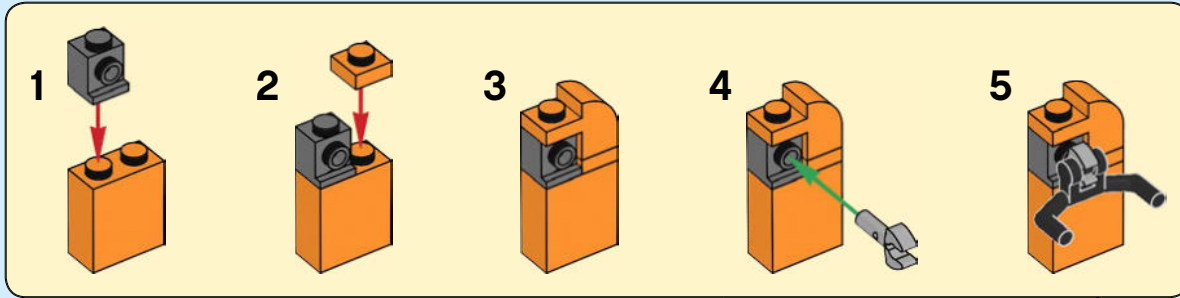

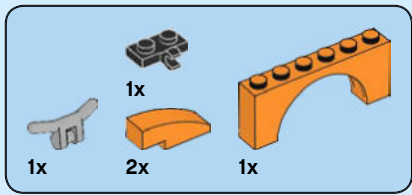

17

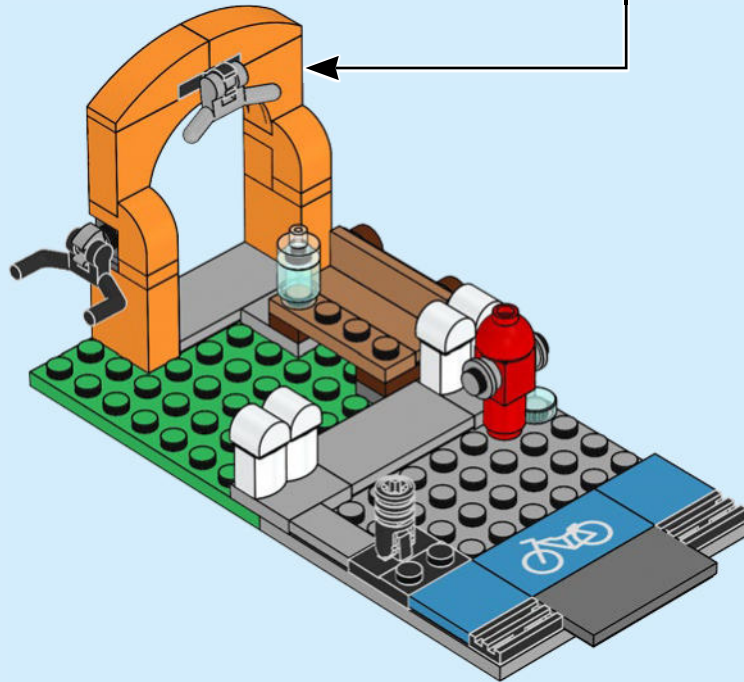
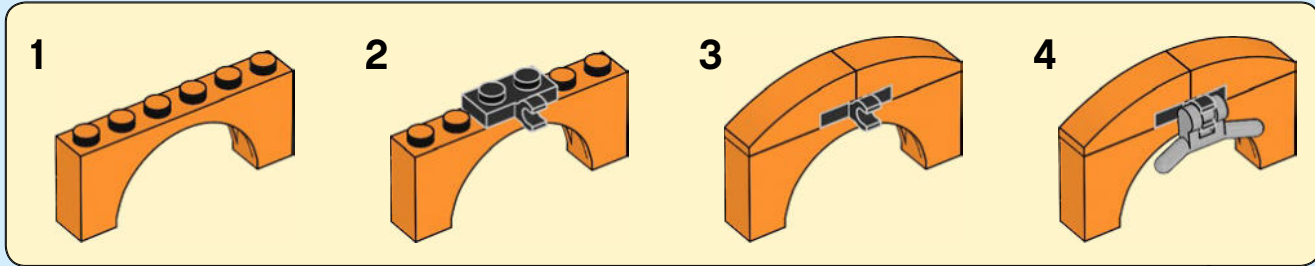

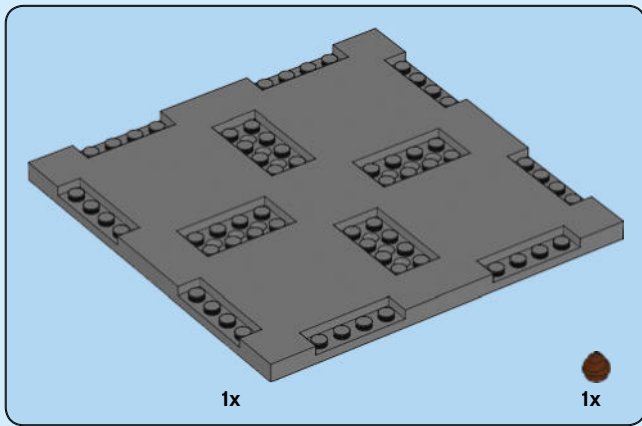

18

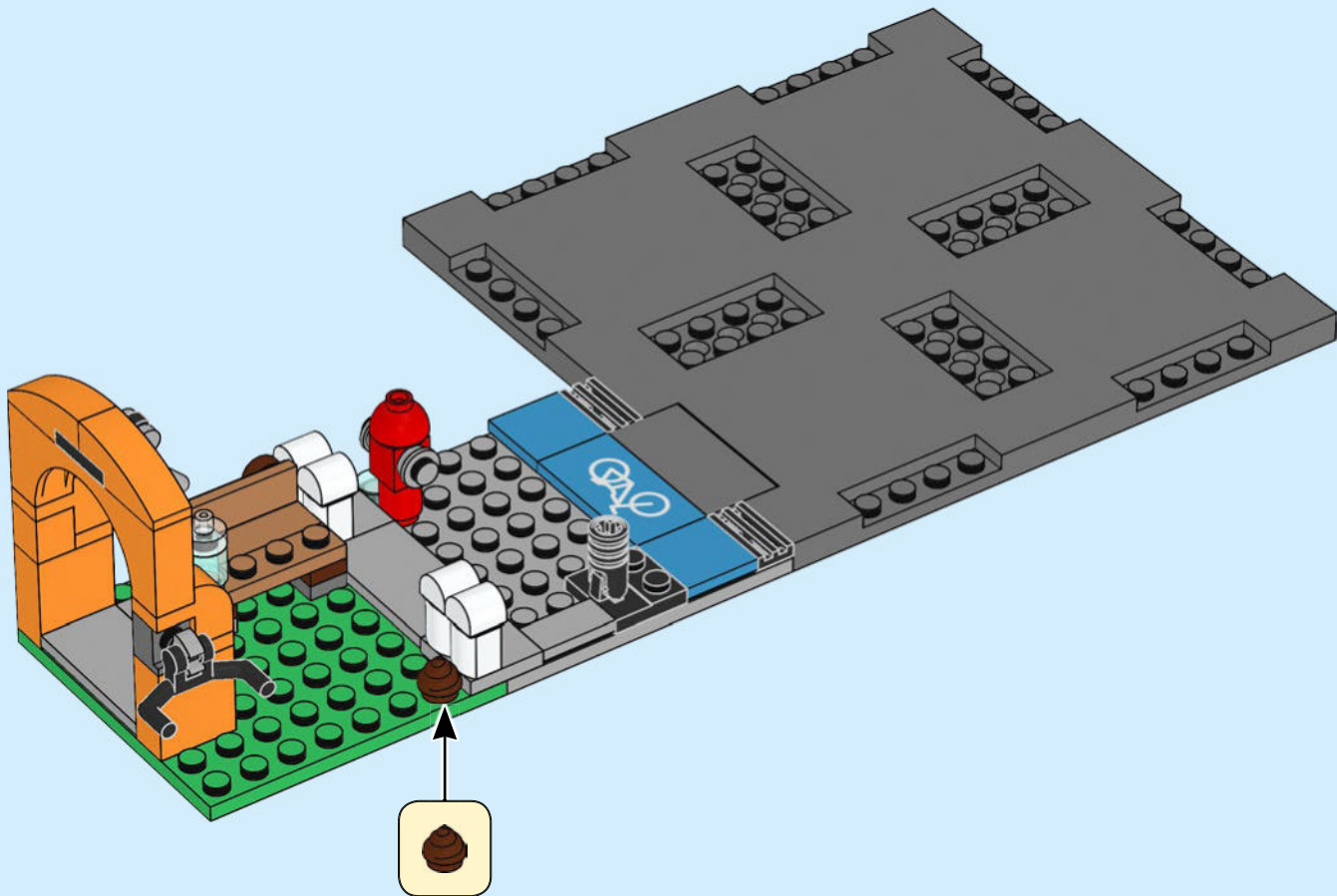

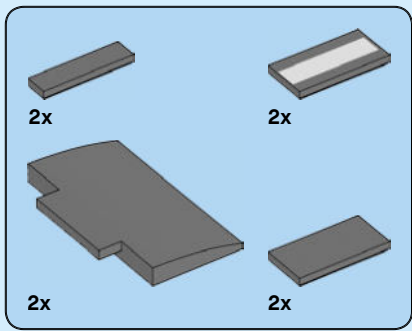

19

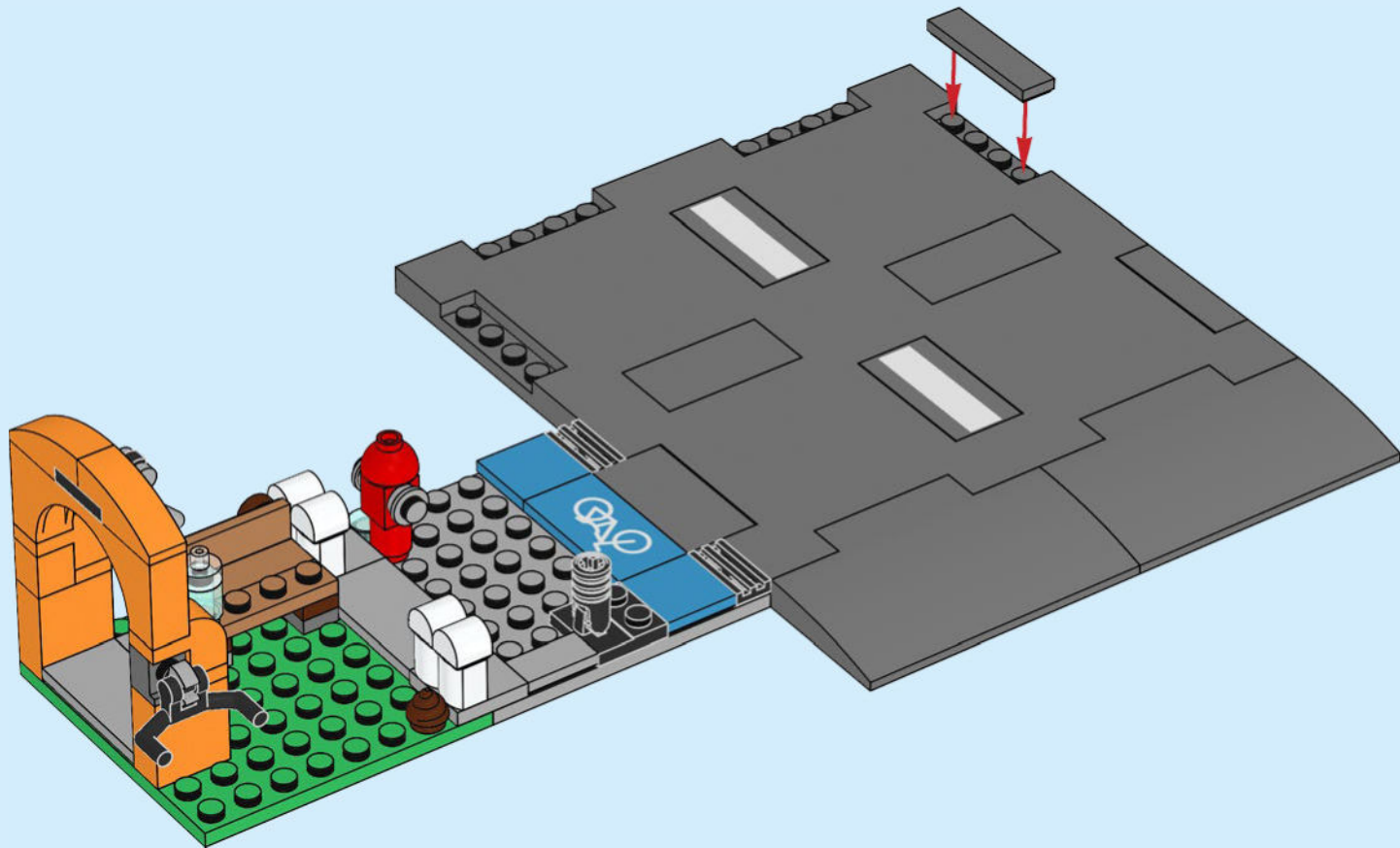

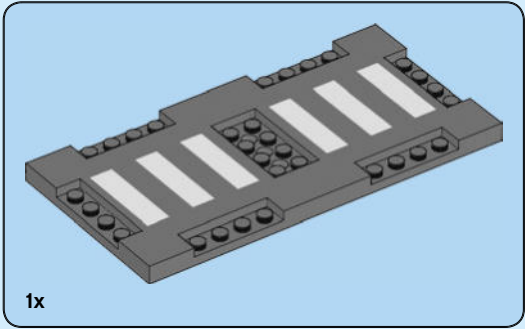
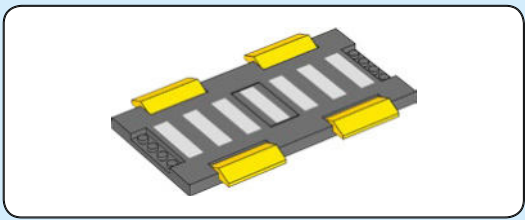

20

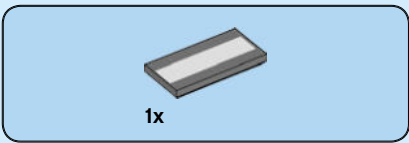
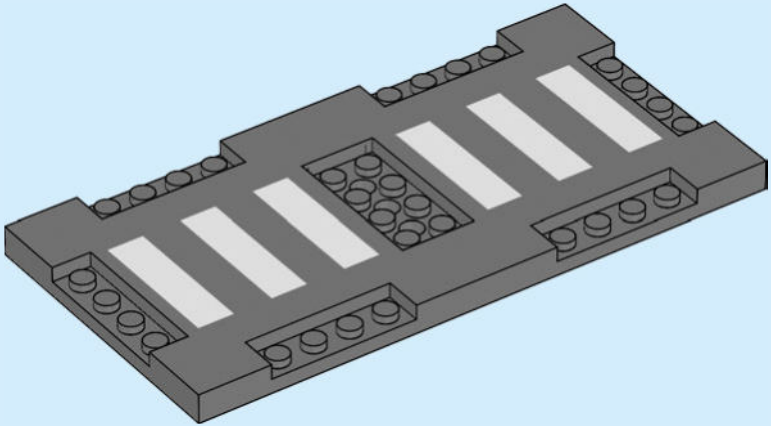

21

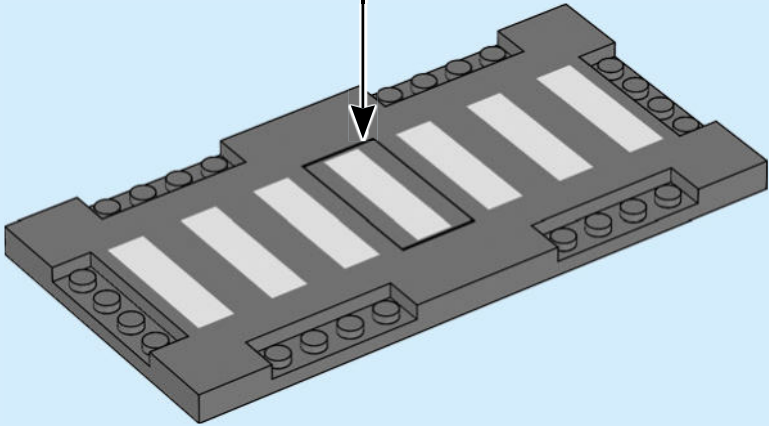
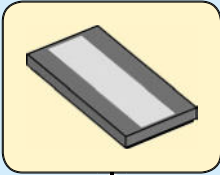

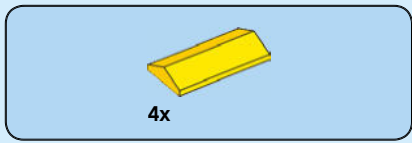

22

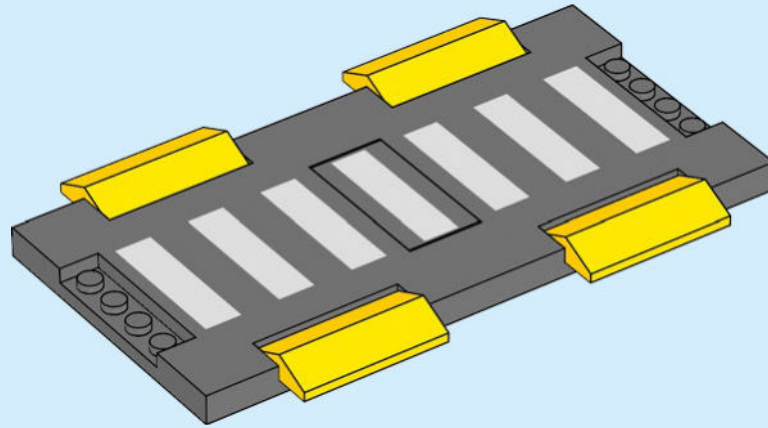

23

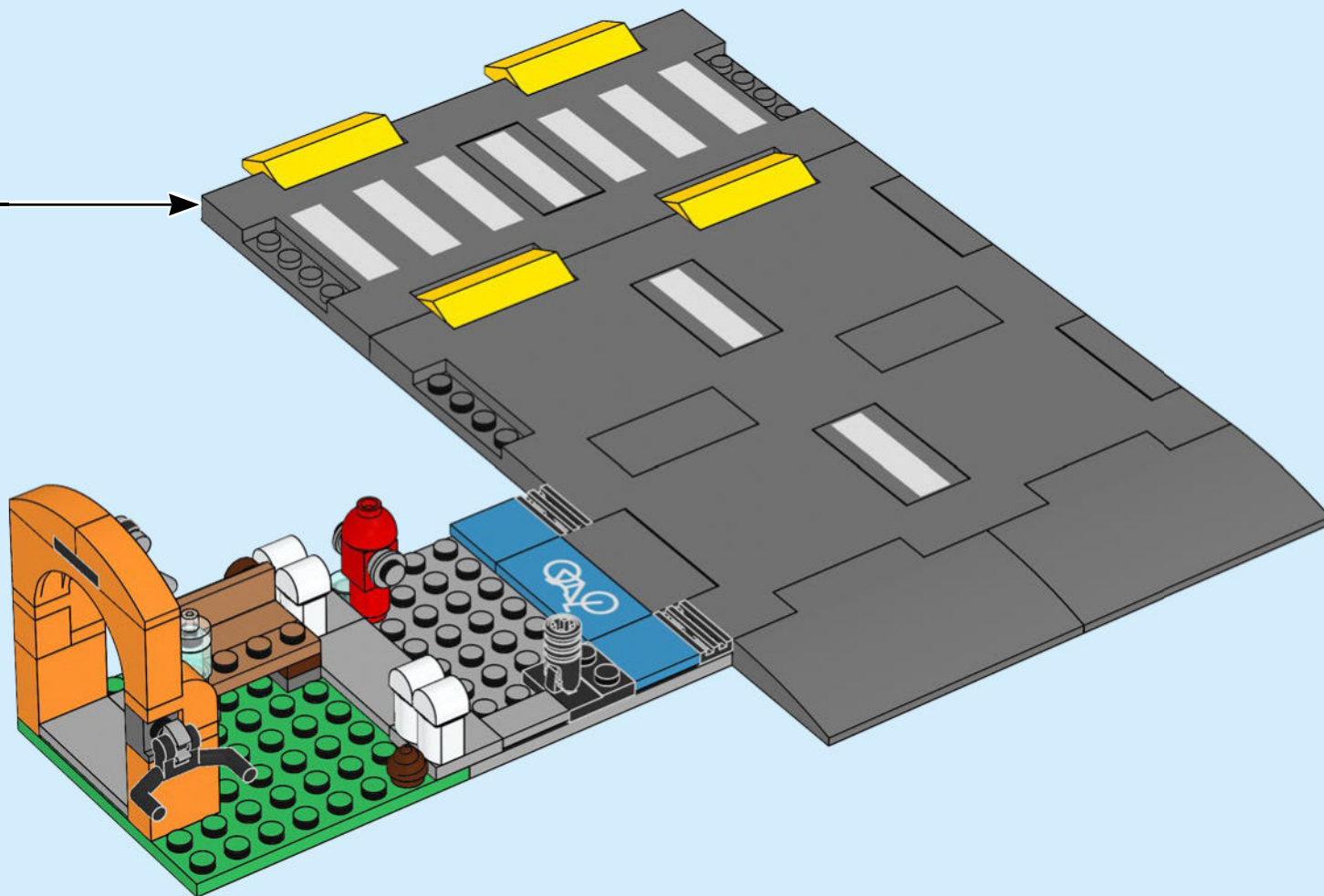

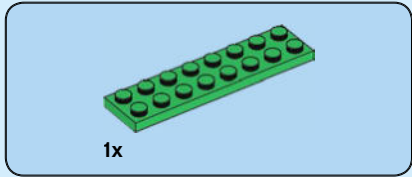
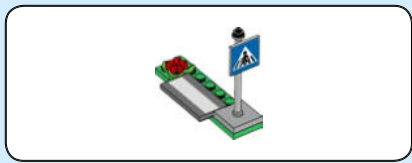

24

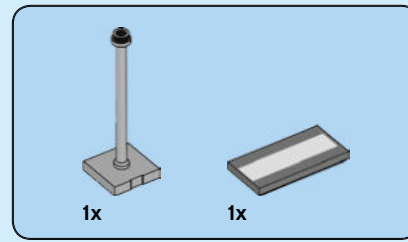
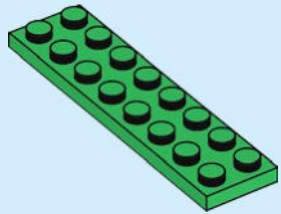

25

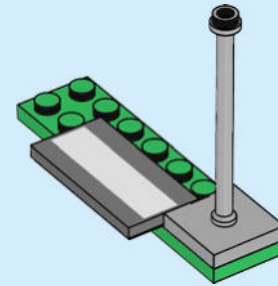



26

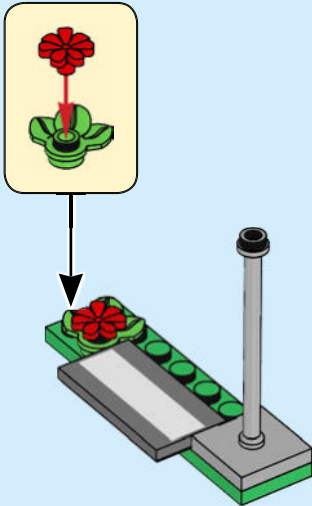

27

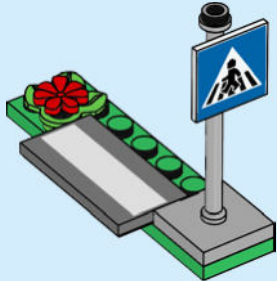

28

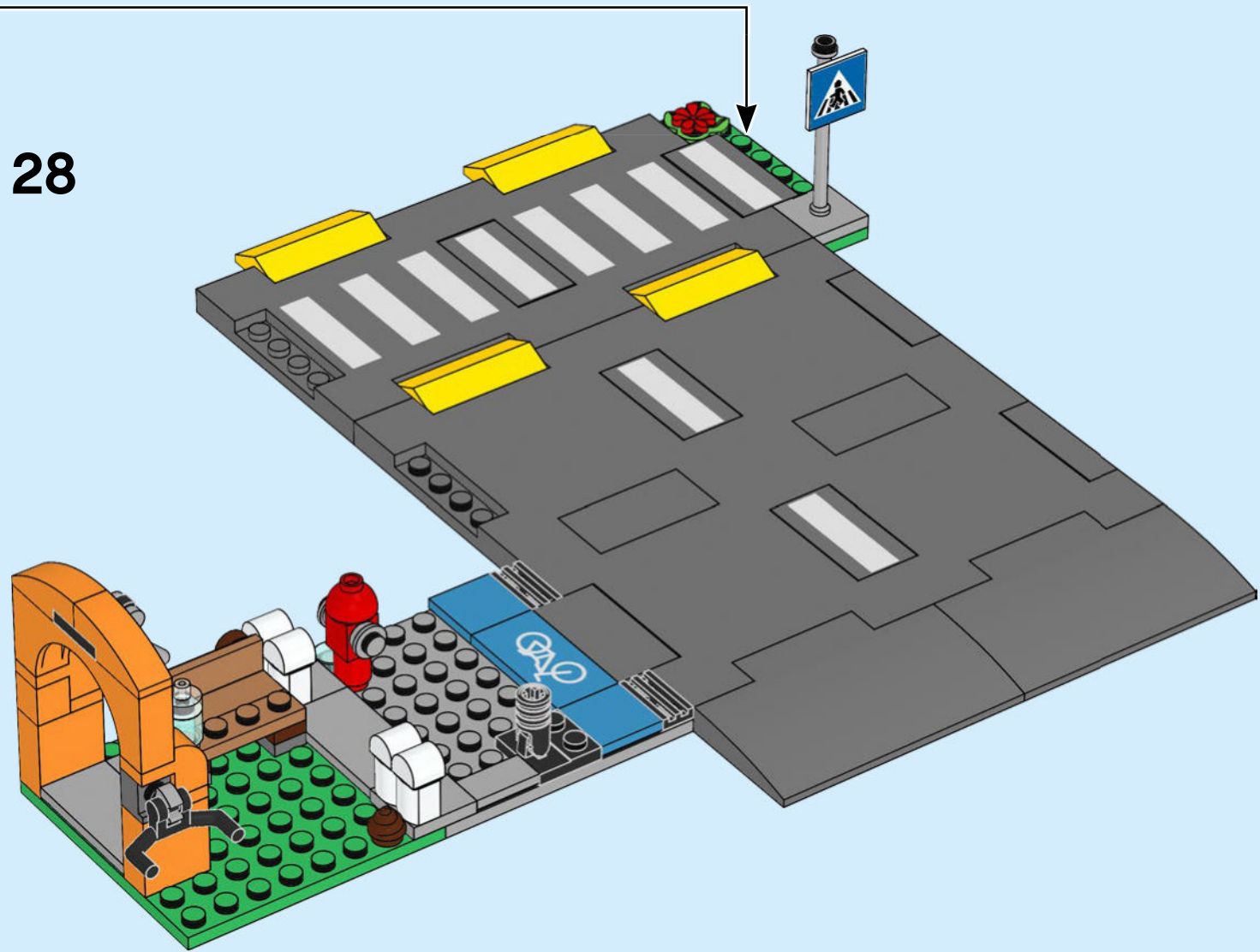

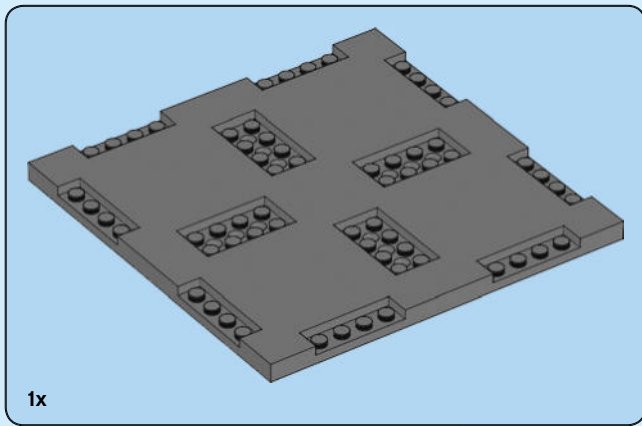

1x

29

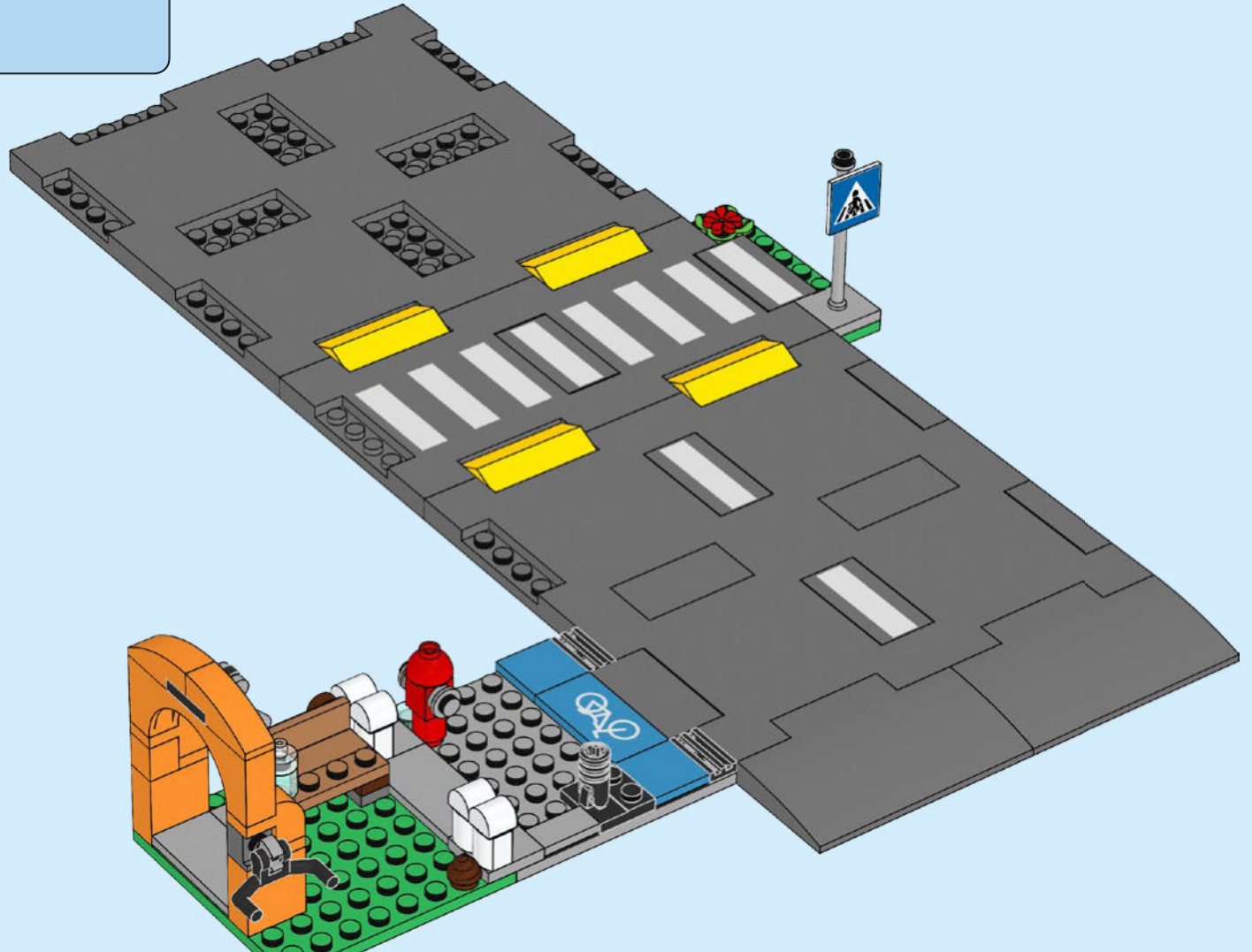

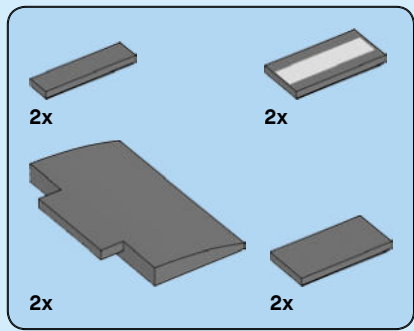

30

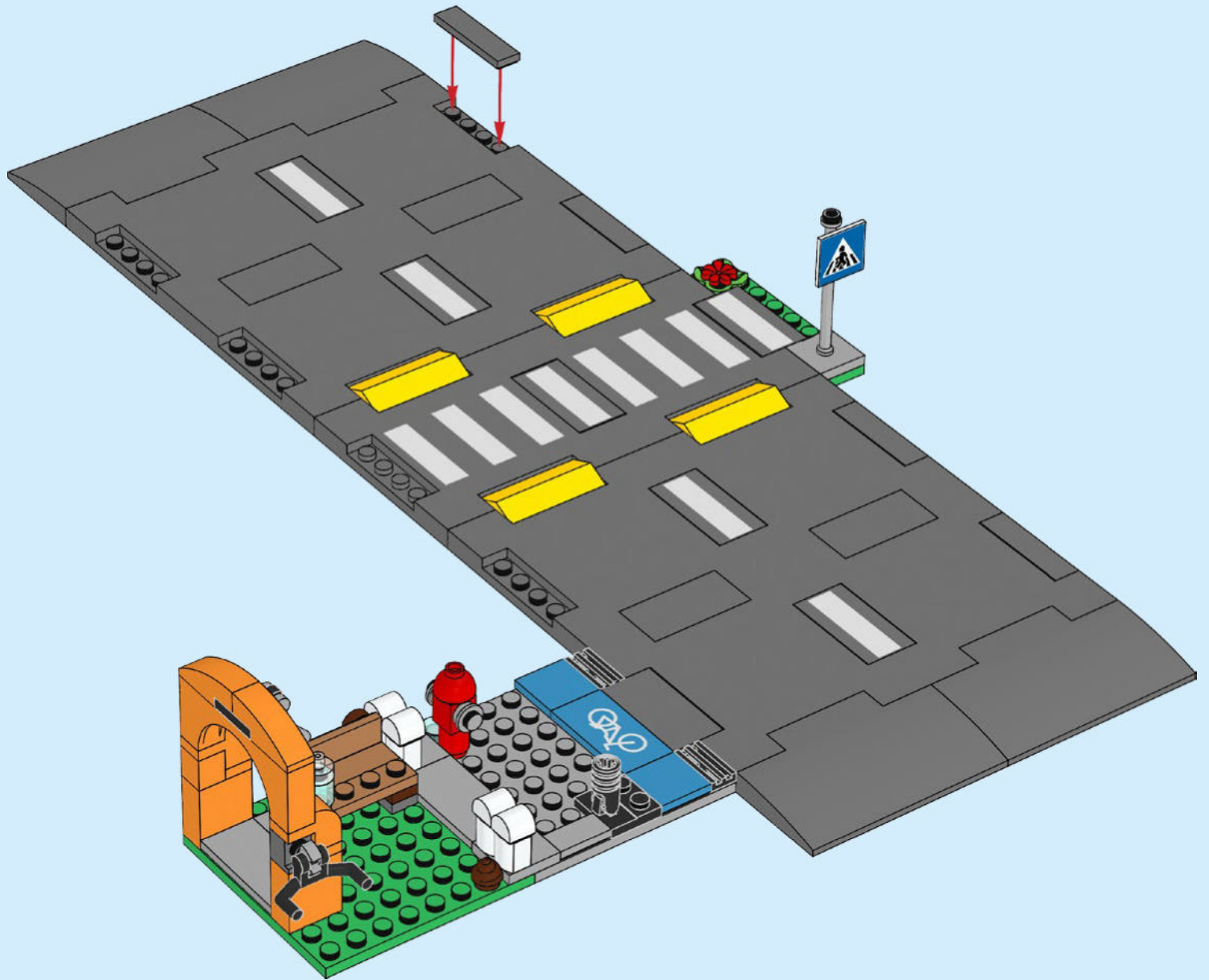

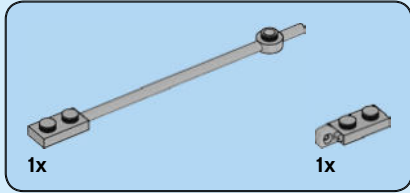
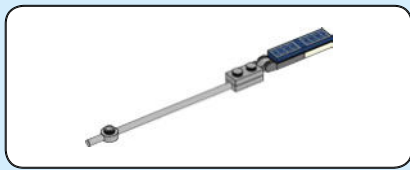

31

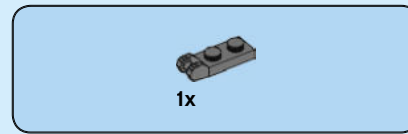
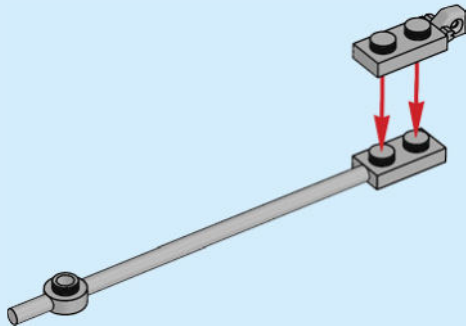

32

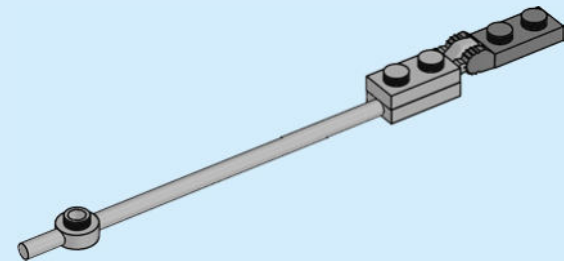

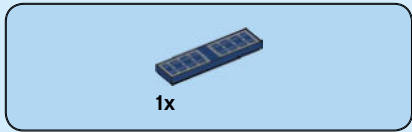

33

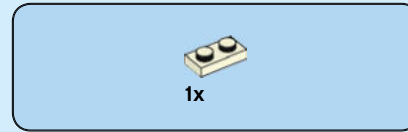
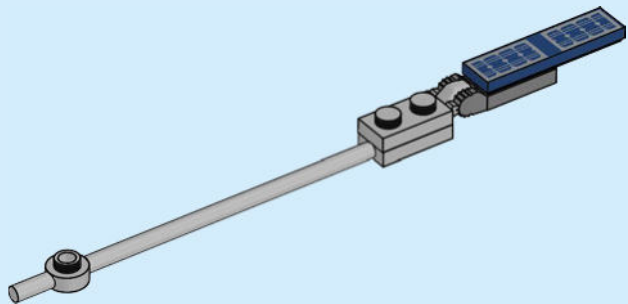

34

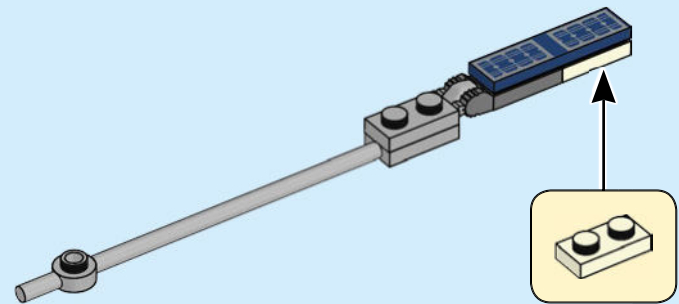

35

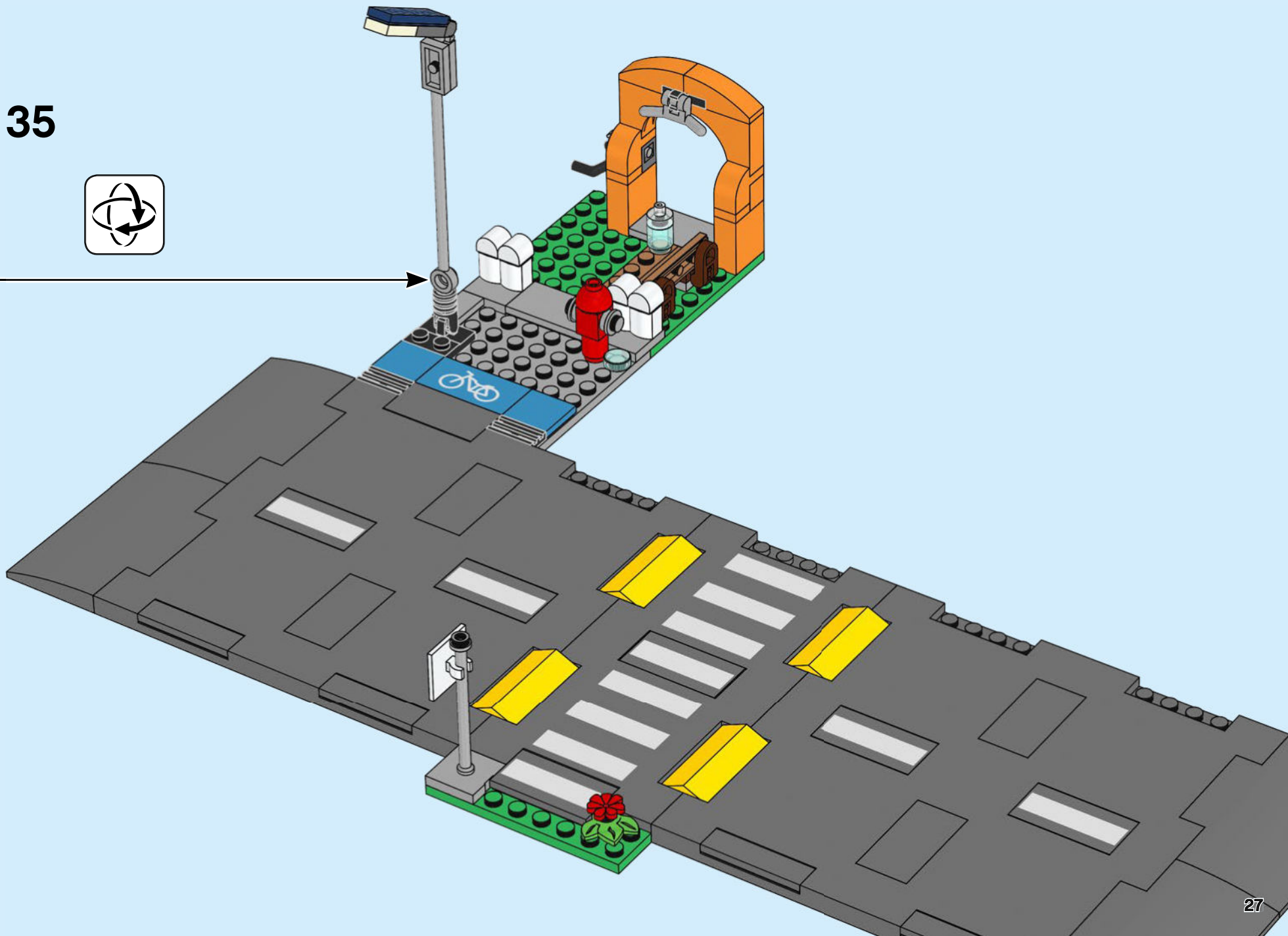

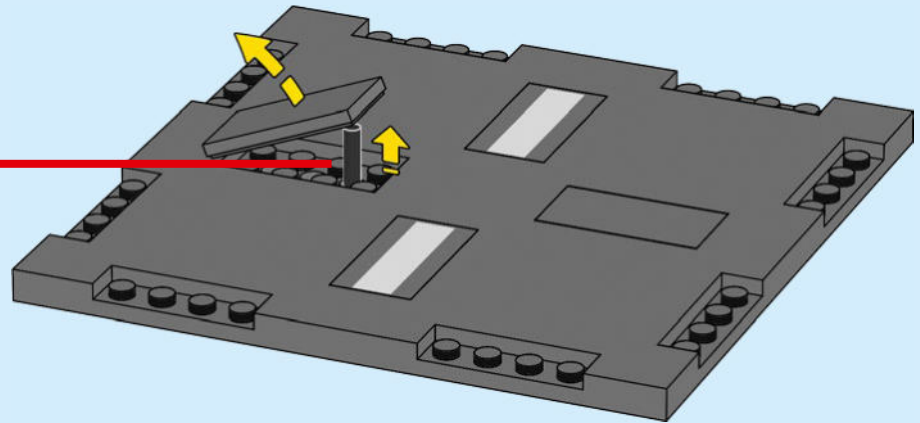
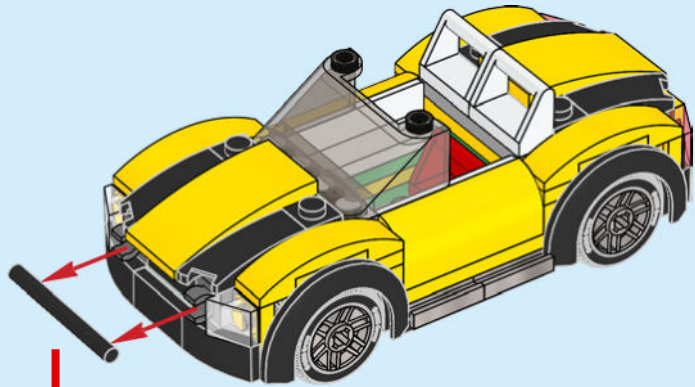

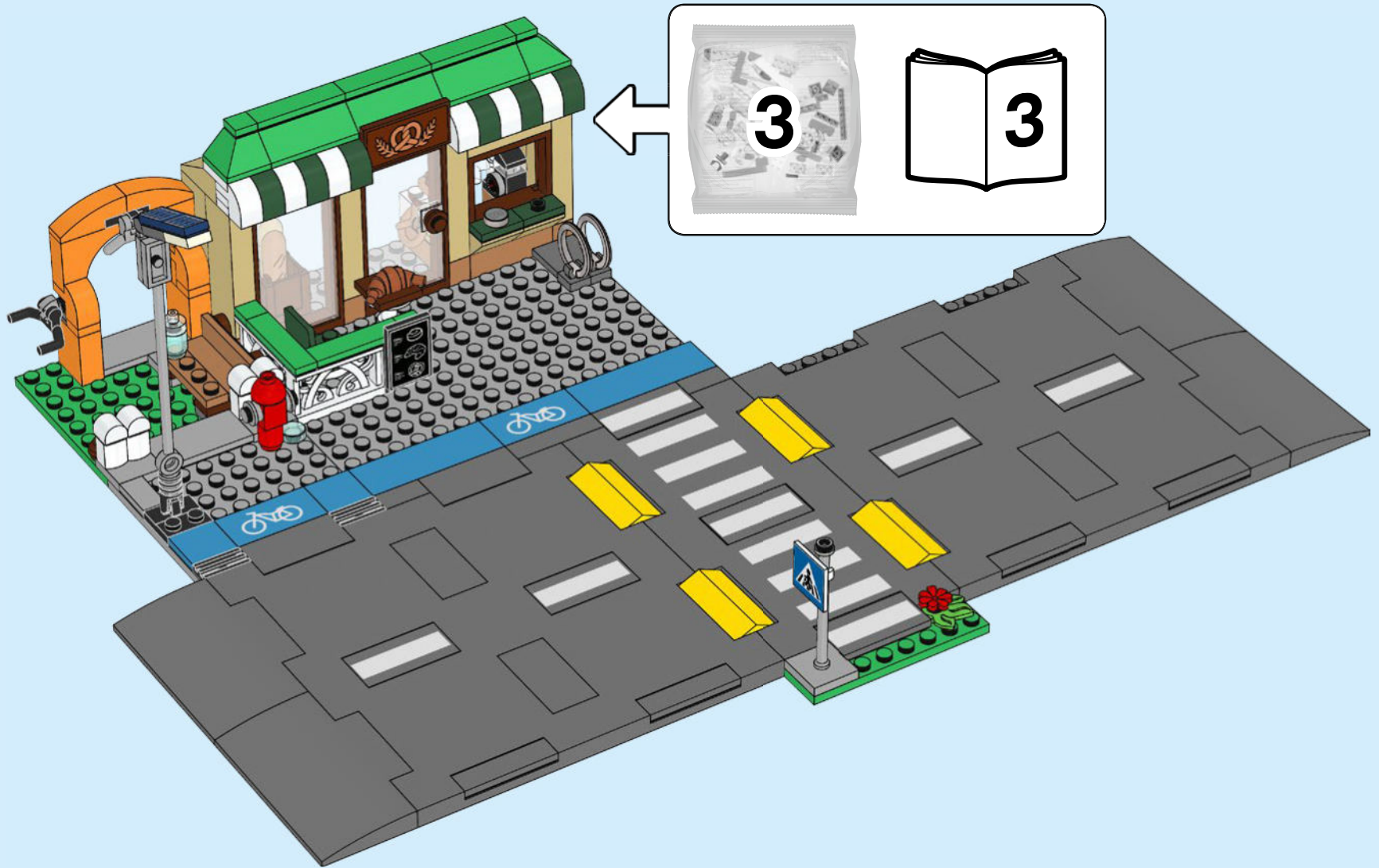

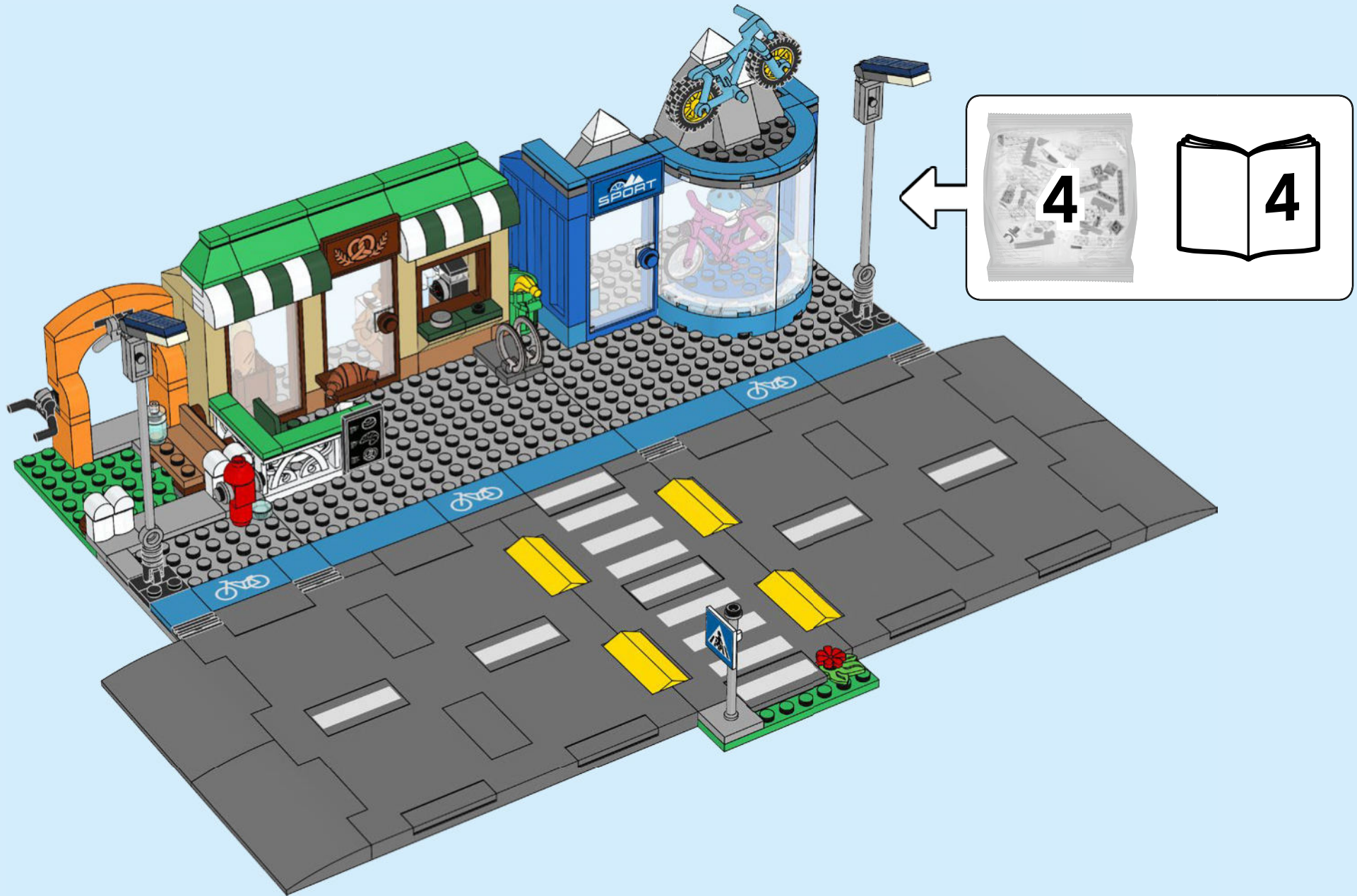







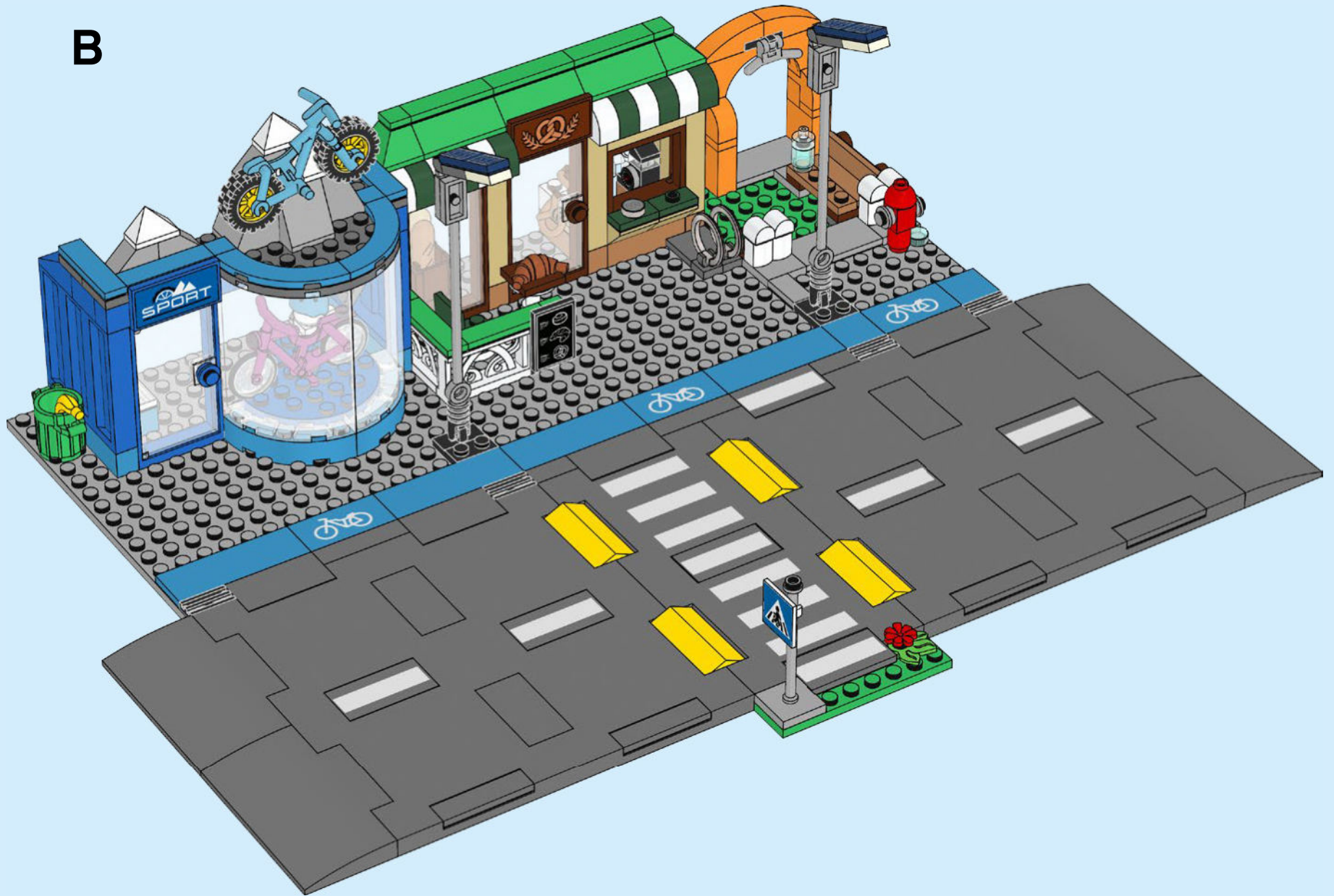





A















B



							
2x 4112980	2x 4190219	1x 300921	1x 614123	1x 6155272	4x 302324	1x 4558954	2x 6064174
							
1x 6092587	1x 6030266	3x 366621	1x 9341	1x 6153138	2x 302224	1x 6329579	8x 6029208
							
4x 4114064	2x 6345429	1x 4259903	3x 300423	1x 6219611	2x 408324	2x 6196548	2x 371026
						2x 6330189	
1x 6214334	1x 6177507	2x 428623	1x 243223	1x 6192789	4x 4613151	2x 6271535	2x 6179660
						2x 4541191	
2x 4118866	3x 302321	2x 6194751	1x 9566	1x 243124	2x 6057986	2x 6313116	1x 366626
			1x 6252060			1x 6313116	
2x 4118866	6x 300421	1x 6262960	1x 6328341		2x 6192835	3x 6047276	1x 6058118
			1x 6100249	1x 6338029	1x 6163633	1x 6047276	
2x 6058090	1x 243221	1x 4560180	1x 4651443	4x 6334233	1x 4569382	6x 241226	1x 4517986
			1x 6283875	2x 6079001	1x 6226646	1x 6330197	1x 379526
1x 4582437	1x 4537986	1x 4560180	1x 6153321	4x 366624	1x 6218360	1x 4618852	
	2x 6105976	2x 6132335	1x 6174454	2x 379524	1x 6218360	3x 306926	
1x 4113916	2x 6105976	2x 6132335	1x 6174454	4x 366624	1x 6218360	1x 4618852	1x 6265688
	2x 366021	1x 6096711	1x 6153321	2x 379524	1x 6218360	1x 4618852	
1x 306221	2x 366021	1x 6096711	1x 6153321	2x 379524	1x 6218360	3x 306926	
	1x 4288209	1x 6096711	1x 6174454	2x 302424	1x 6218360	2x 302326	
1x 6182260	1x 4288209	1x 6096711	2x 302424		2x 6187006	2x 302326	1x 395826
	4x 300221	1x 6096711	1x 4114584	1x 4114584	2x 6187006	2x 302326	
1x 6173572	4x 300221	1x 6096711	1x 4114584	2x 6146800	2x 6102998	2x 6342135	
	1x 243121	1x 6057905	2x 6338002	2x 4514844	4x 6223183	1x 6271542	
1x 6337734	1x 243121	1x 6057905	2x 6338002	2x 4514844	4x 6223183	1x 6271542	
1x 6177505	1x 243121	1x 6057905	2x 6338002	2x 4514844	4x 6223183	1x 6271542	

 2x 302226
 2x 6265730
 4x 6092658
 1x 452226
 1x 6078610
 1x 6223896
 1x 400626
 1x 317626
 1x 6116604
 1x 6162892
 1x 302126
 4x 6170505
 4x 4260488











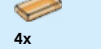

 4x 4558593
 1x 6182261
 3x 306928
 1x 4295260
 2x 300328
 2x 6234157
 1x 6171069
 2x 302128
 6x 371028
 5x 243128
 3x 4141737
 1x 303428
 1x 4161677













 1x 6329604
 2x 6207840
 4x 6218226
 2x 4619636
 4x 6132264
 1x 6338007
 1x 6093518
 1x 6303099
 2x 6258607
 2x 6245252
 1x 6138657
 1x 6341328

 1x 6186867
 4x 6245250
 1x 6252041
 1x 6238856
 3x 6163986
 2x 6246888
 2x 6236111
 1x 6256058
 1x 6256058
 2x 6247362
 1x 6255922

 2x 4524929
 1x 4173805
 2x 6112356
 2x 6078590
 2x 4251969
 1x 6337195
 1x 6240515
 1x 6102597
 1x 4524098
 1x 6120224
 1x 4530129
 2x 6215341

 5x 6331687
 1x 6247359
 1x 4216581
 1x 6275030
 2x 6153863
 1x 6269973
 2x 6338135
 1x 4565394
 1x 4520638
 1x 4595889
 2x 6262952
 1x 4579690

 4x 6274747
 4x 6251306
 1x 6338955
 2x 362601
 4x 6258135
 4x 407001
 1x 6329595
 1x 6174310
 1x 434601
 1x 403201
 3x 6097801
 1x 6284507
 2x 6059185
 3x 243201

 1x 9551
 6x 6285777
 1x 306901
 1x 6329575
 4x 300401
 1x 6218823
 1x 6329697
 1x 6126046
 1x 302201
 4x 366001
 1x 243101
 2x 6061047
 1x 6023806

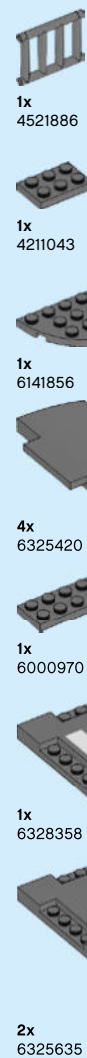
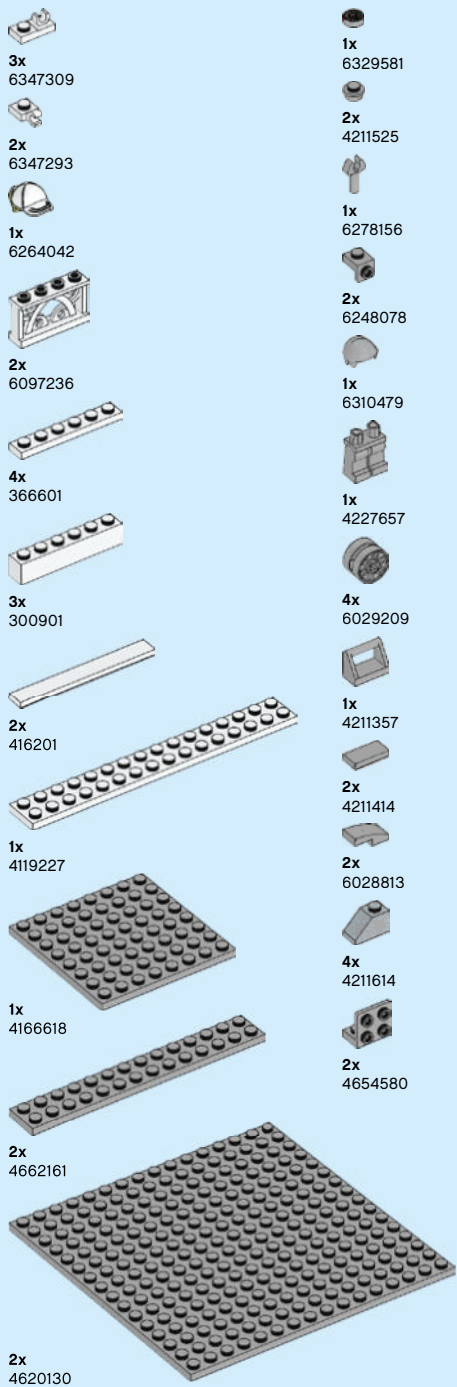

Customer Service
Kundenservice
Service Consommateurs
Servicio Al Consumidor
LEGO.com/service or dial

 : 00800 5346 5555
 : 1-800-422-5346

WIN

GO TO WWW.LEGO.COM/PRODUCTFEEDBACK AND
GIVE US YOUR SHORT **FEEDBACK** ABOUT THIS
LEGO® SET FOR A CHANCE TO WIN
A COOL LEGO PRIZE.

Terms & Conditions apply



LEGO.com/productfeedback

GEWINNE

Erzähle uns auf
www.LEGO.com/productfeedback

etwas über die Erfahrungen, die
du mit diesem LEGO® Set gemacht
hast, und sichere dir die Chance
auf einen coolen LEGO Preis!

Es gelten die
Teilnahmebedingungen

GAGNE

Rends-toi sur
www.LEGO.com/productfeedback

et donne-nous quelques com-
mentaires sur ce produit LEGO®
pour avoir une chance de gagner
un prix LEGO !

Voir Conditions Générales

GANANA

Visita
www.LEGO.com/productfeedback

y envíanos tu opinión acerca de
este set LEGO®. ¡Participarás en el
sorteo de un premio LEGO!

Términos y Condiciones aplicables

获取奖品

登录
www.LEGO.com/productfeedback

给出关于此乐高®套装的简短反馈，
就有机会获得炫酷乐高奖品

《条款及条件》适用

경품 당첨 기회

www.LEGO.com/productfeedback

페이지로 이동하여 이 레고® 세트에
대한 간단한 피드백을 보내 주시고
멋진 레고 경품을 탈 수 있는 기회도
잡으십시오

약관 적용

ЗАПОЛНИ АНКЕТУ И ПОЛУЧИ ПРИЗ

Перейди по ссылке
www.LEGO.com/productfeedback

ответь всего на несколько во-
просов об этом наборе LEGO®,
и у тебя появится шанс выиграть
замечательный приз от компании
LEGO.

Применяются Условия и правила
участия



CITY

60306



3

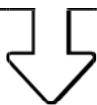
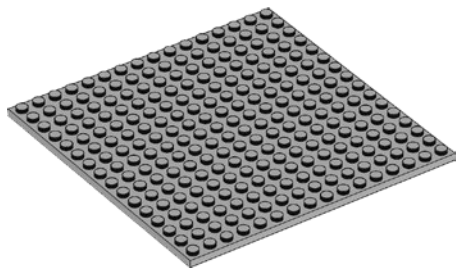

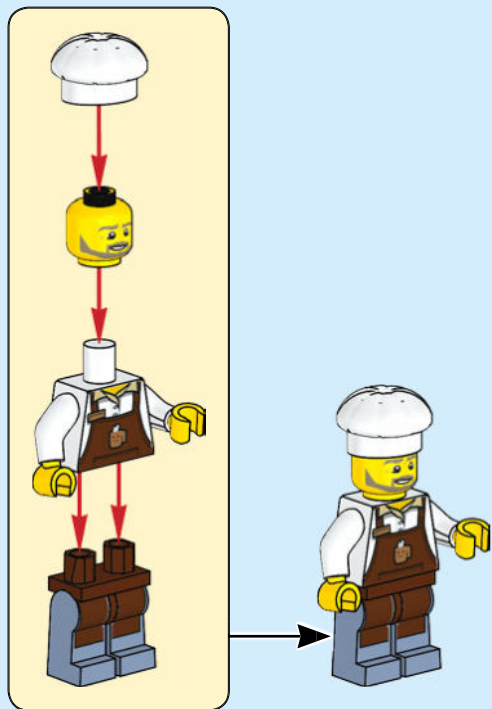



2x

1

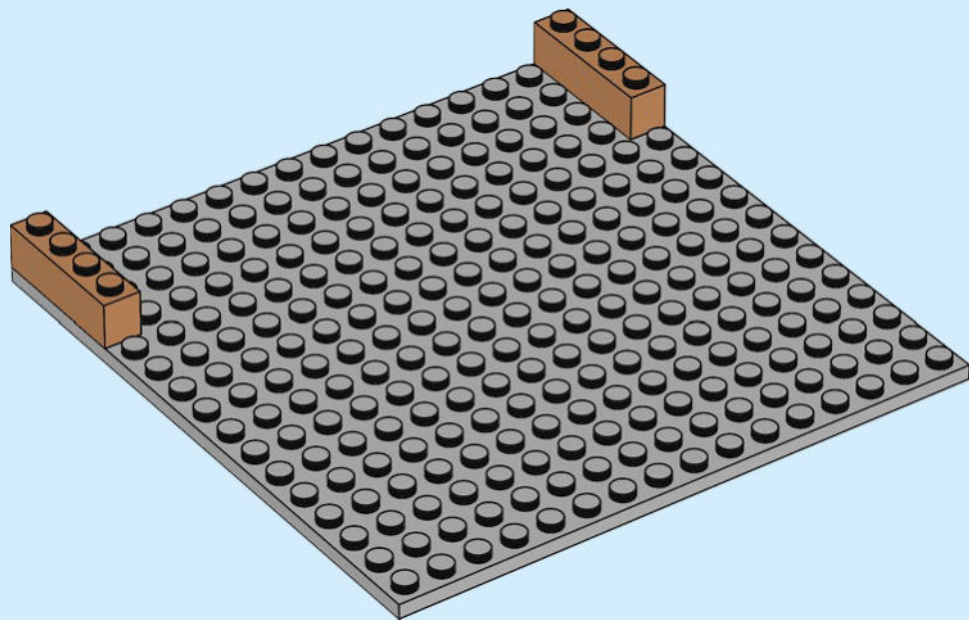

4

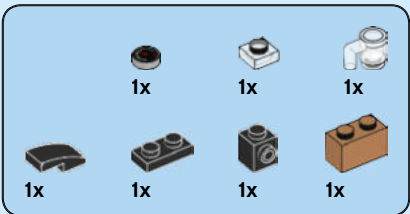

2

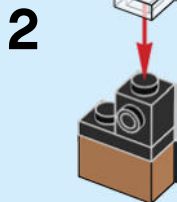
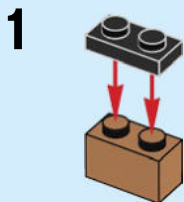

4



5



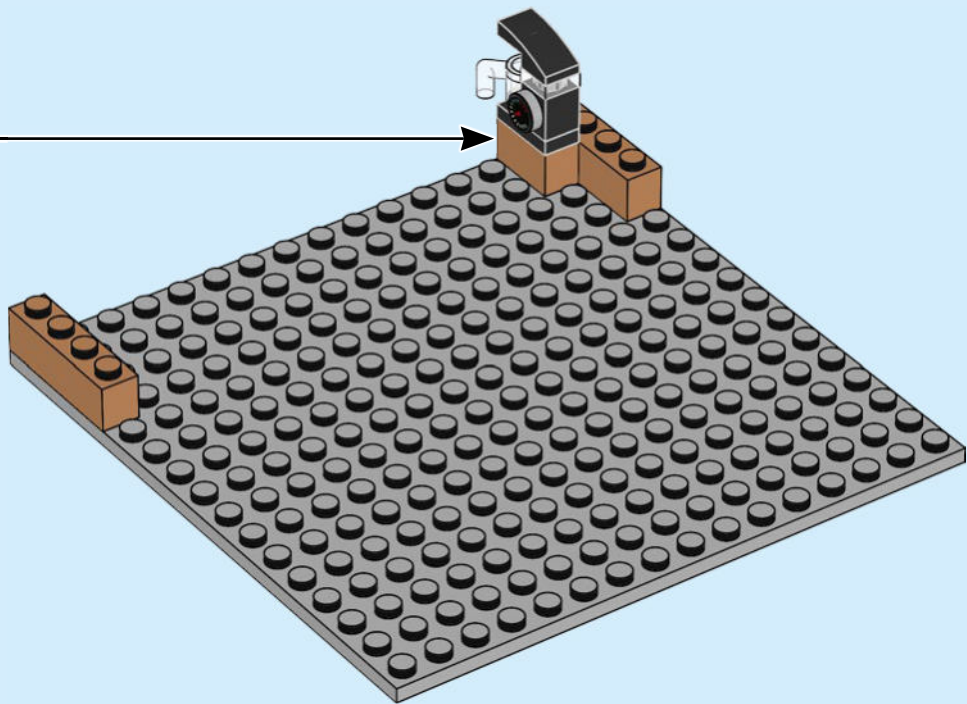

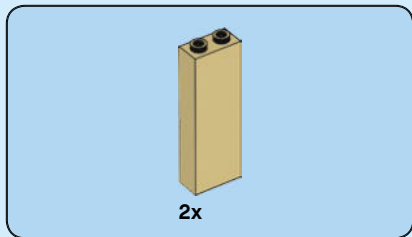

3

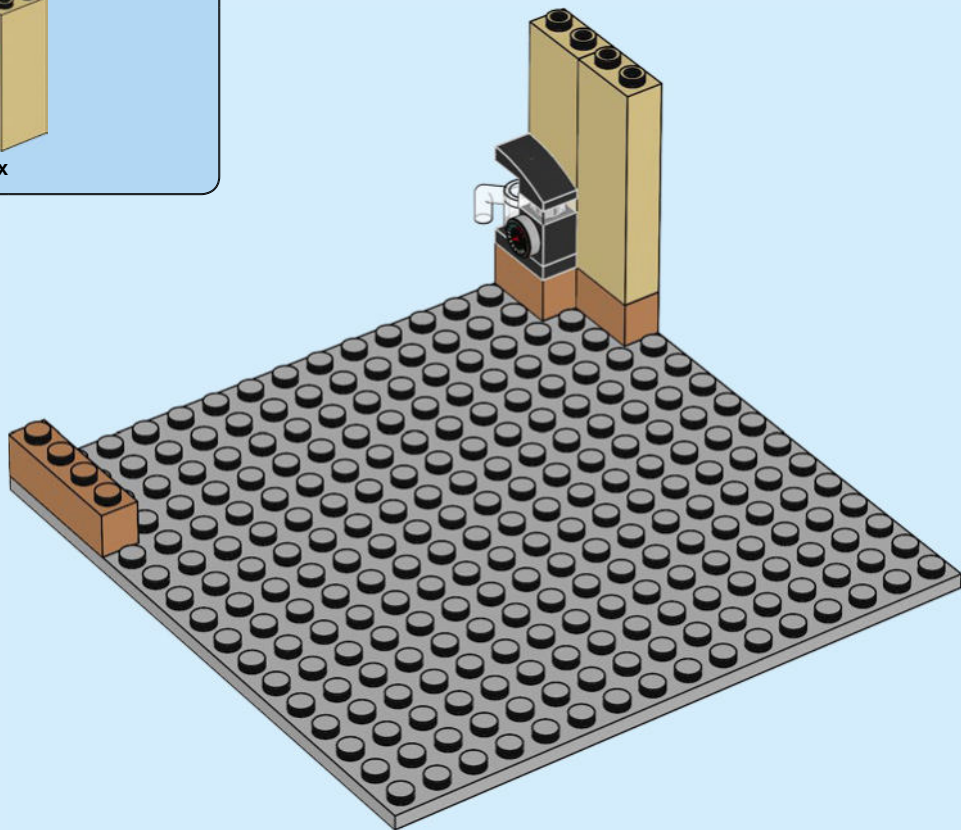

8

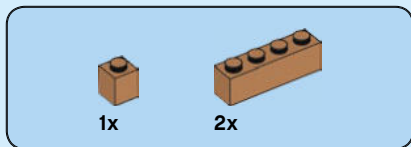

4

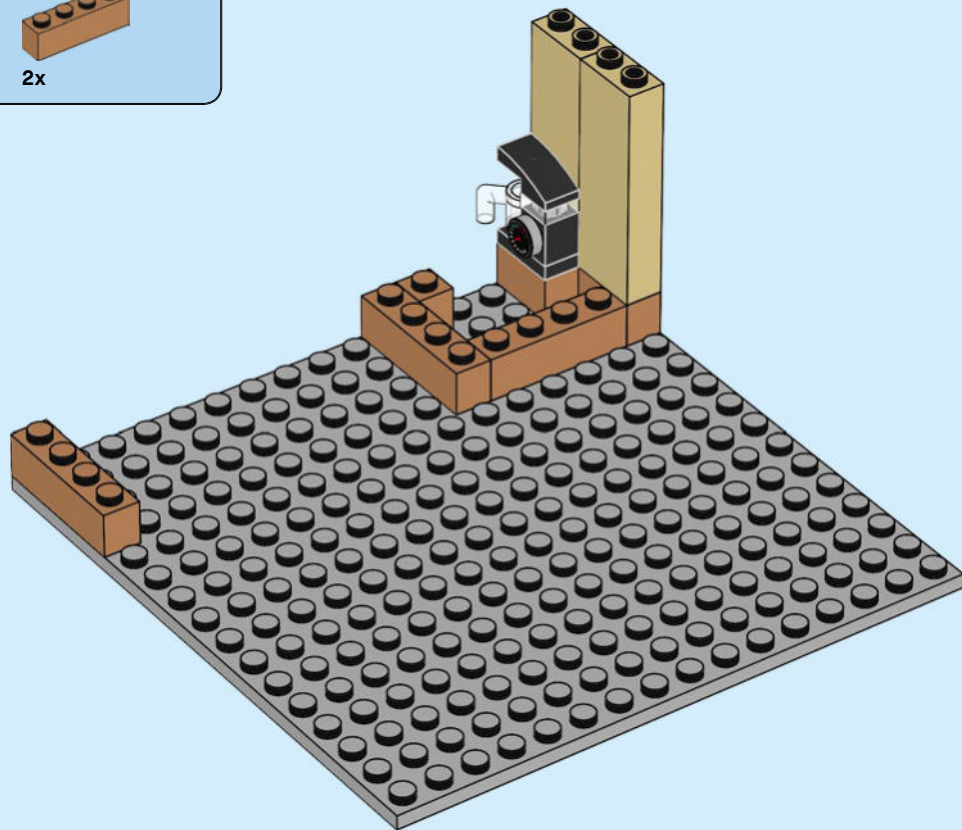



1x



2x

5

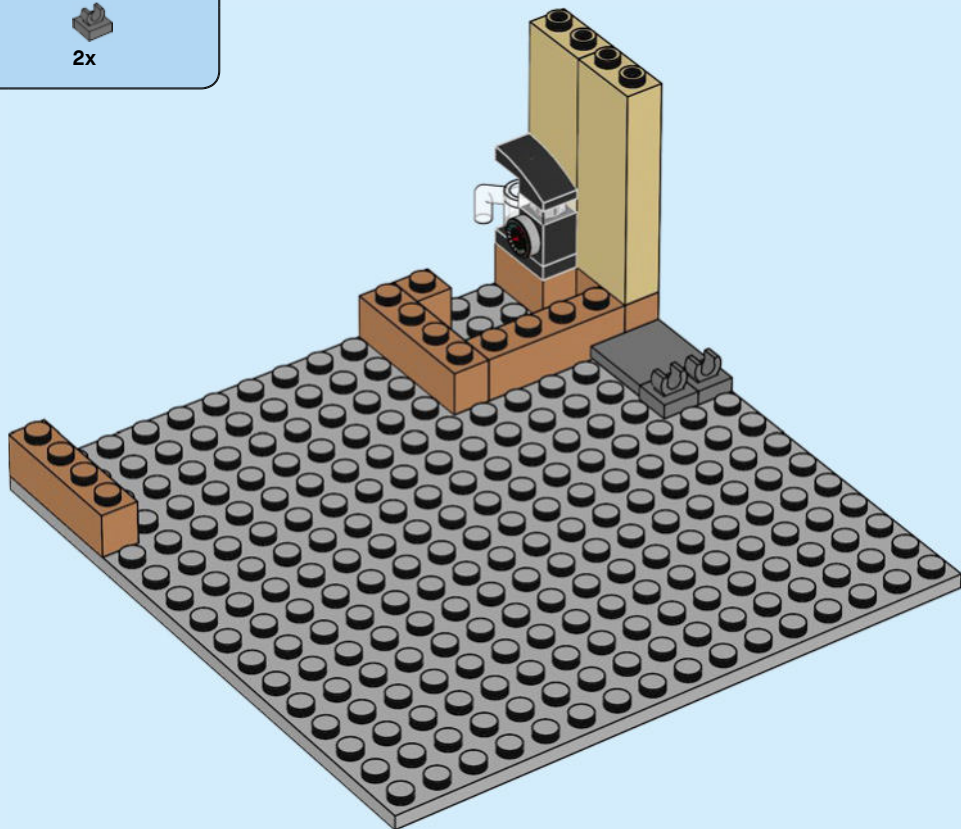

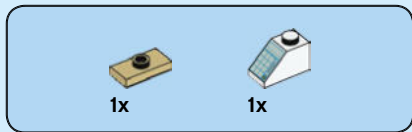

6

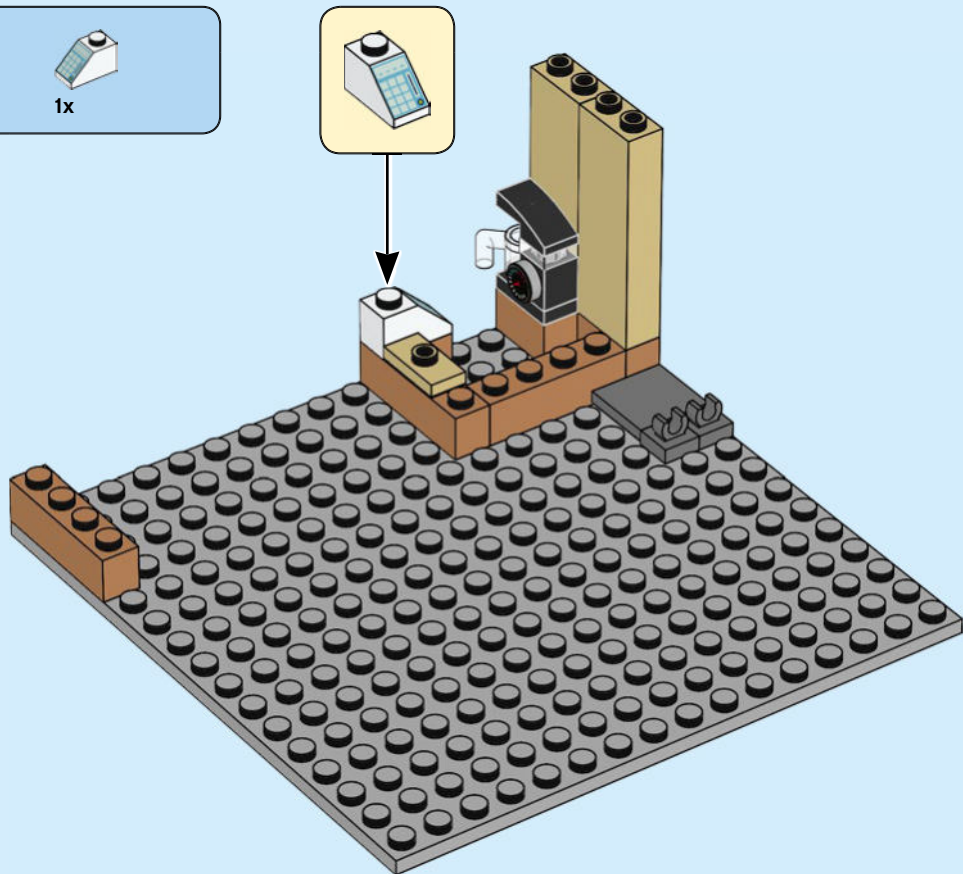



2x

7

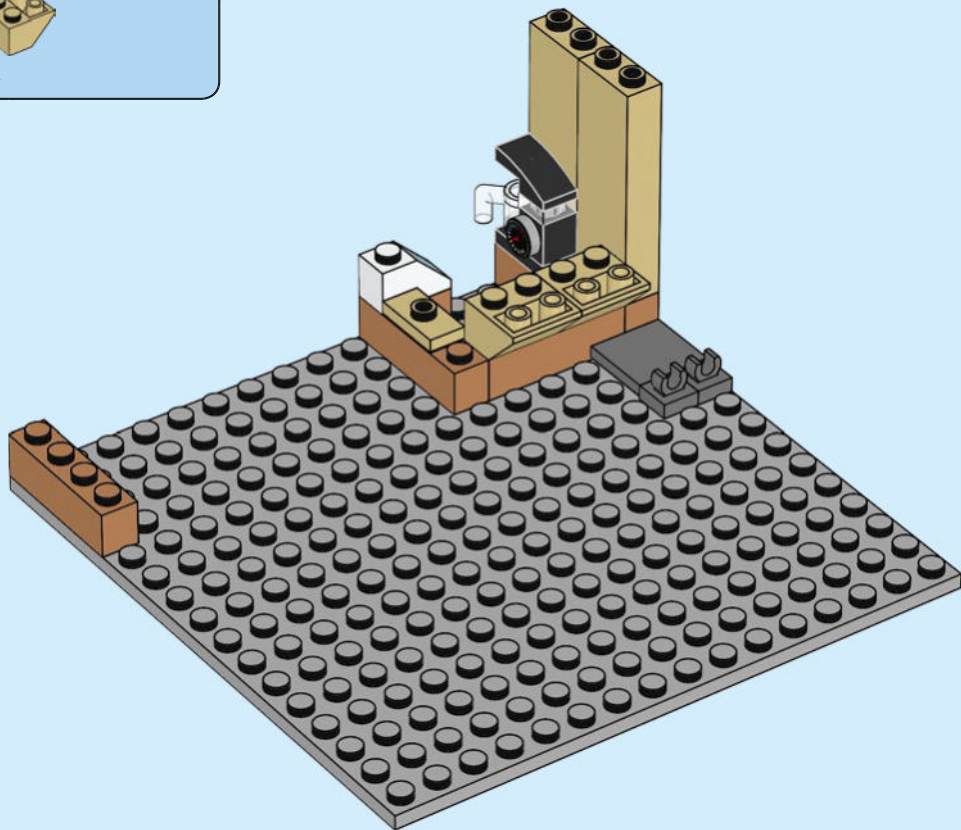

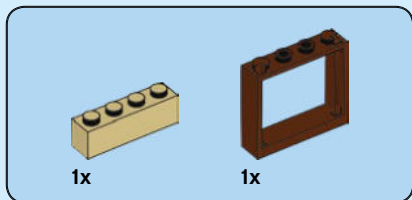

8

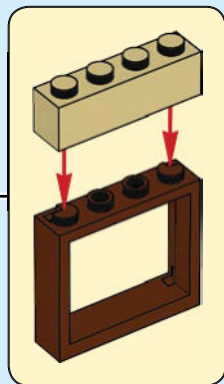
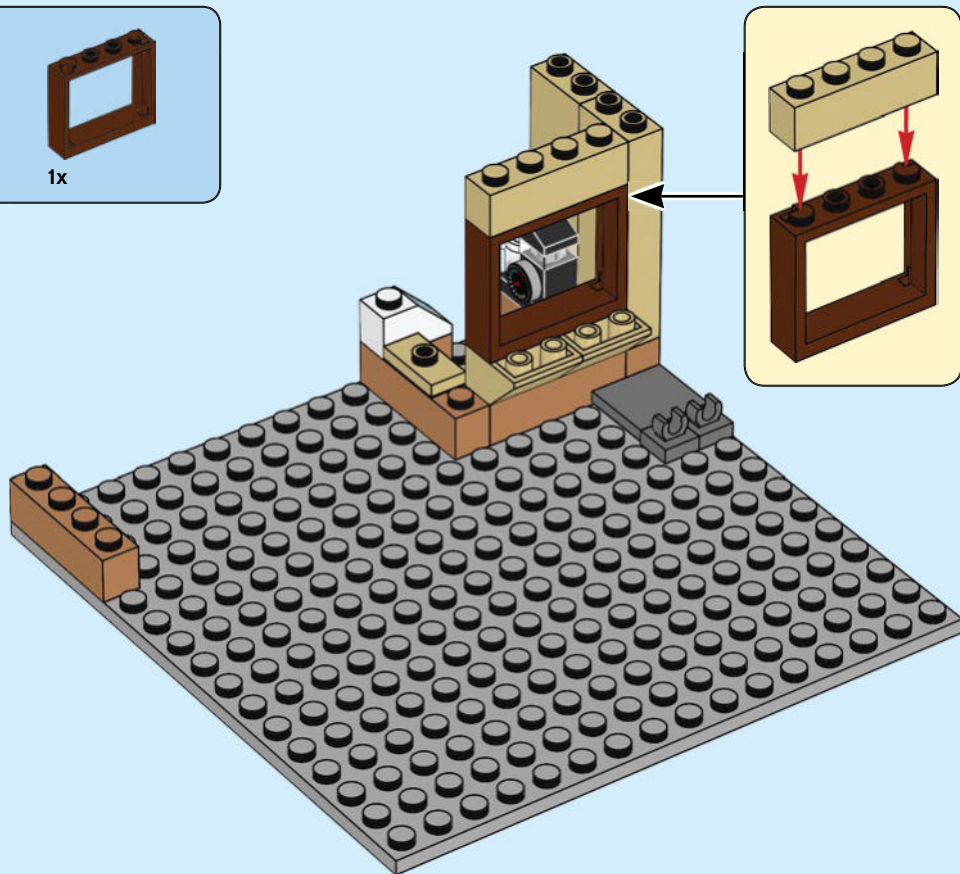

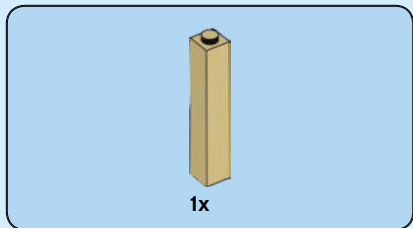

9

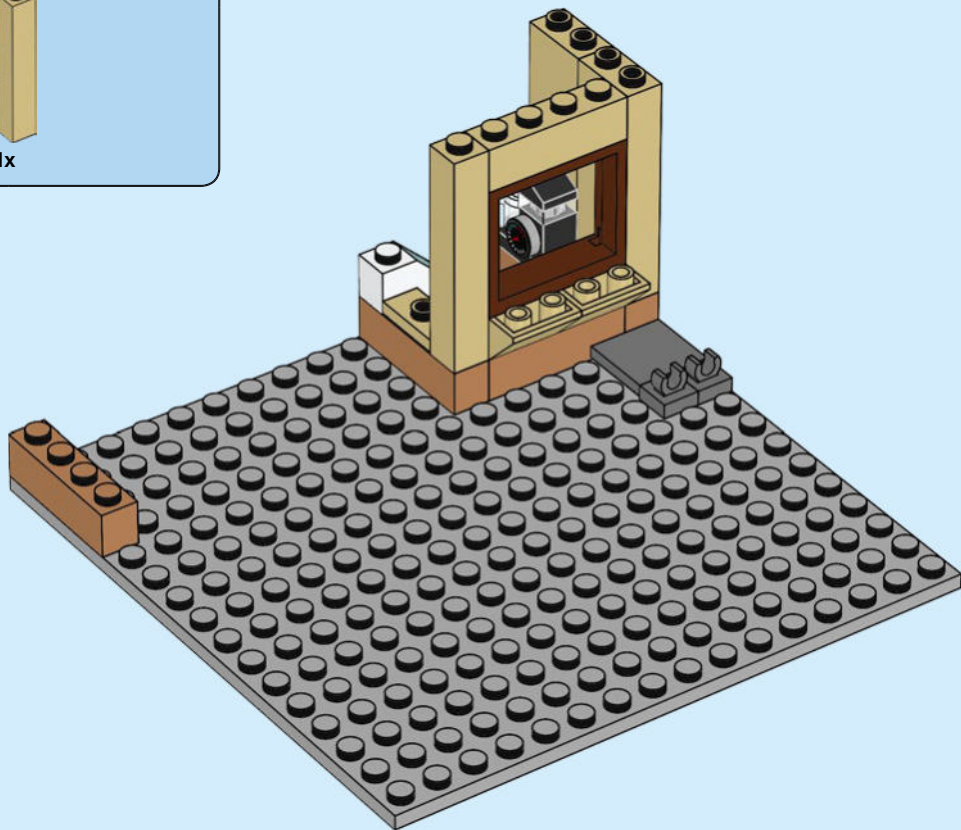



10

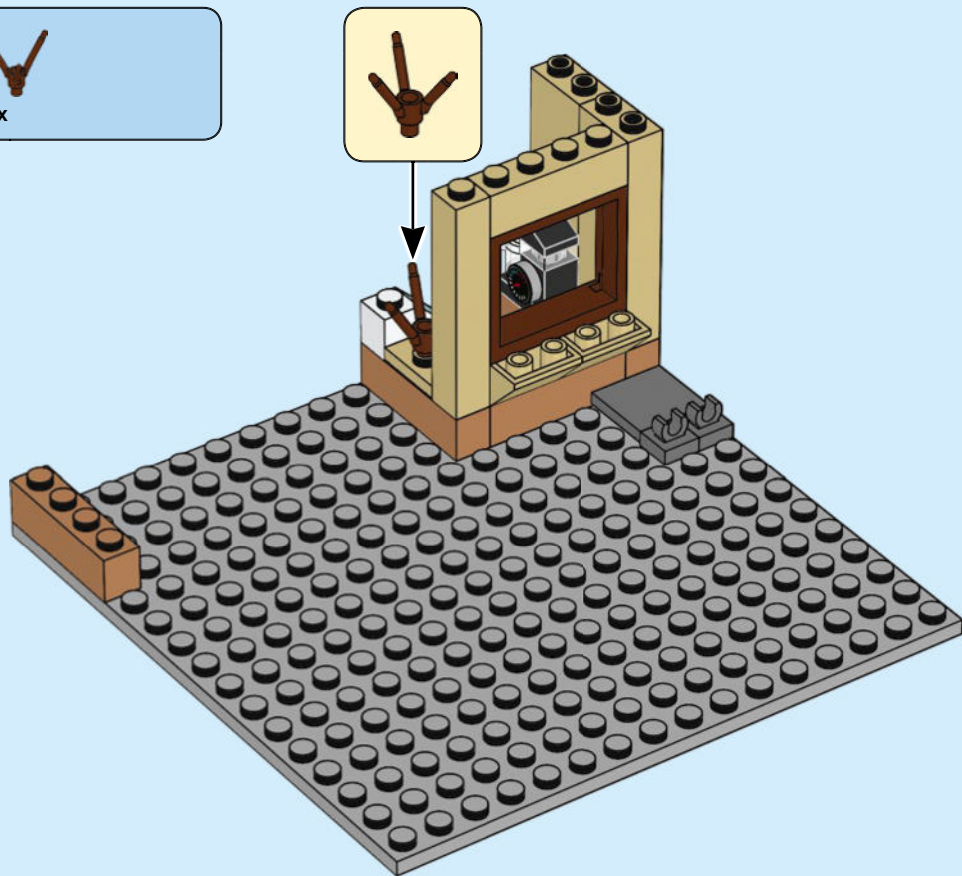

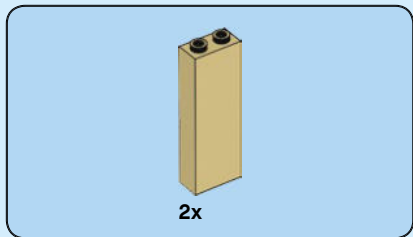

11

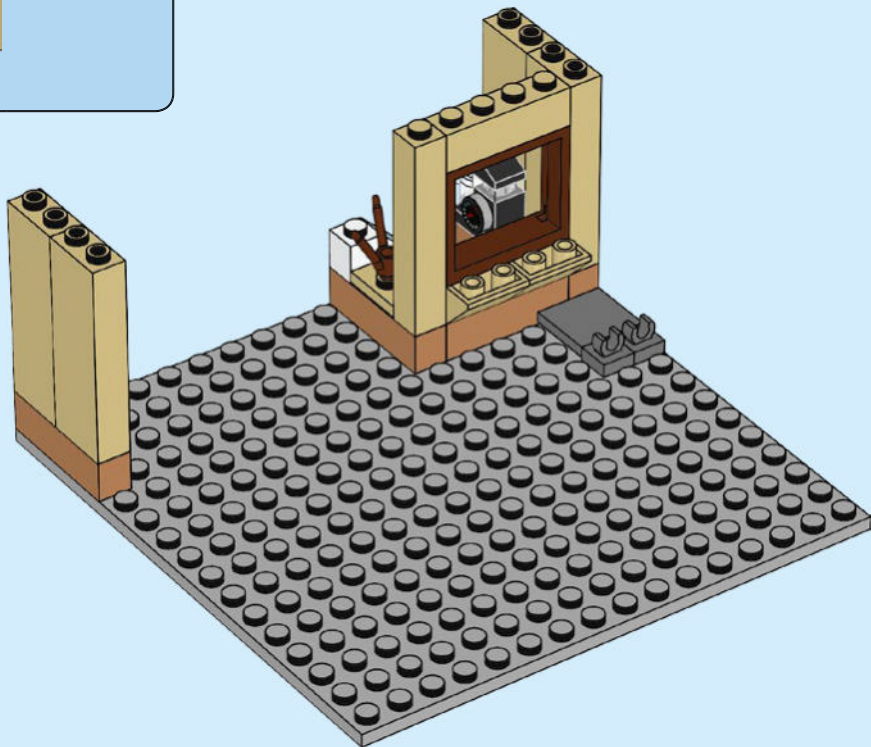

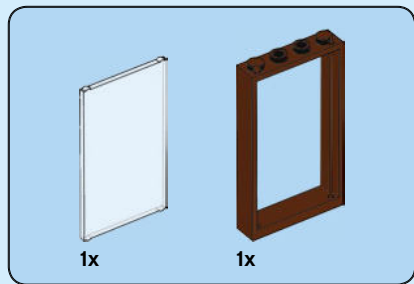

12

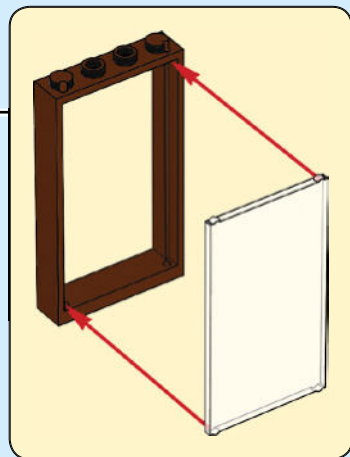
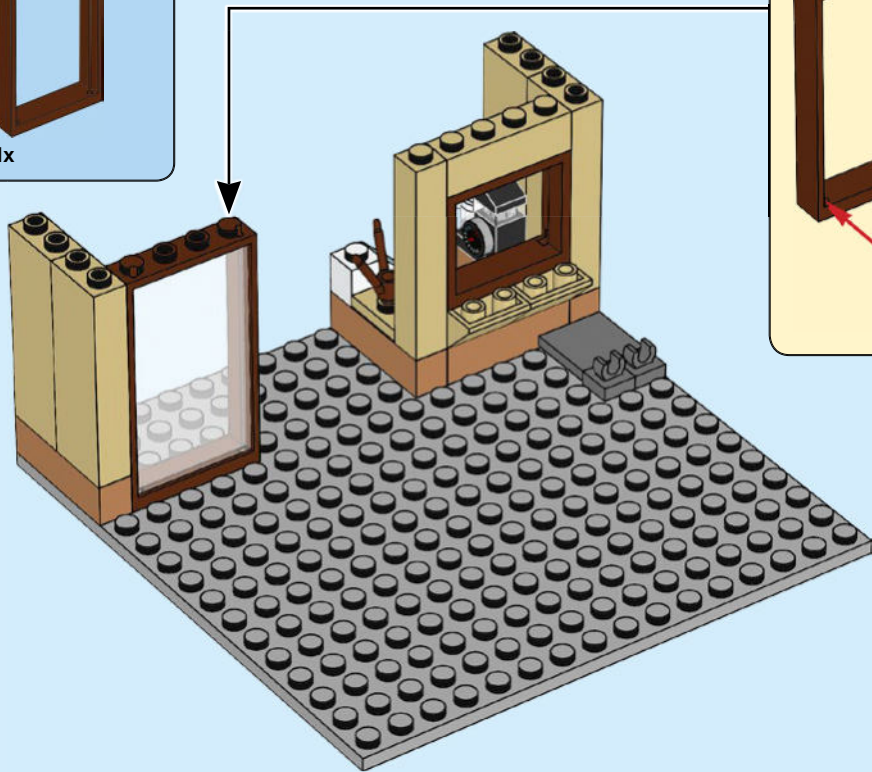

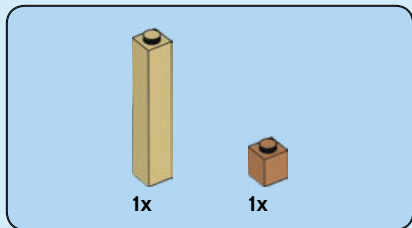

13

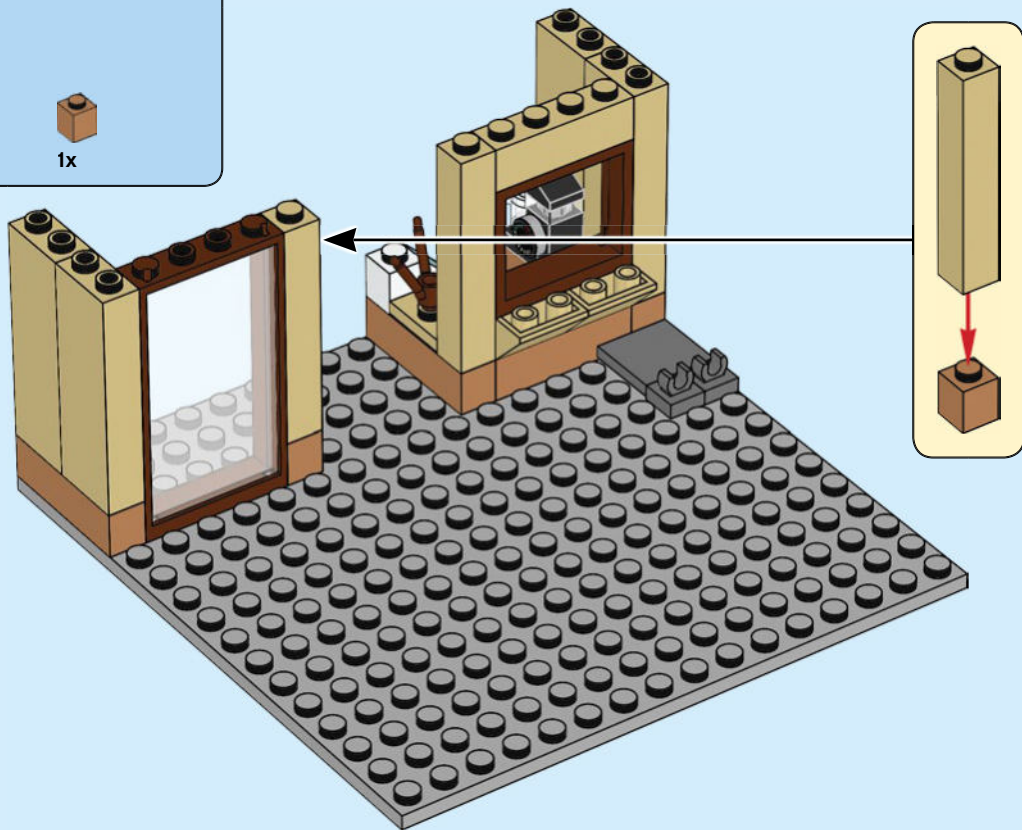

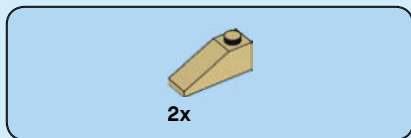

14

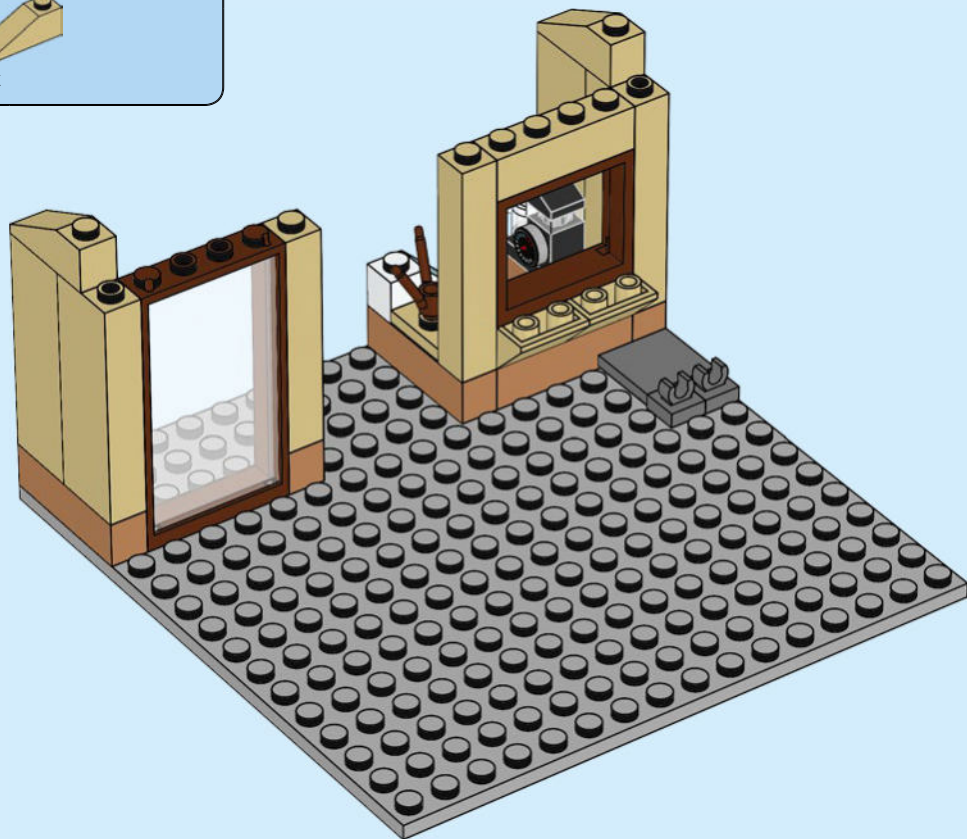

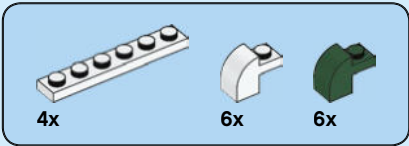
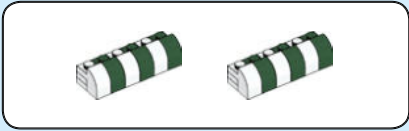

15

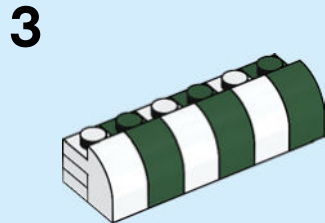
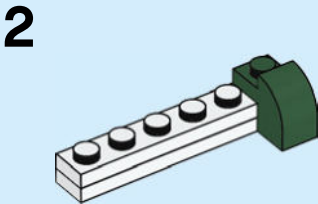
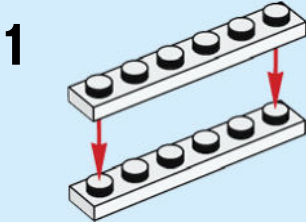

2x

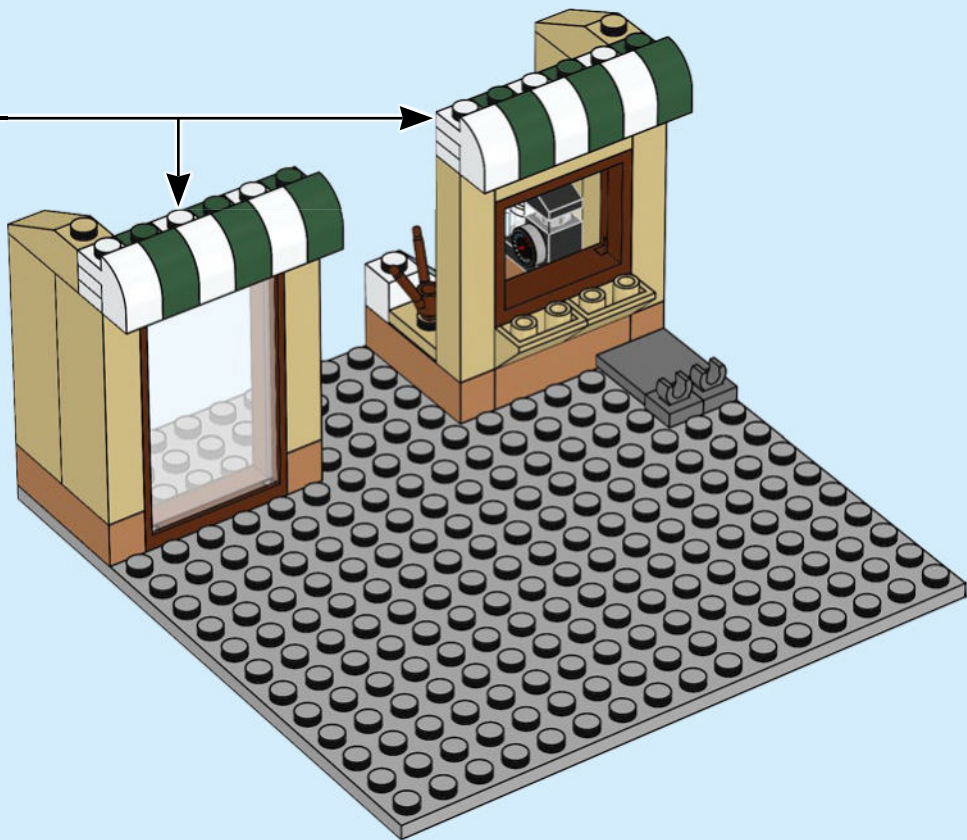

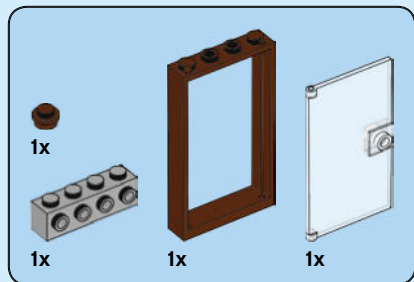

16

1

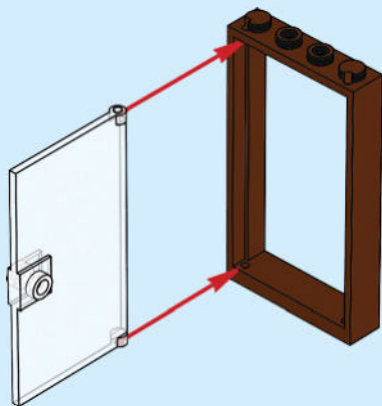

2



3

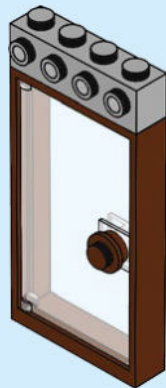

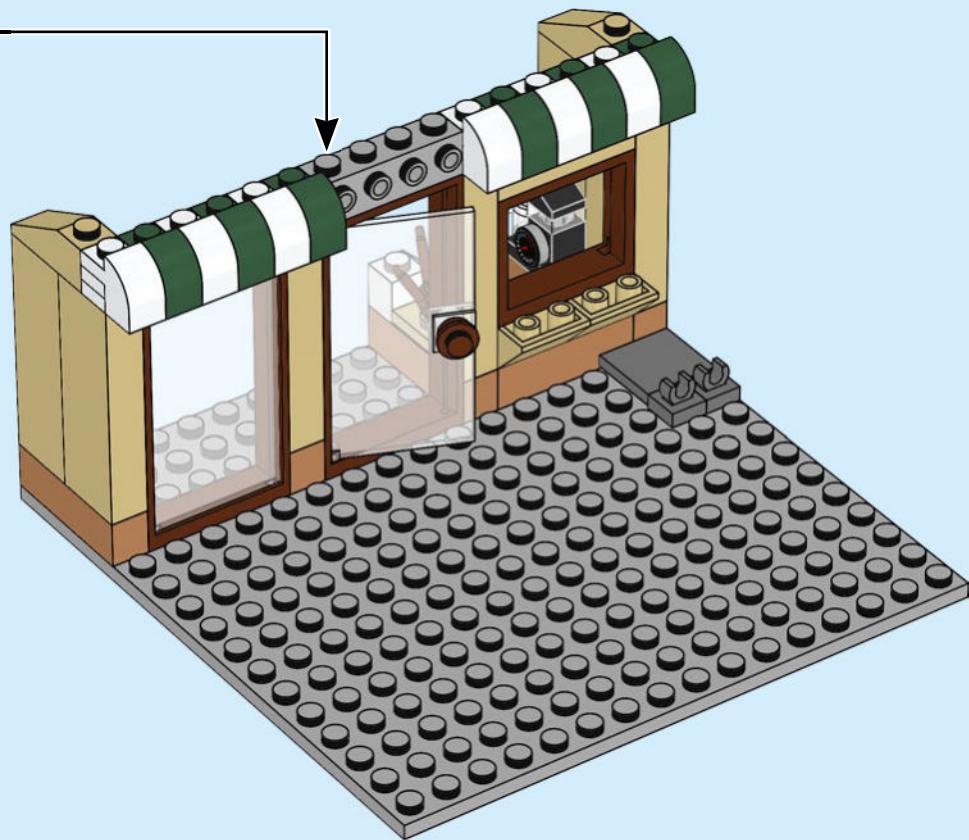

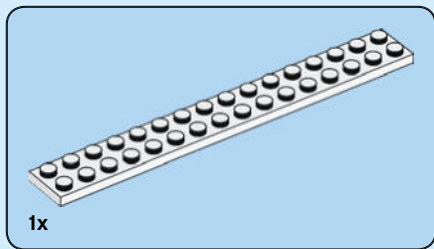

17



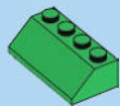

3x

18



26



19



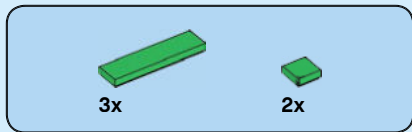

20



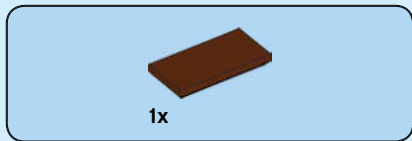

21

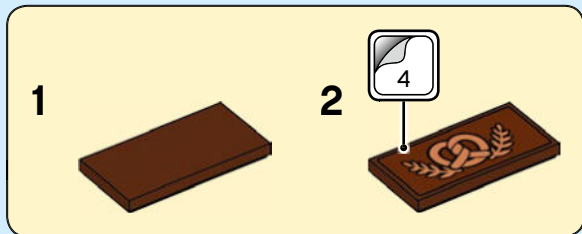

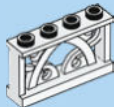

2x

22



30

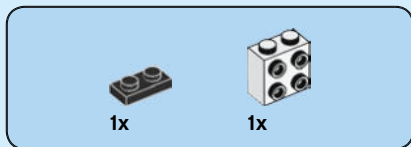

23

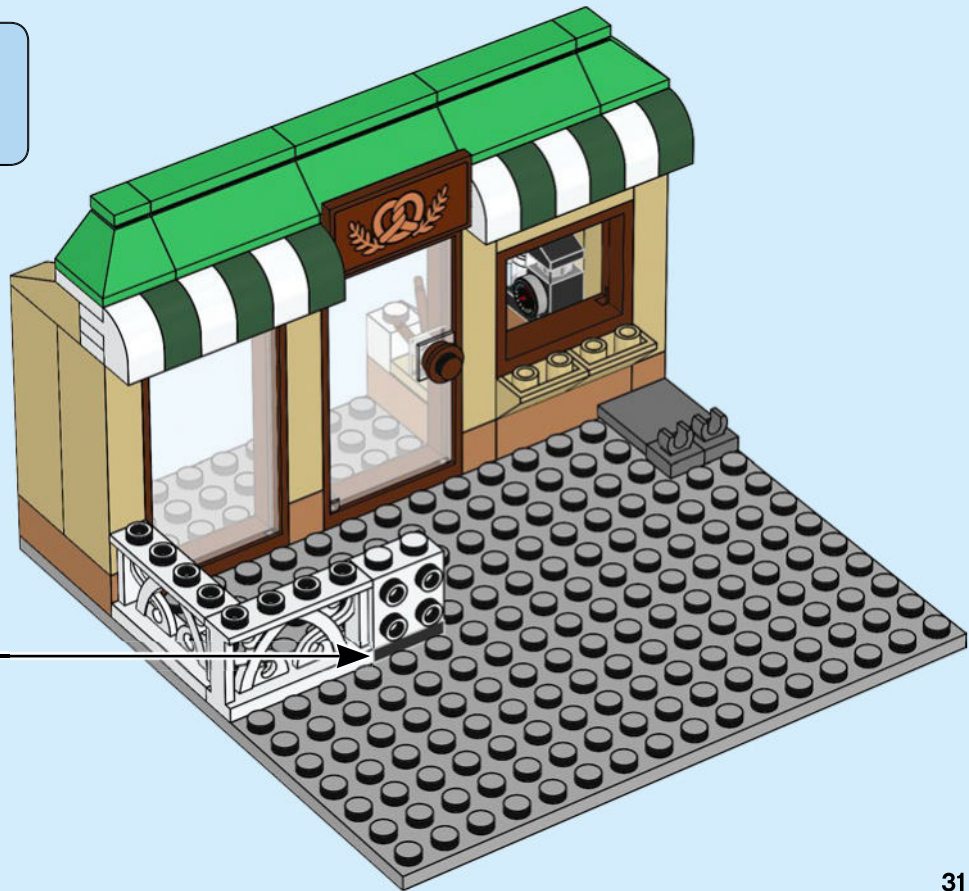
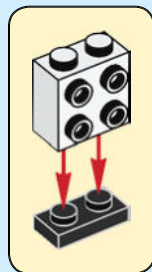



2x



2x

24





1x

25

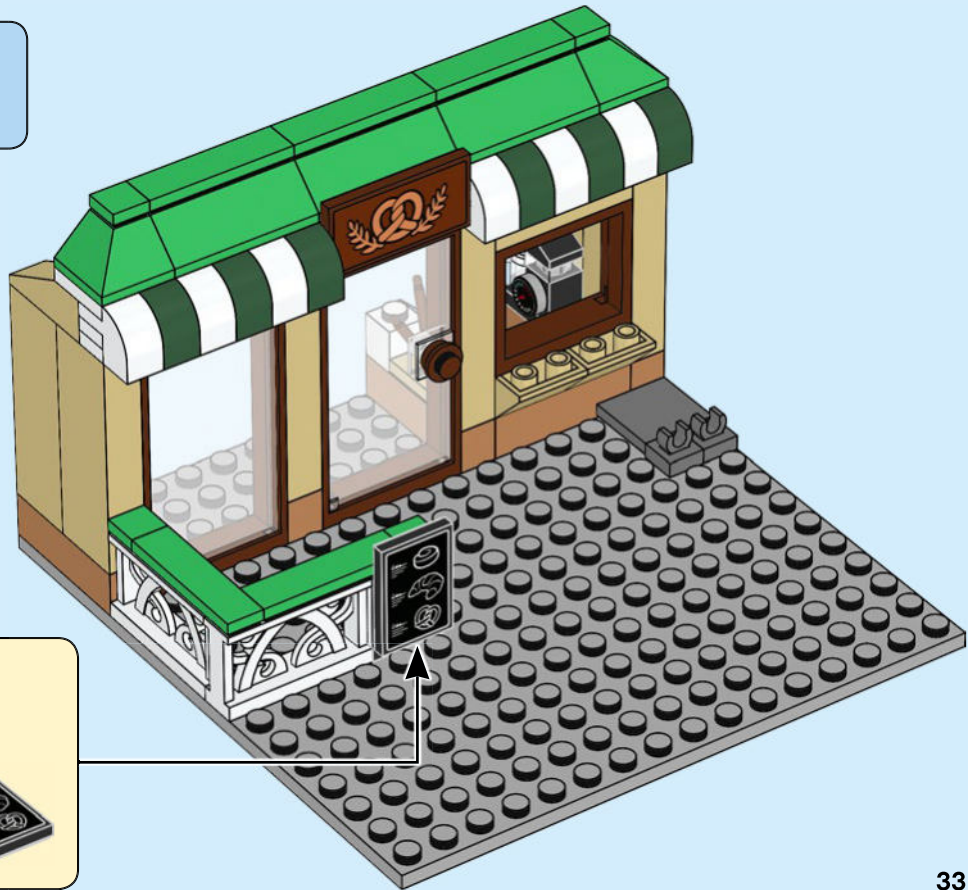

1



2





2x

26

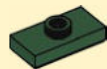

2x



2x



1x

27

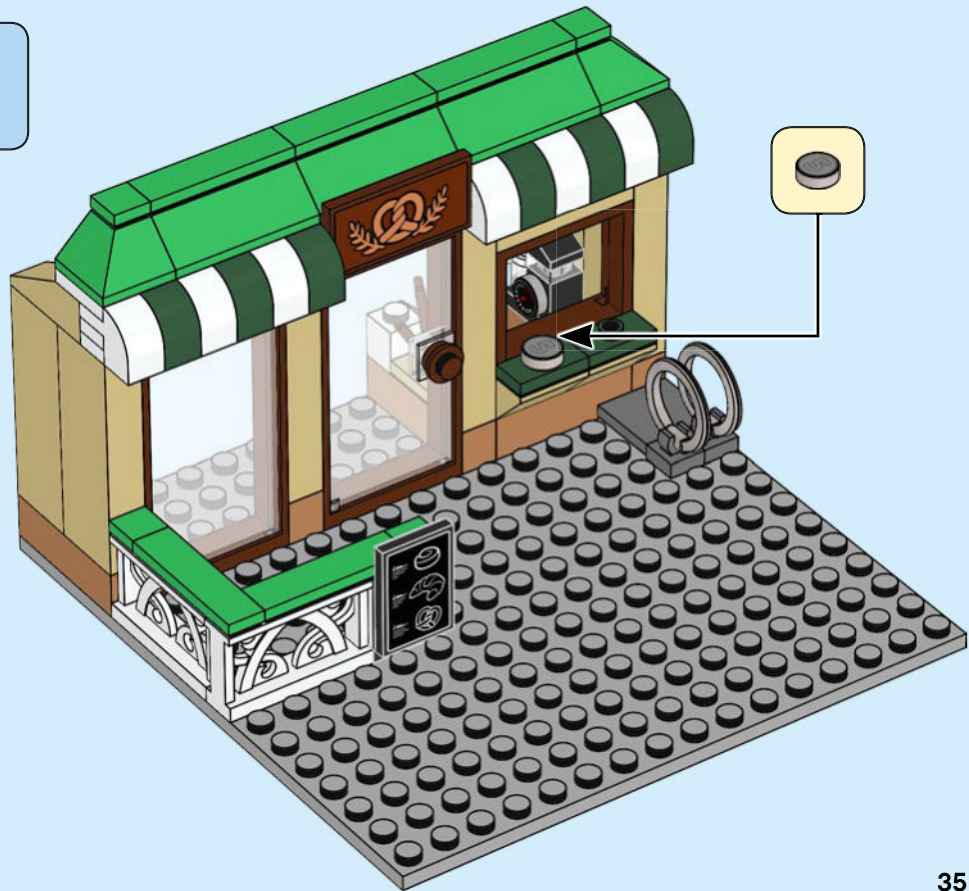



28

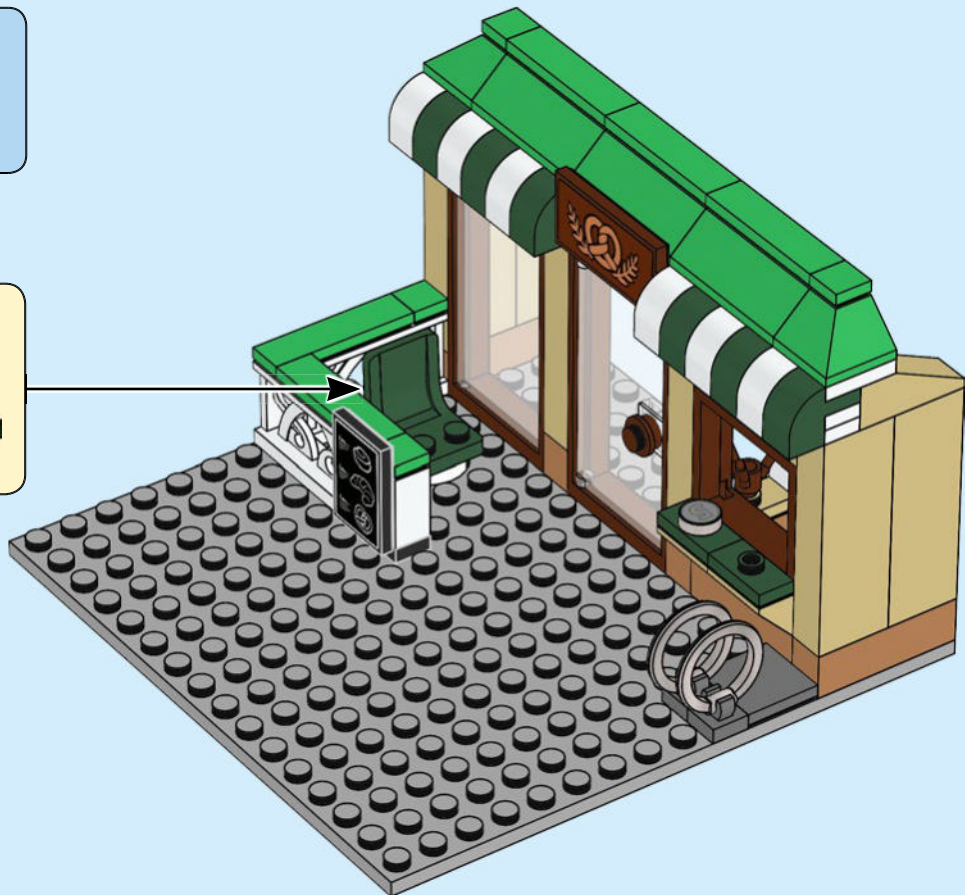

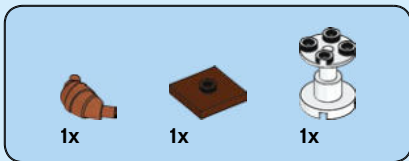

29

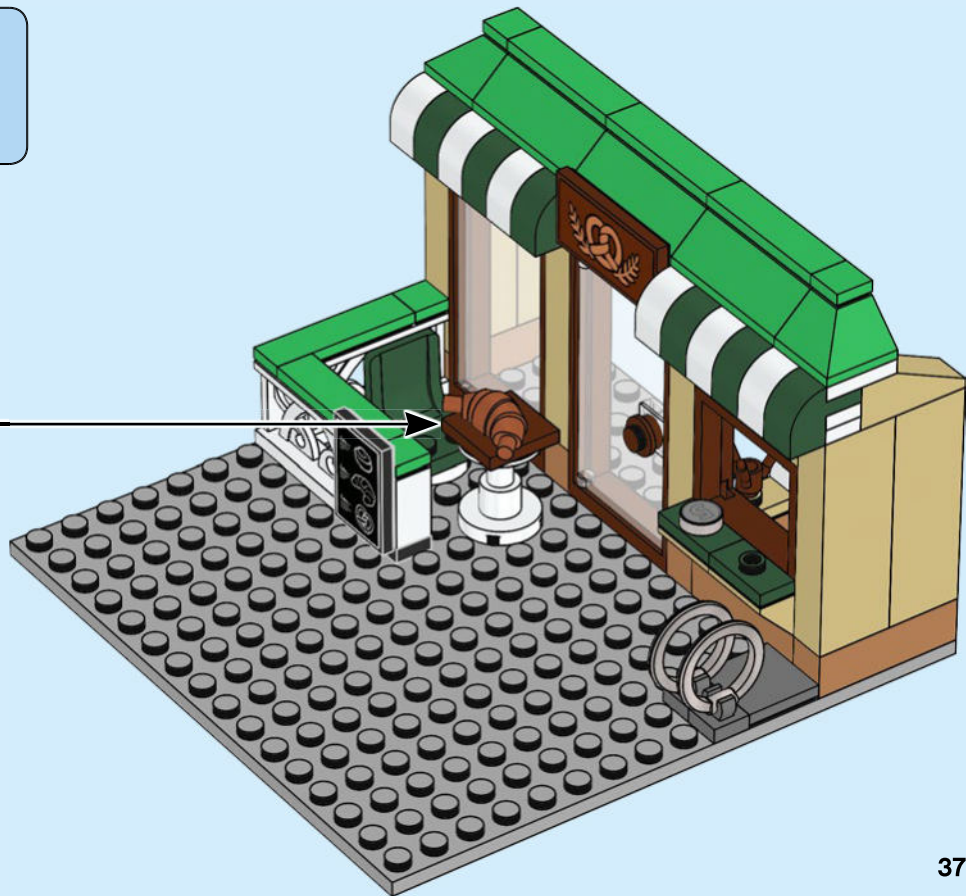
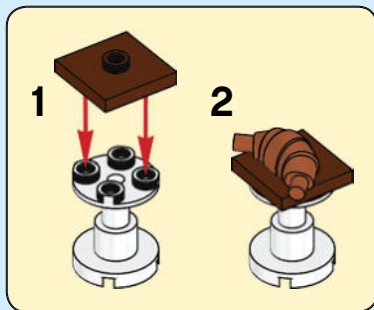

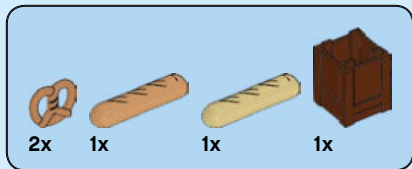

30

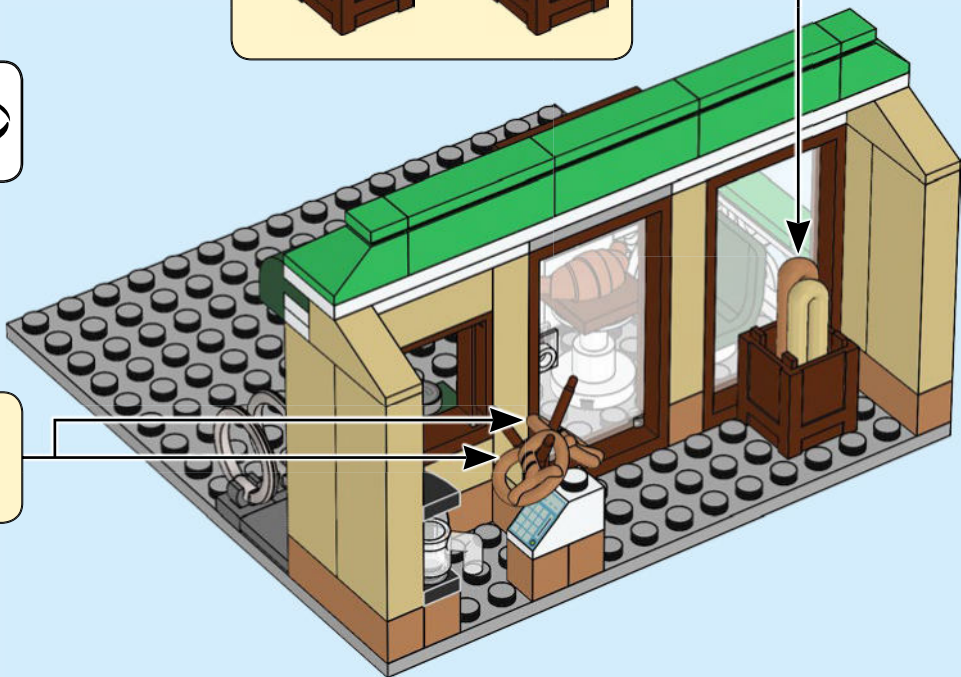
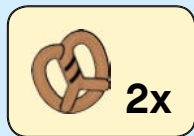
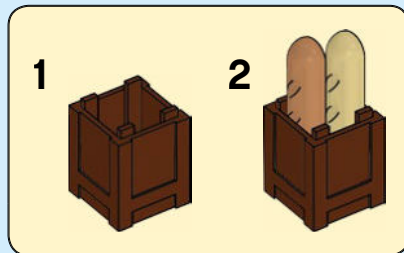

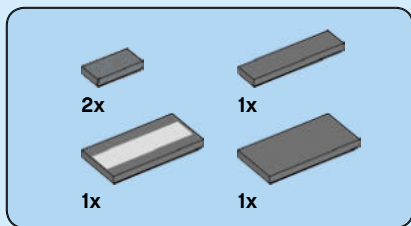

31

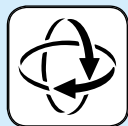

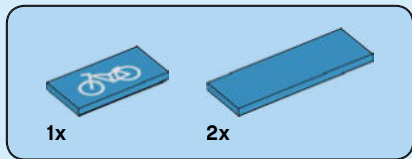

32

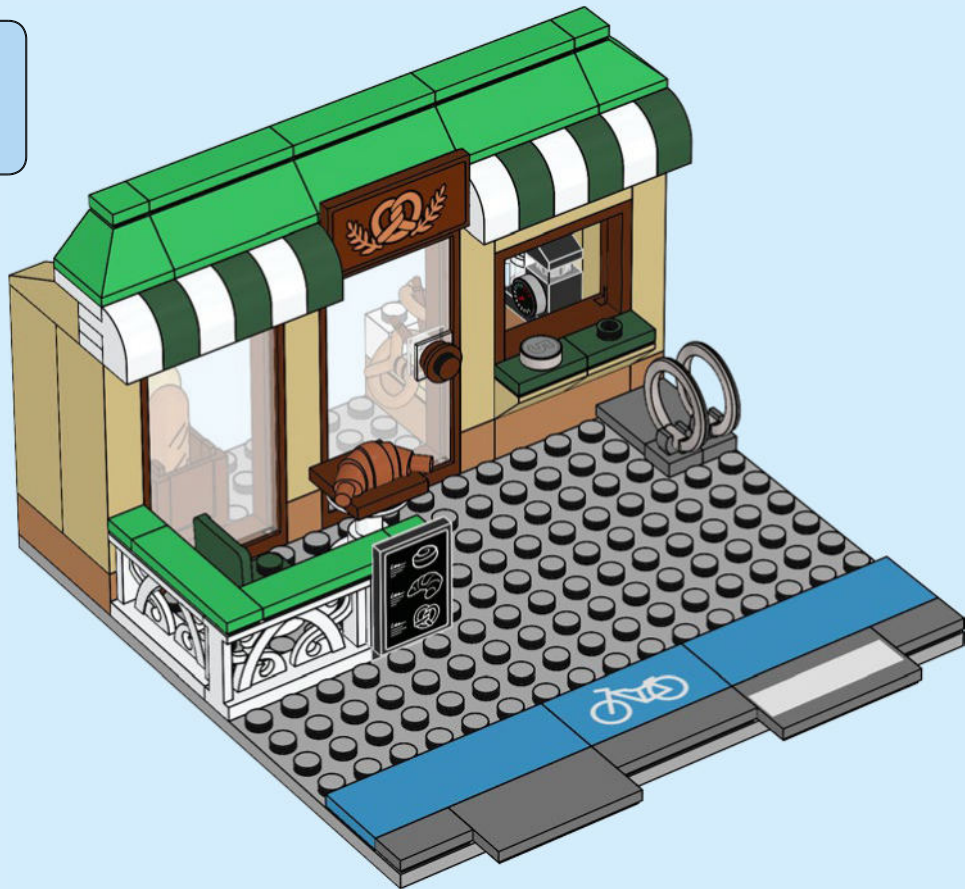

33

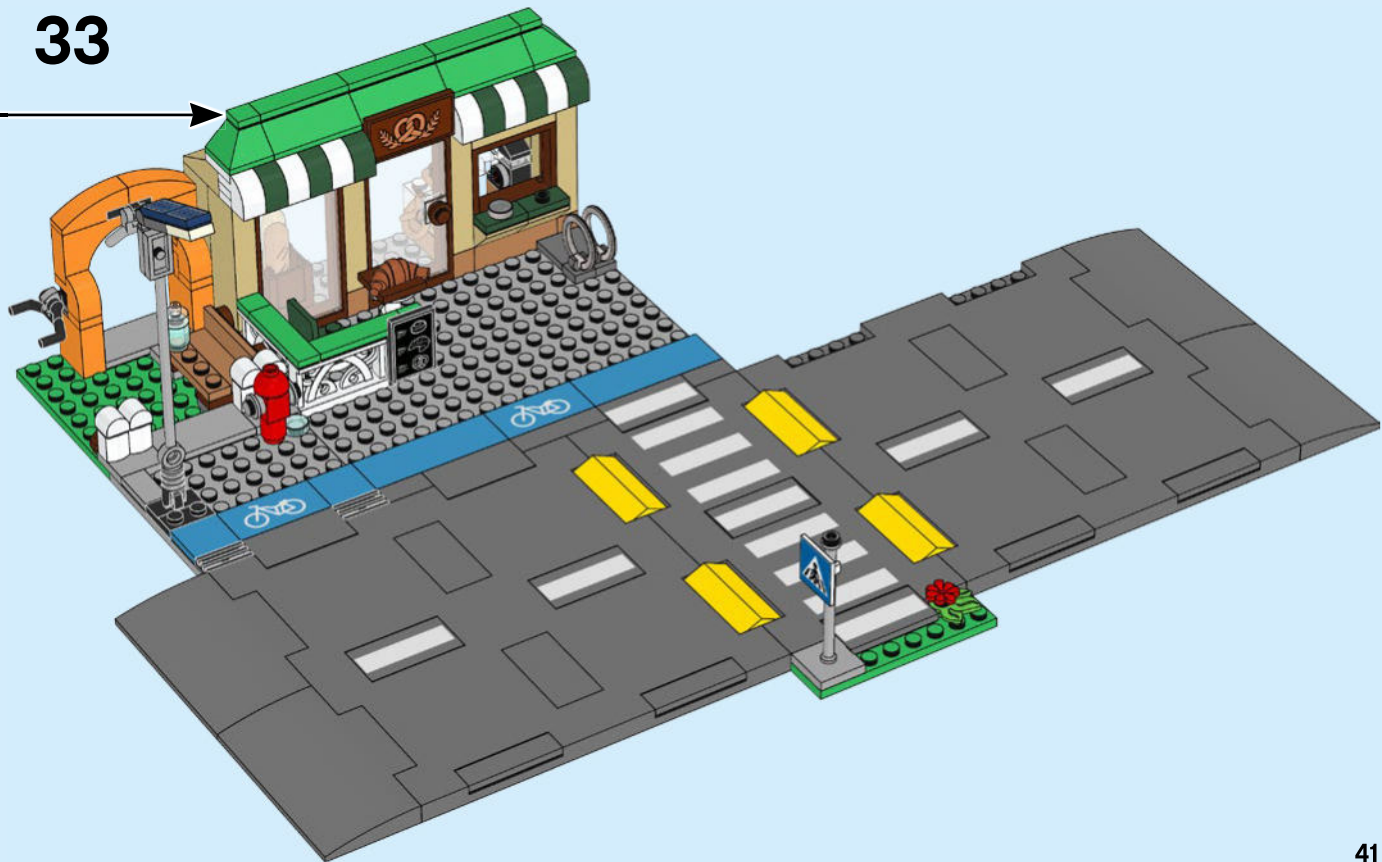

CITY ADVENTURES

City Abenteuer
Aventuras en City
City Aventuras
City kalandok
City piedzivojumi
乐高城市大冒险



VITO

60242



SAM
GRIZZLED

60243



SNAKE
RATTLER

60243 • 60276



ROOKY
PARTNER

60244



FRANKIE
LUPELLI

60244 • 60277



TOM
BENNETT

60245



BIG
BETTY

60245



WHEELER

60246



DAISY
KABOOM

60246



CLARA
THE CRIMINAL

60276



GRACIE
GOODHART

60277



DUKE
DETAIN

60242 • 60246 • 60276



FREYA
MCLOUD

60248 • 60280



CLEMMONS

60247 • 60281



BOB

60282



FELDMAN

60282



TREAD
OCTANE

60258



HARL
HUBBS

60258 • 60266



SHIRLEY
KEEPER

60292



MADISON

60292

CITY

ADVENTURES

City Abenteuer
Aventuras en City
City Aventuras
City kalandok
City piedzīvojumi
乐高城市大冒险

Aus der erfolgreichen TV-Serie!
Vu dans la série télévisée à succès !
Dalla divertentissima serie TV!
¡De la popular serie de la tele!
Da série de sucesso da TV!
A népszerű TV-sorozatból!
No populārā TV seriāla!
源自热门动画片!



FROM THE HIT
TV SERIES!



CITY



LEGO

CITY

60306



4

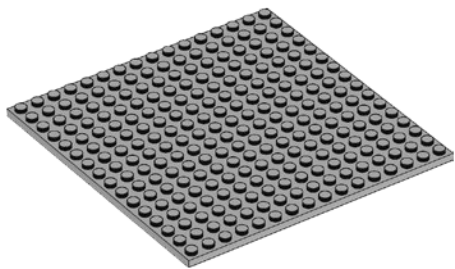

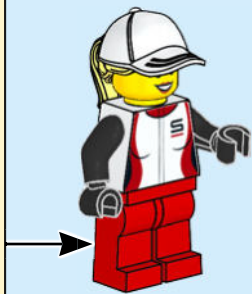

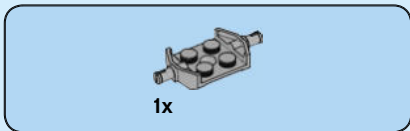
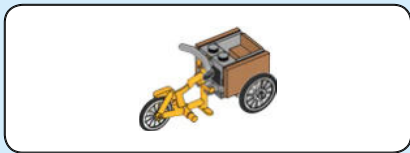

1x

1

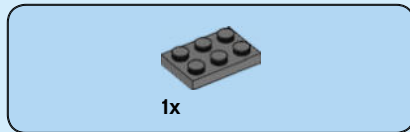

1x

2





2x

3

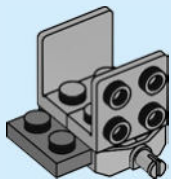

6



1x

4

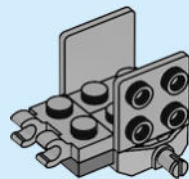

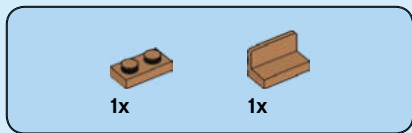

5

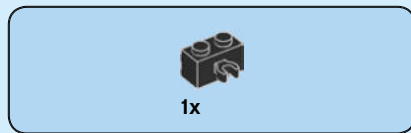
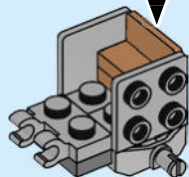
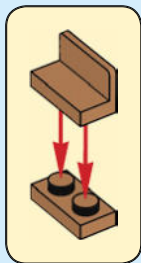

6

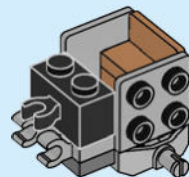



2x

7

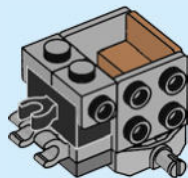

8



2x

8

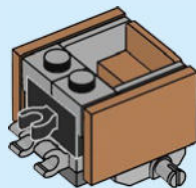

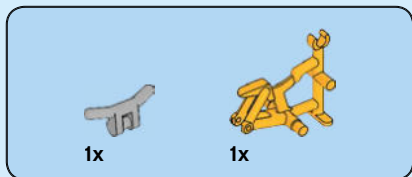

9

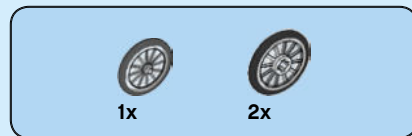
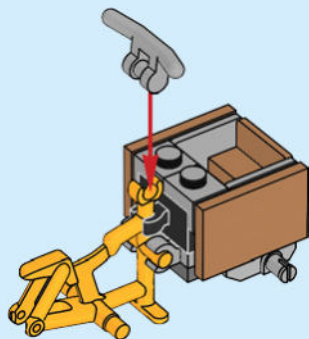

10

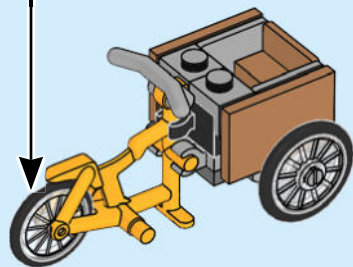
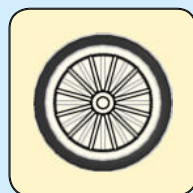



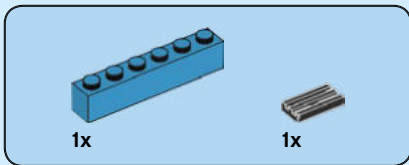

1

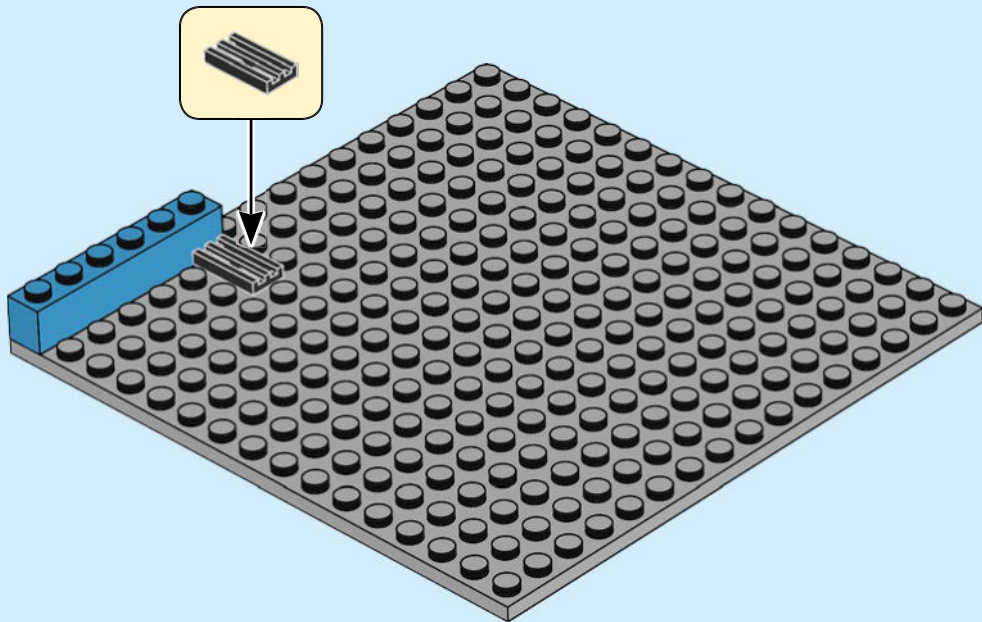



2x

2

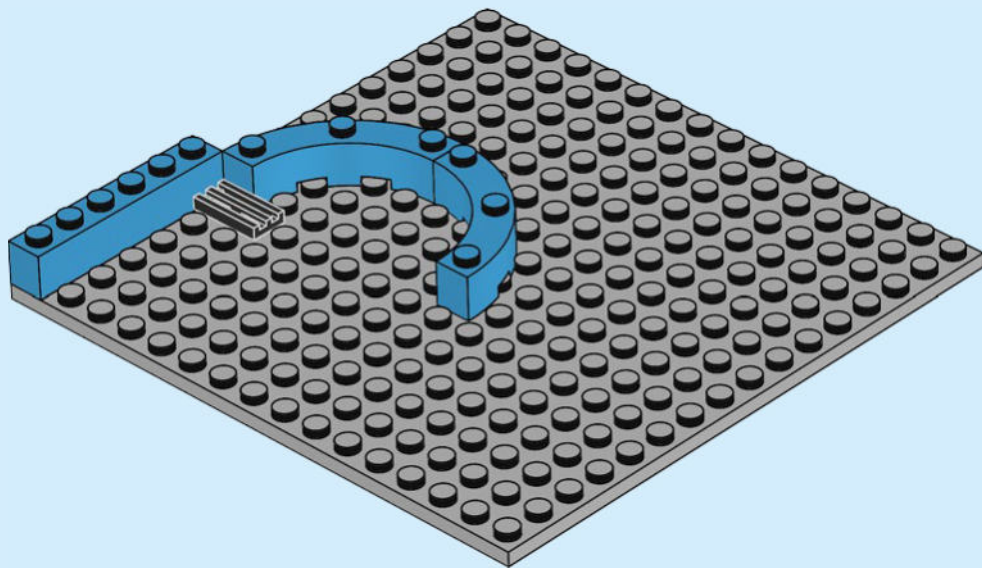



1x

3

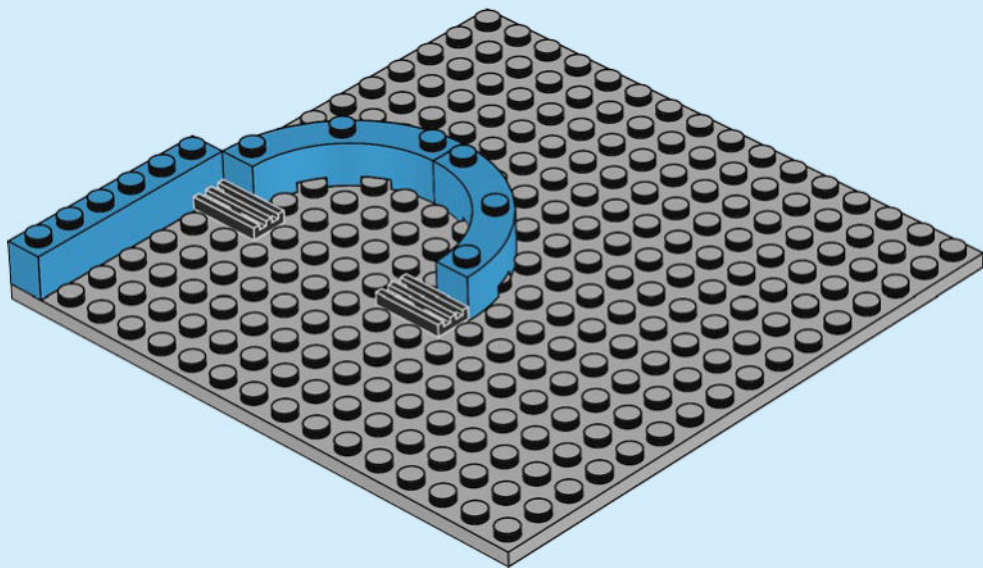

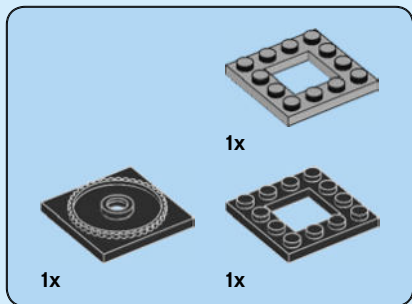

4

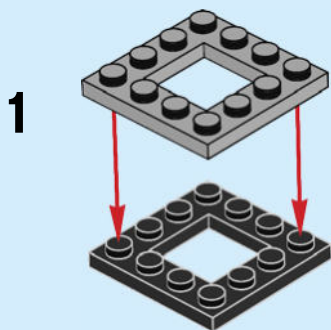

2

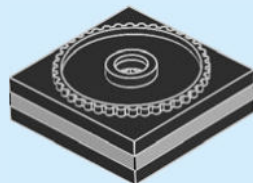

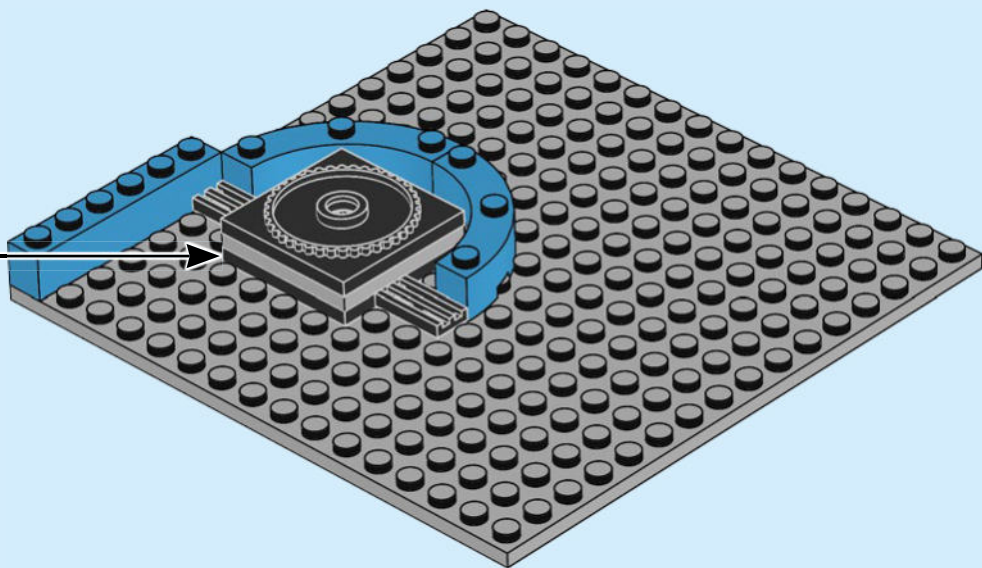

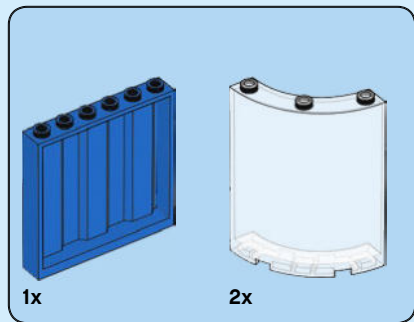

5

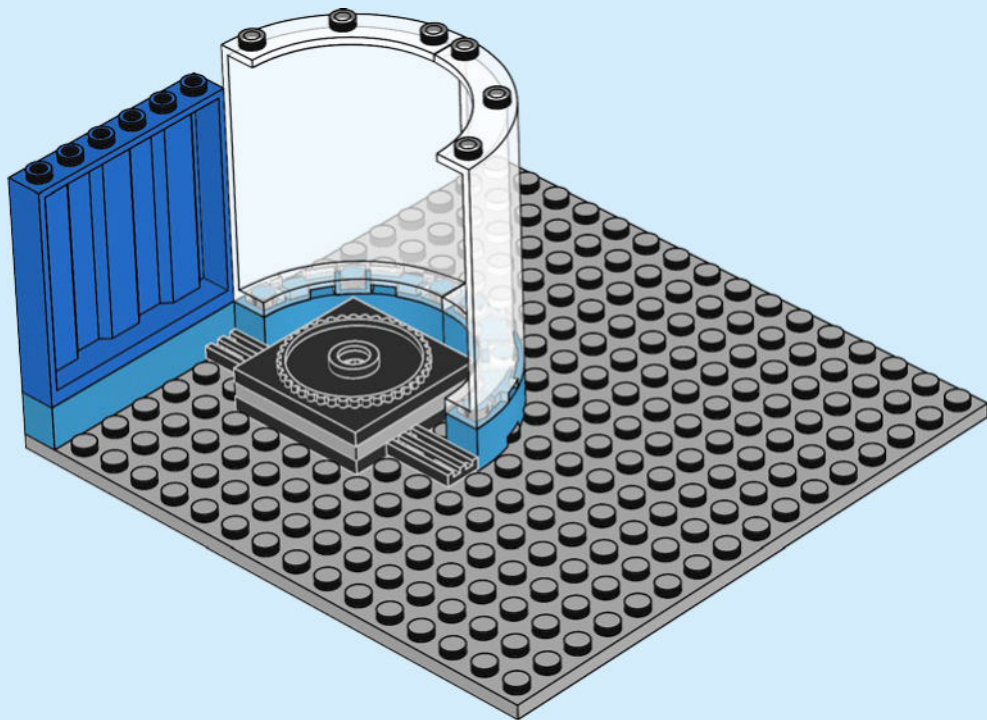

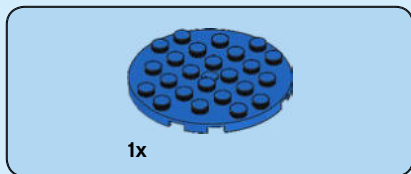

6

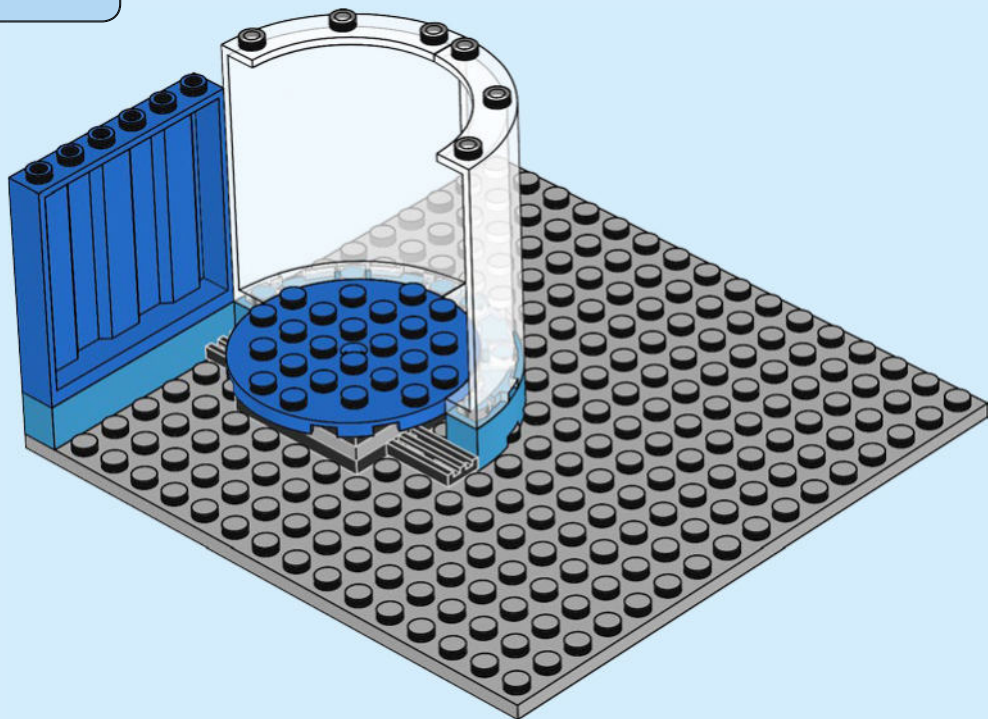

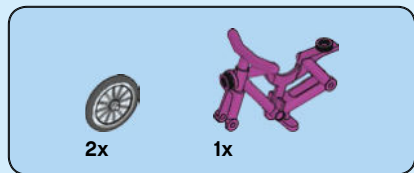

7

1

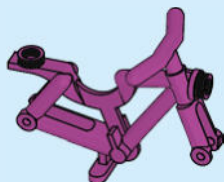

2

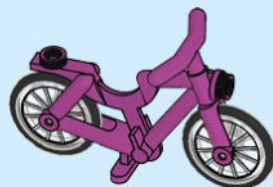

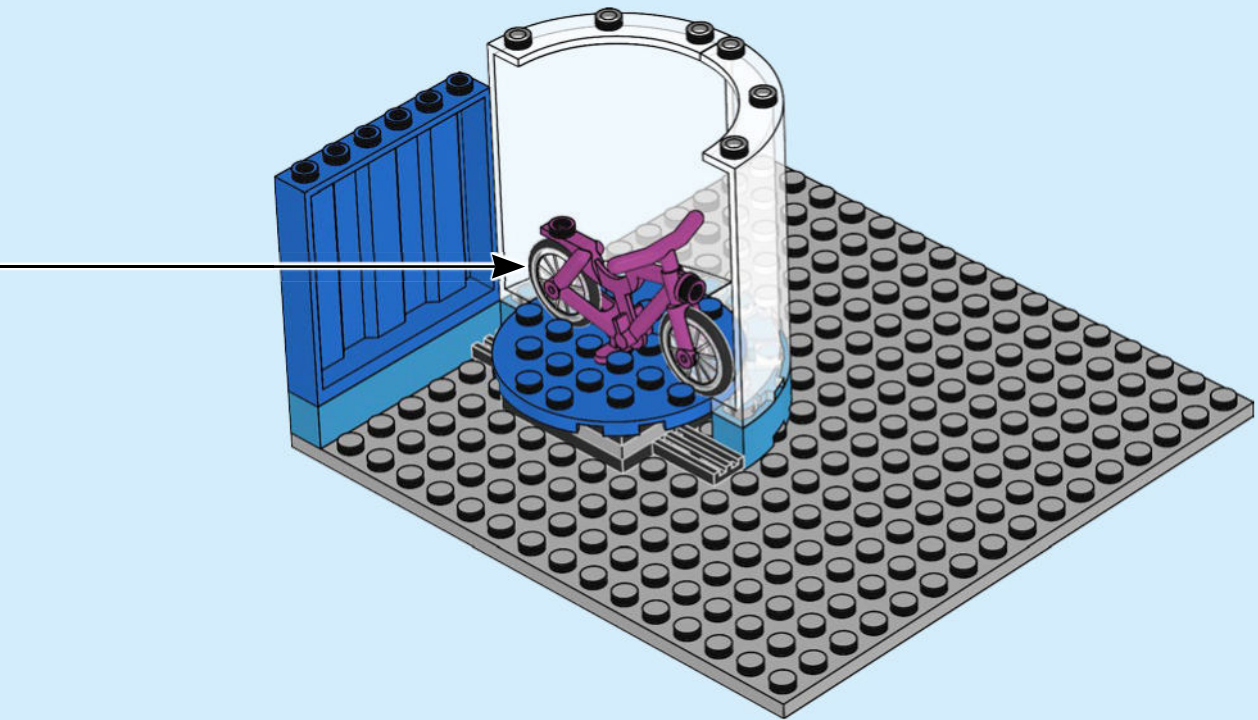



2x

8

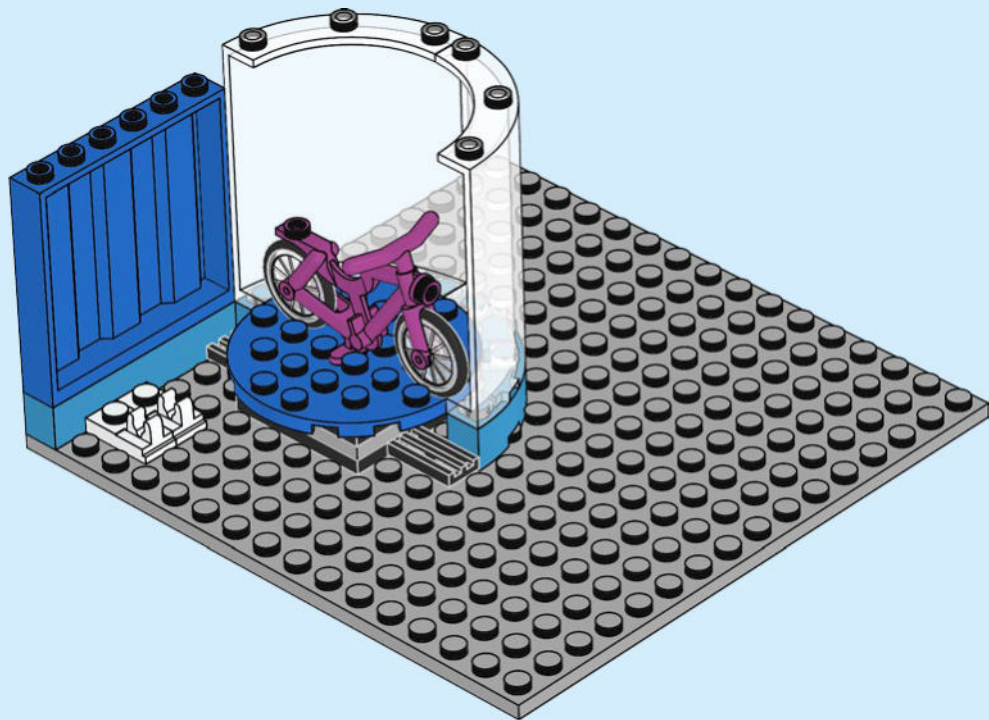

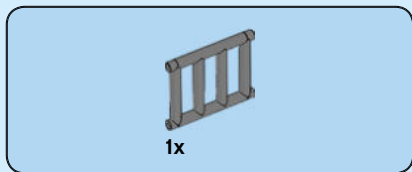

9

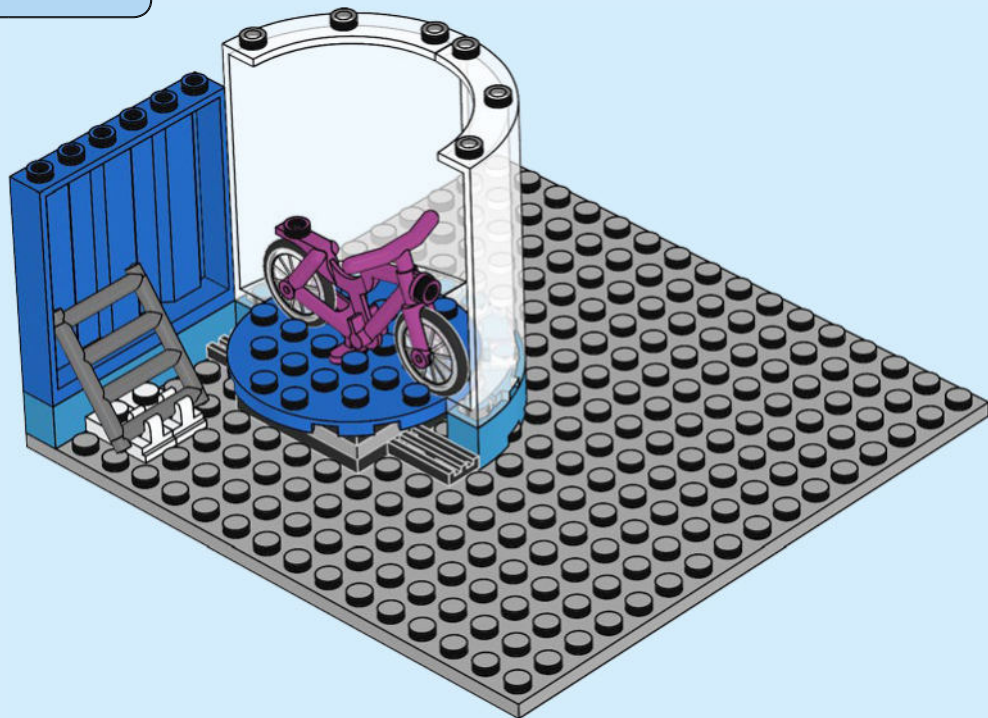



2x



2x



1x



1x

10

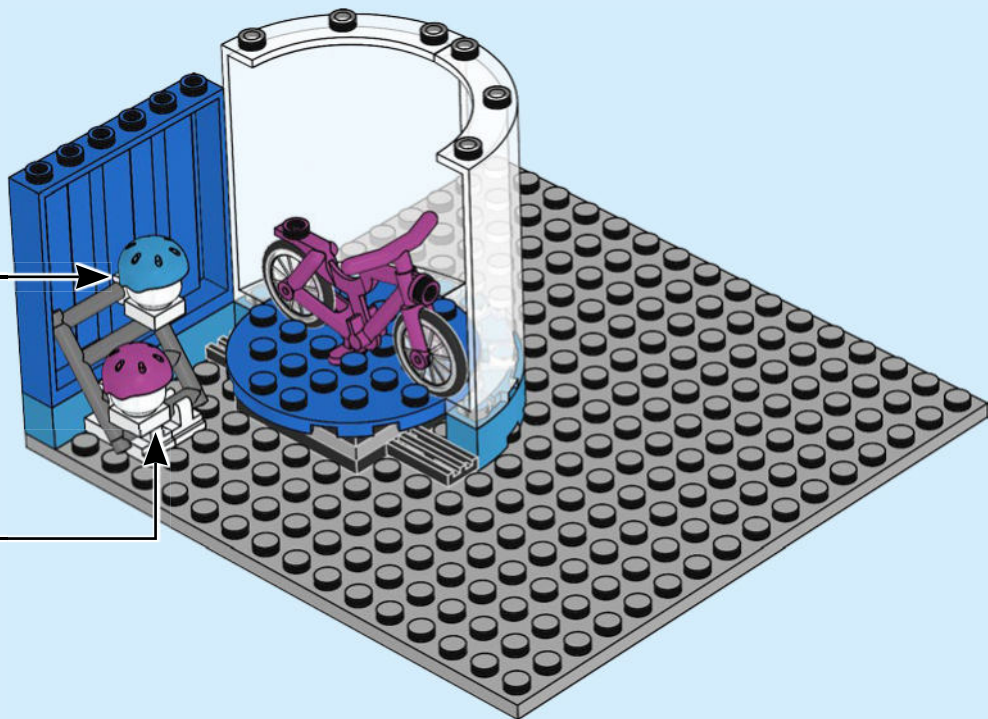
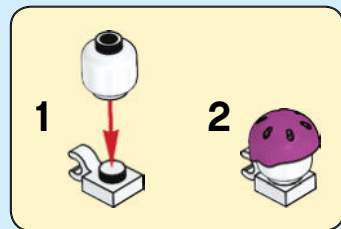
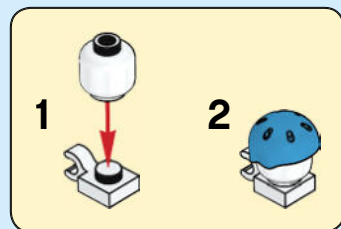

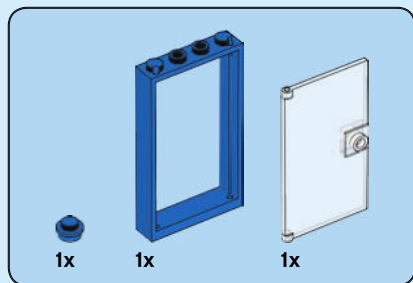

11

1

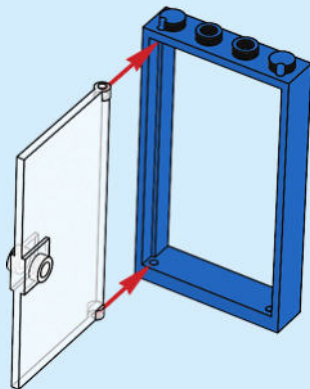

2

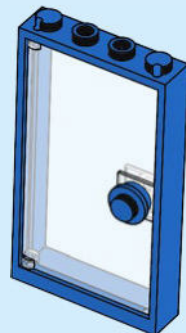

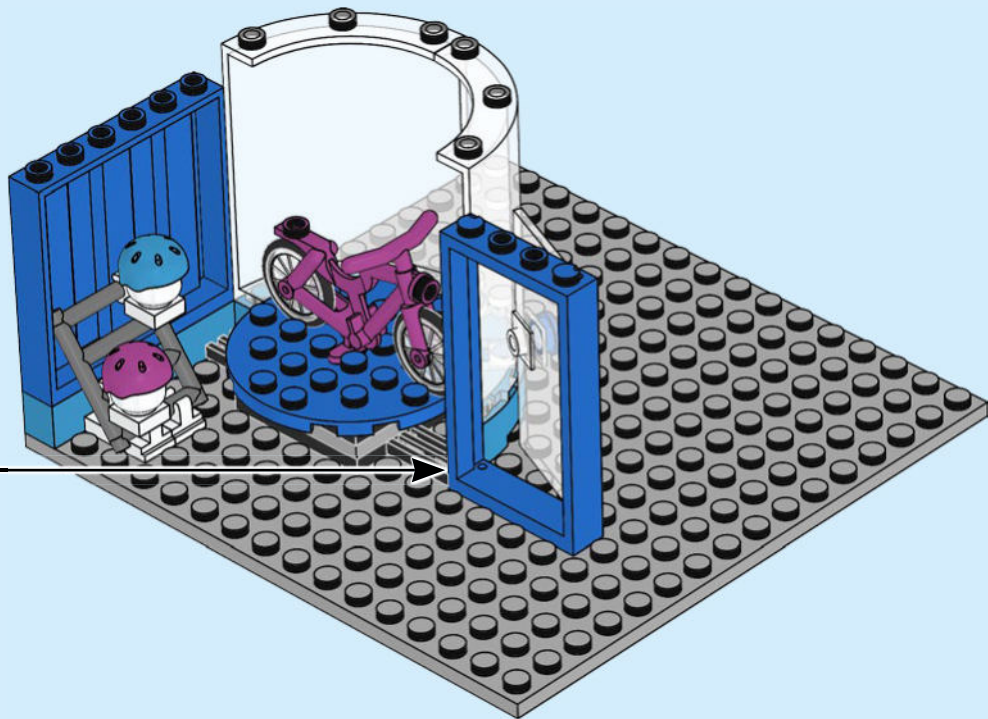

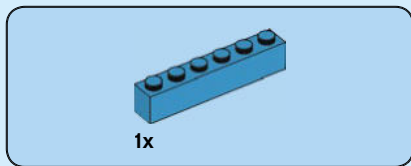

12

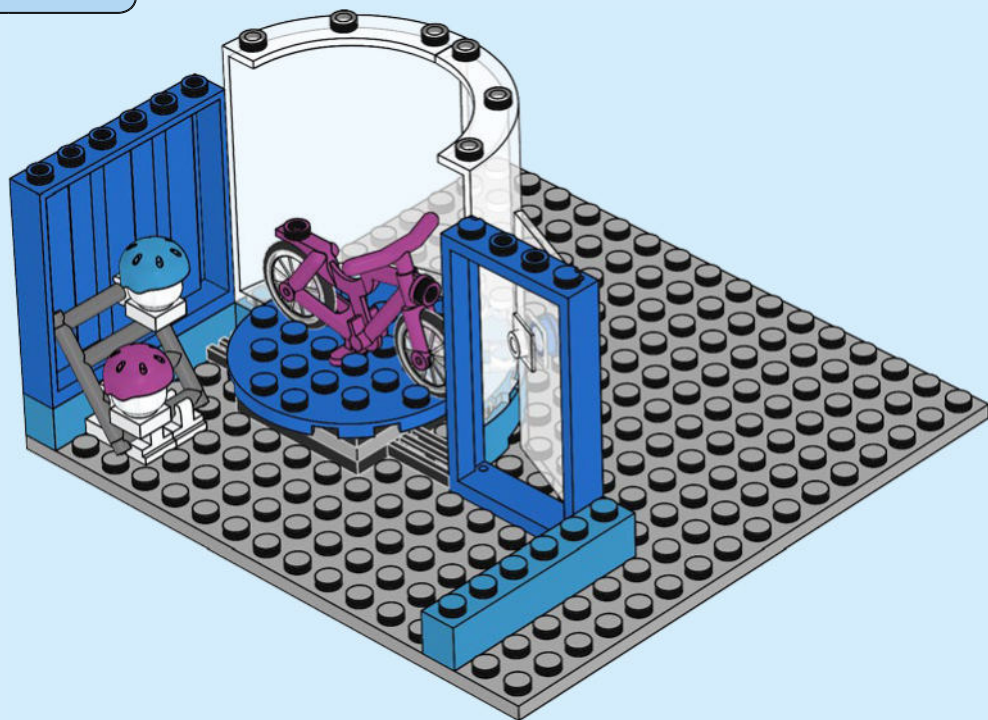

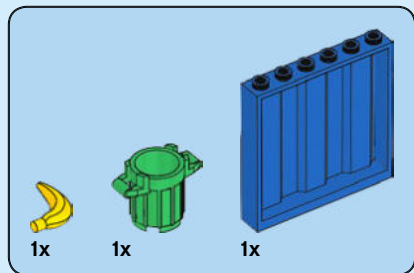

13

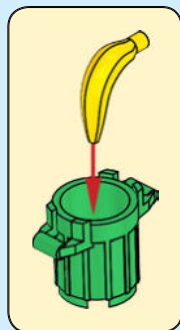
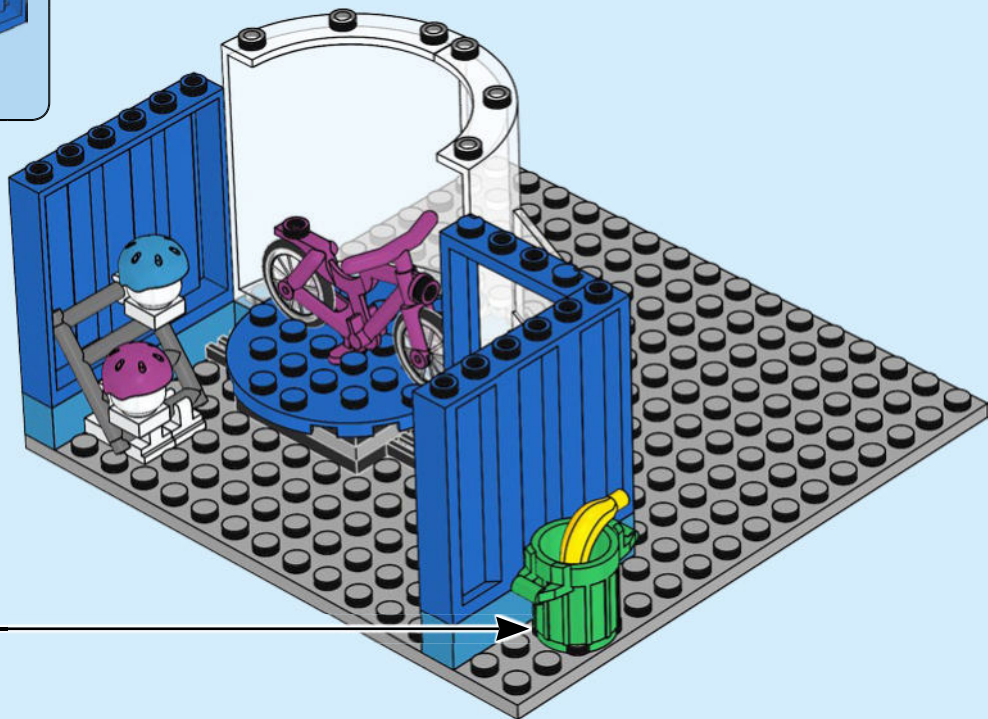

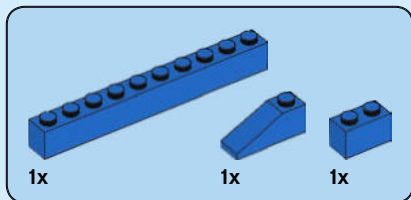

14

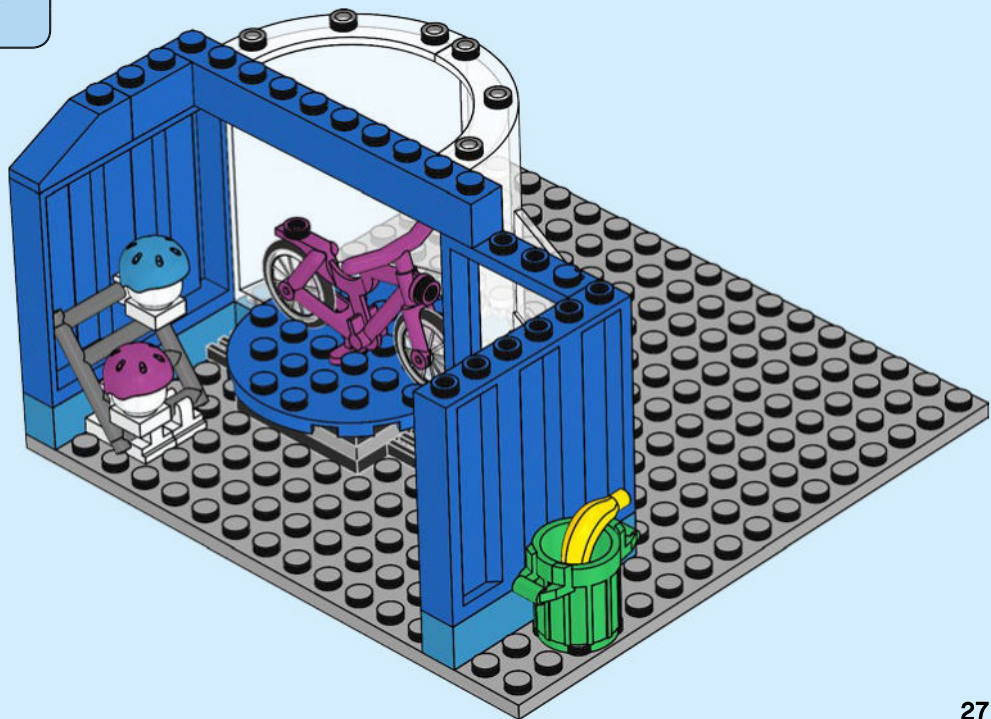

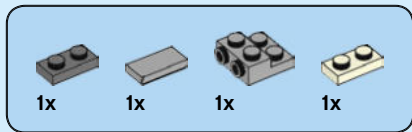

15

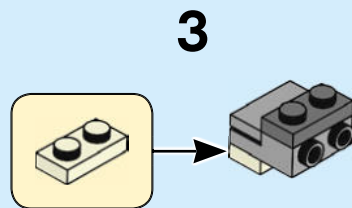
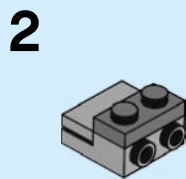
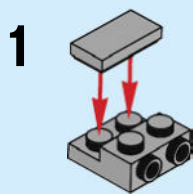

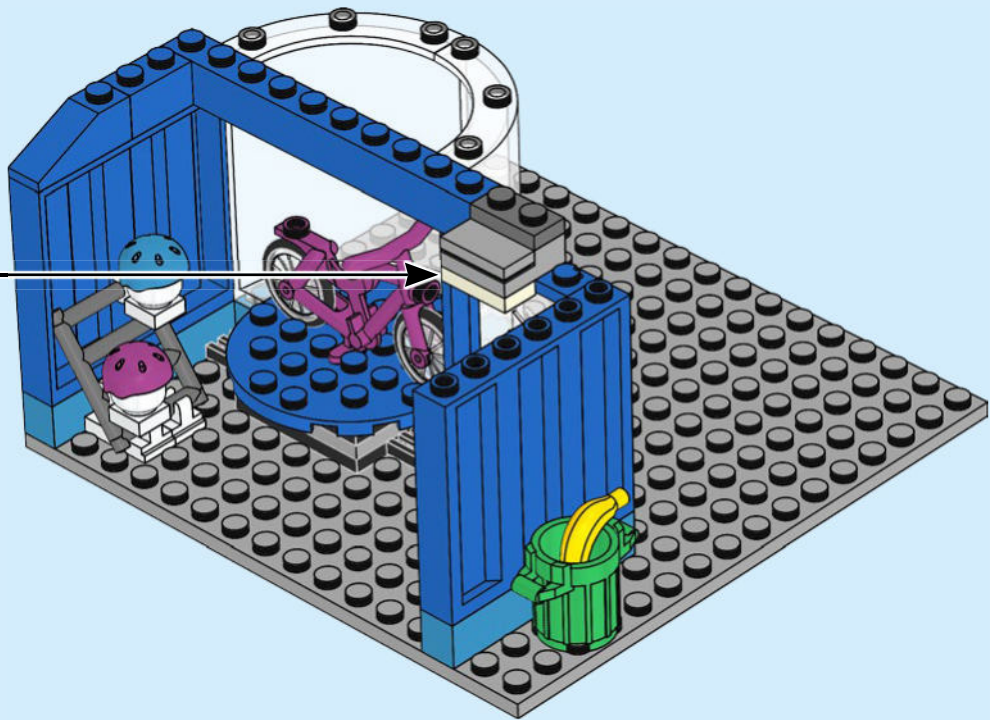



2x



1x

16

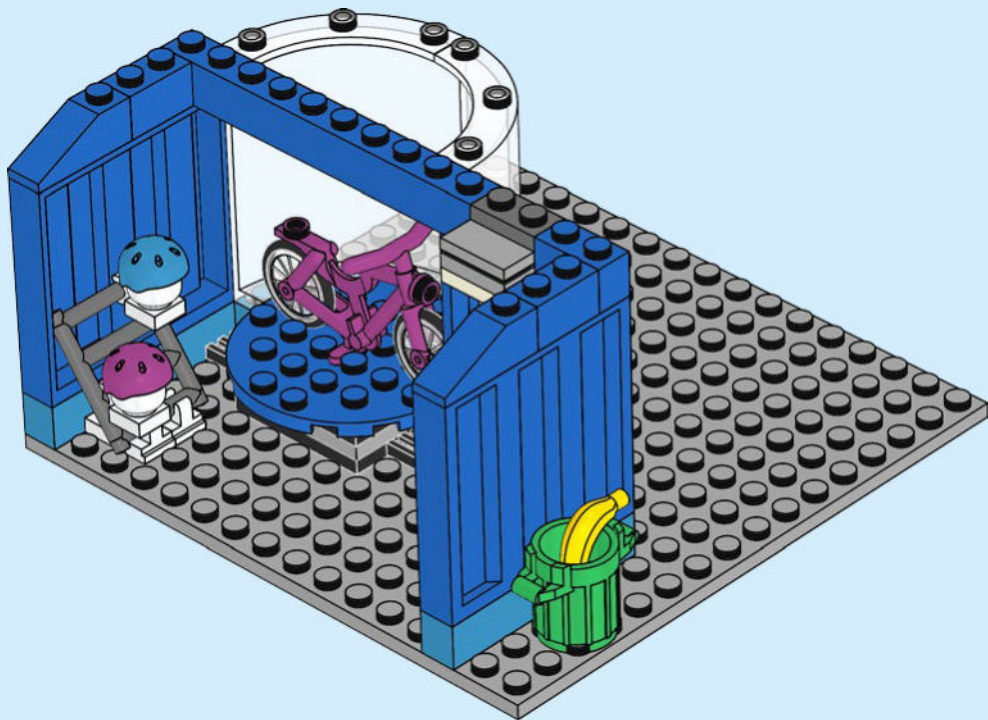

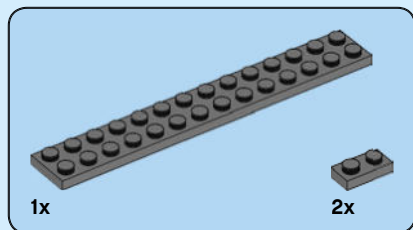

17

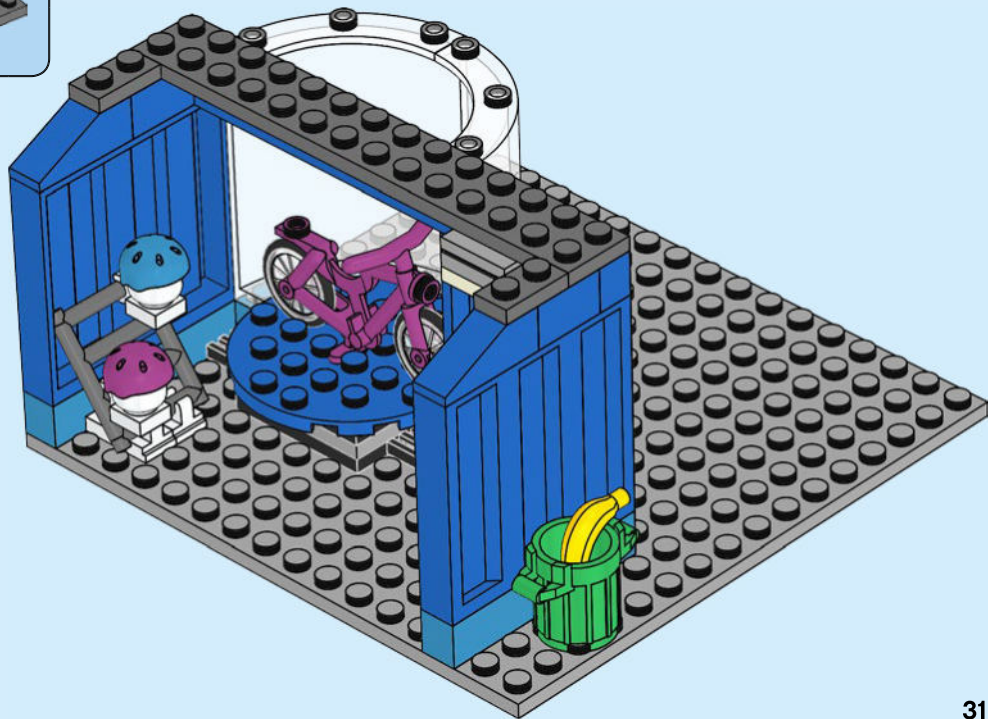

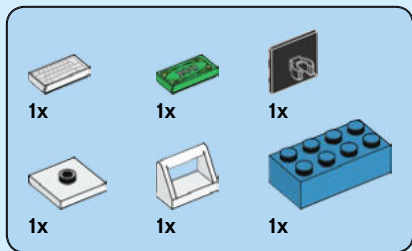

18

1

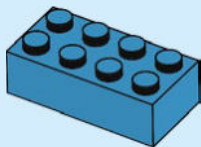

2

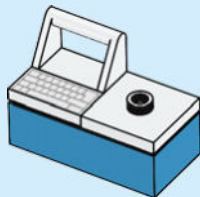

3



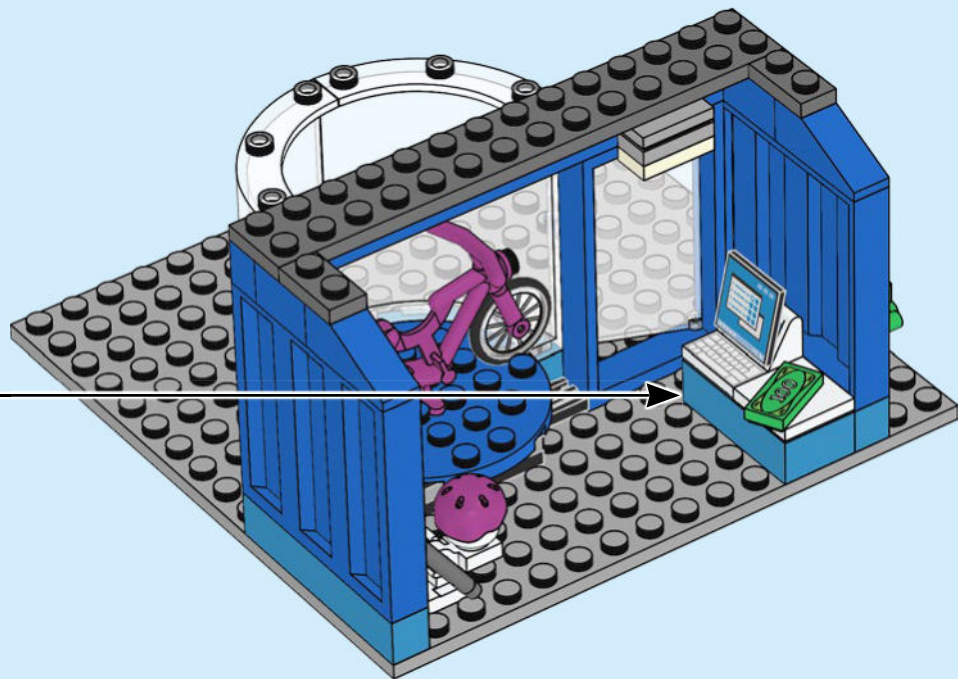

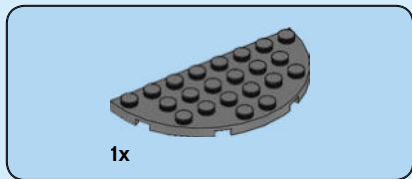

19

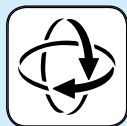



3x

20



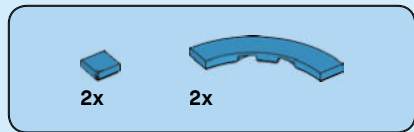

21

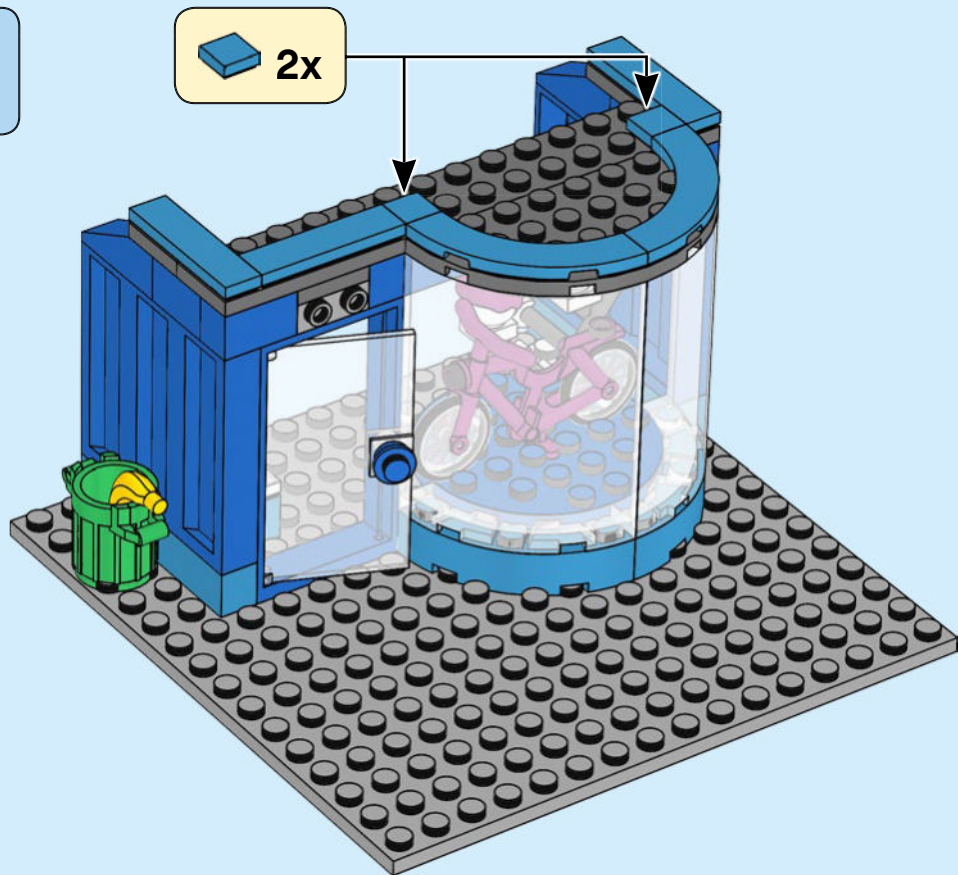



2x



1x

22

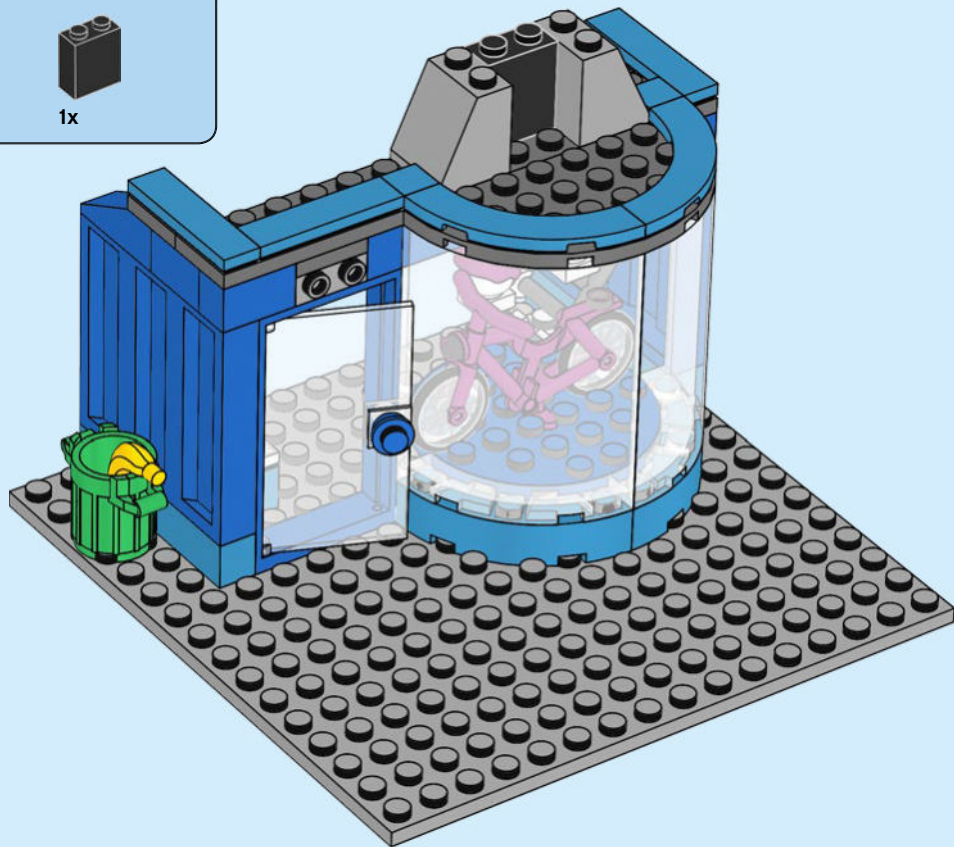



4x

23

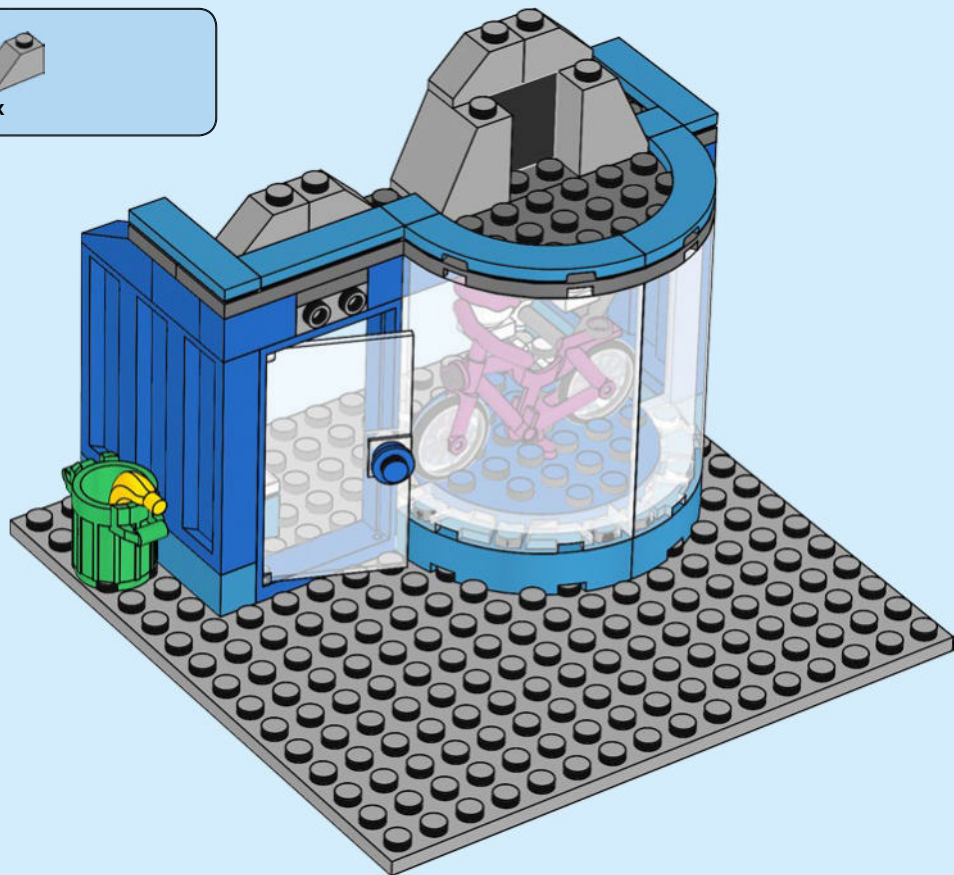

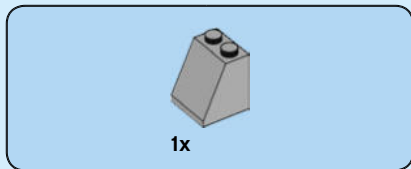

24





3x

25





1x

26

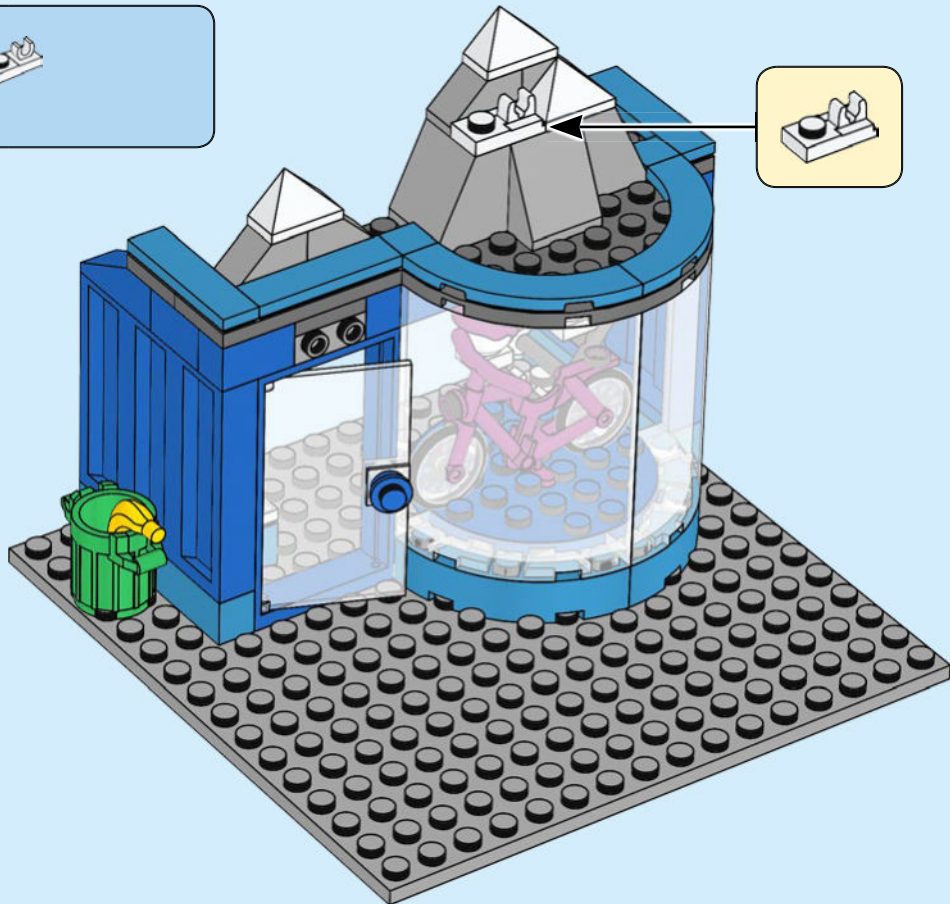

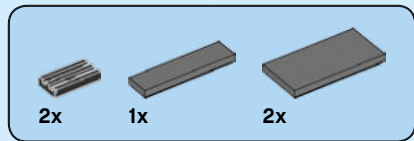

27

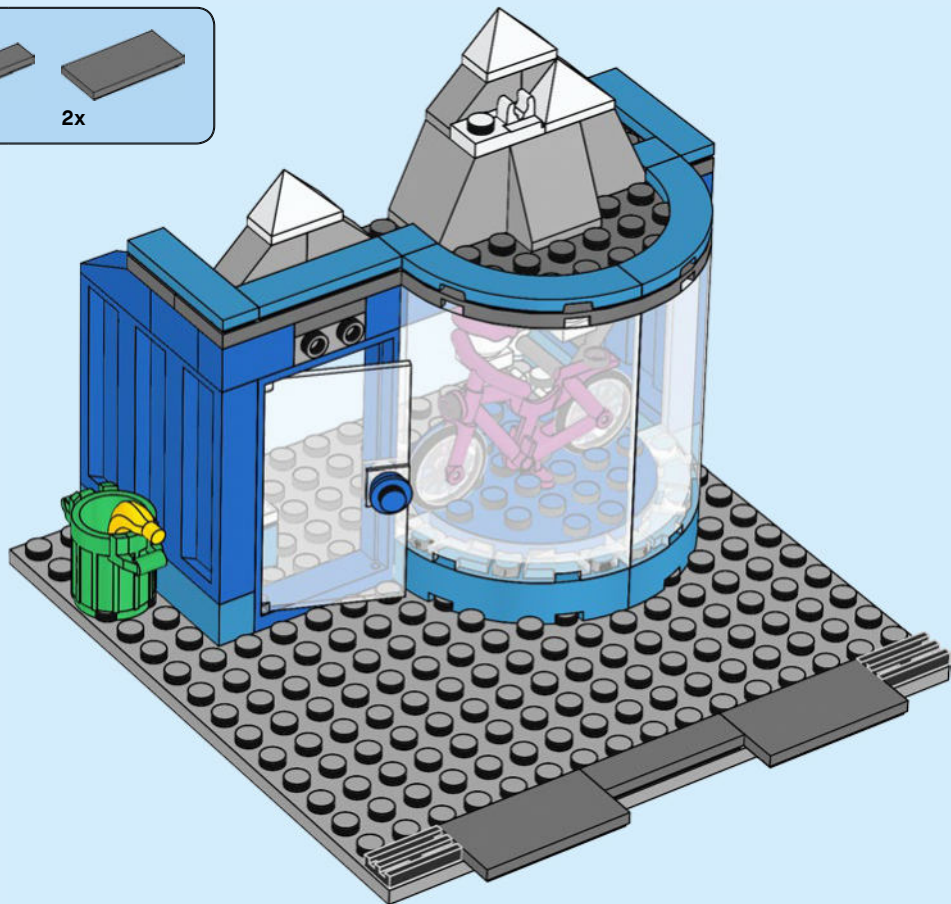

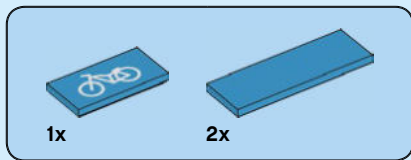

28

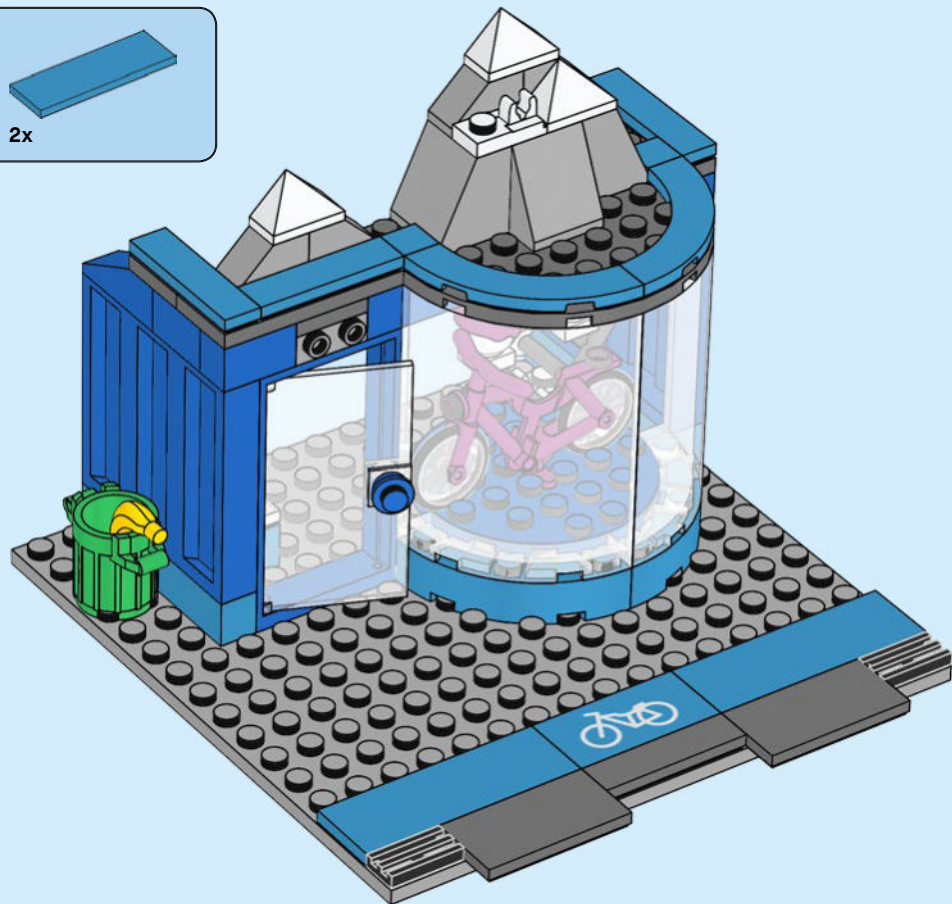

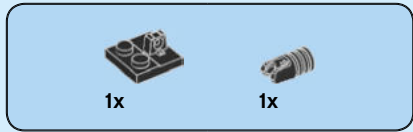

29

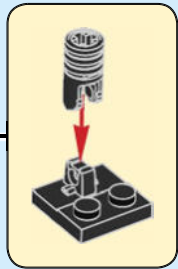
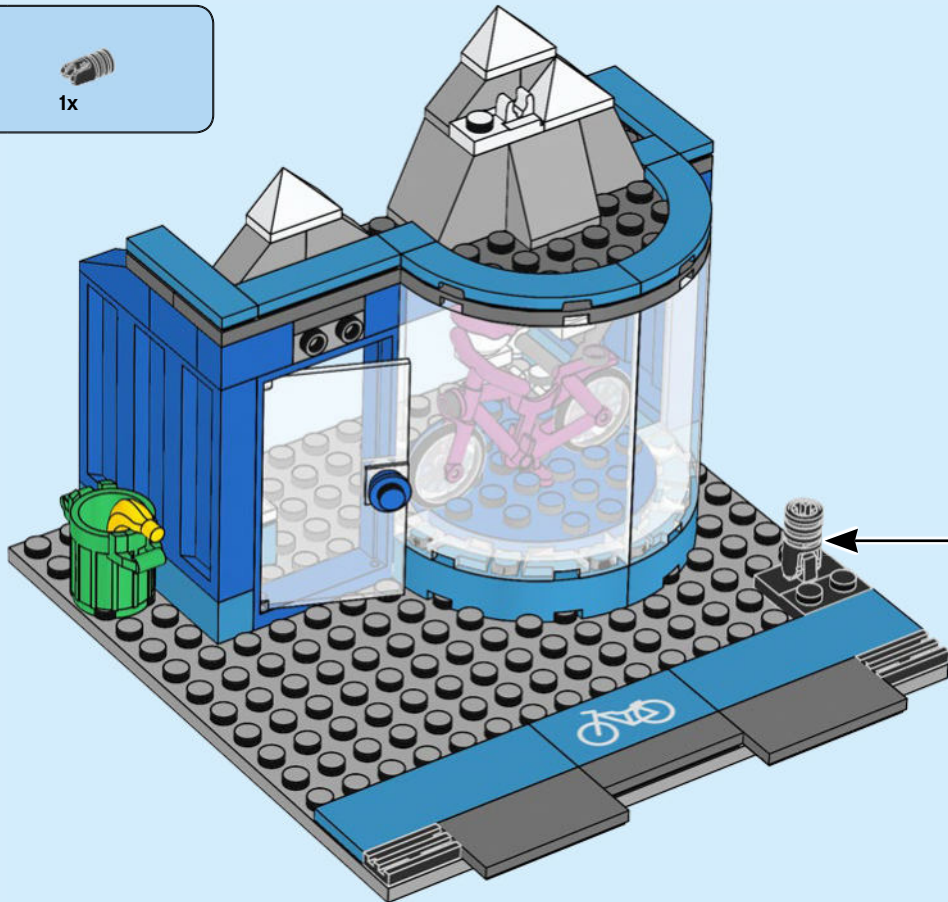

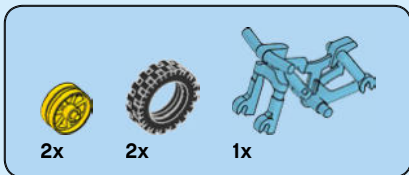

30

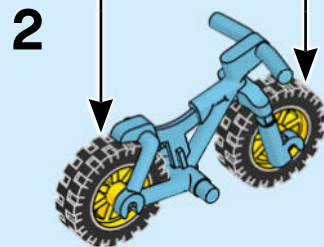
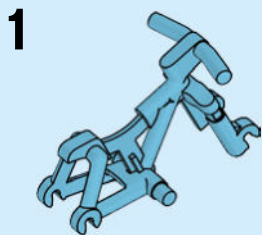

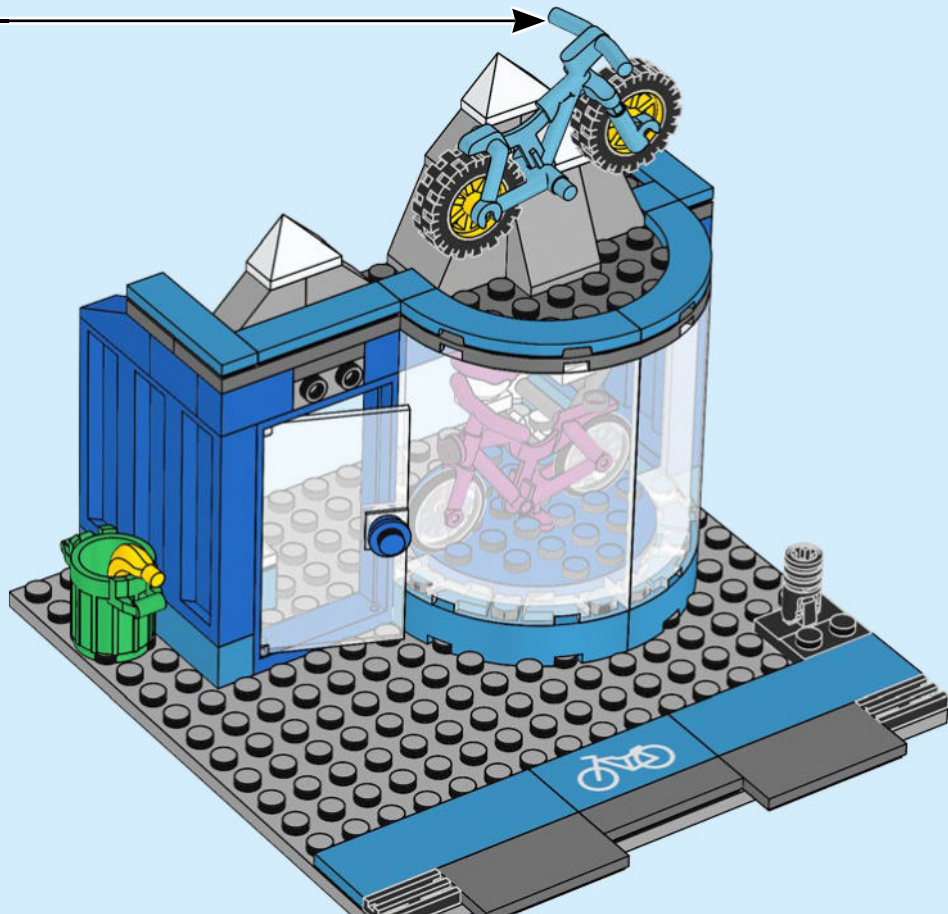

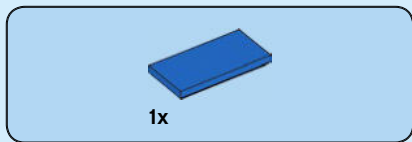

31

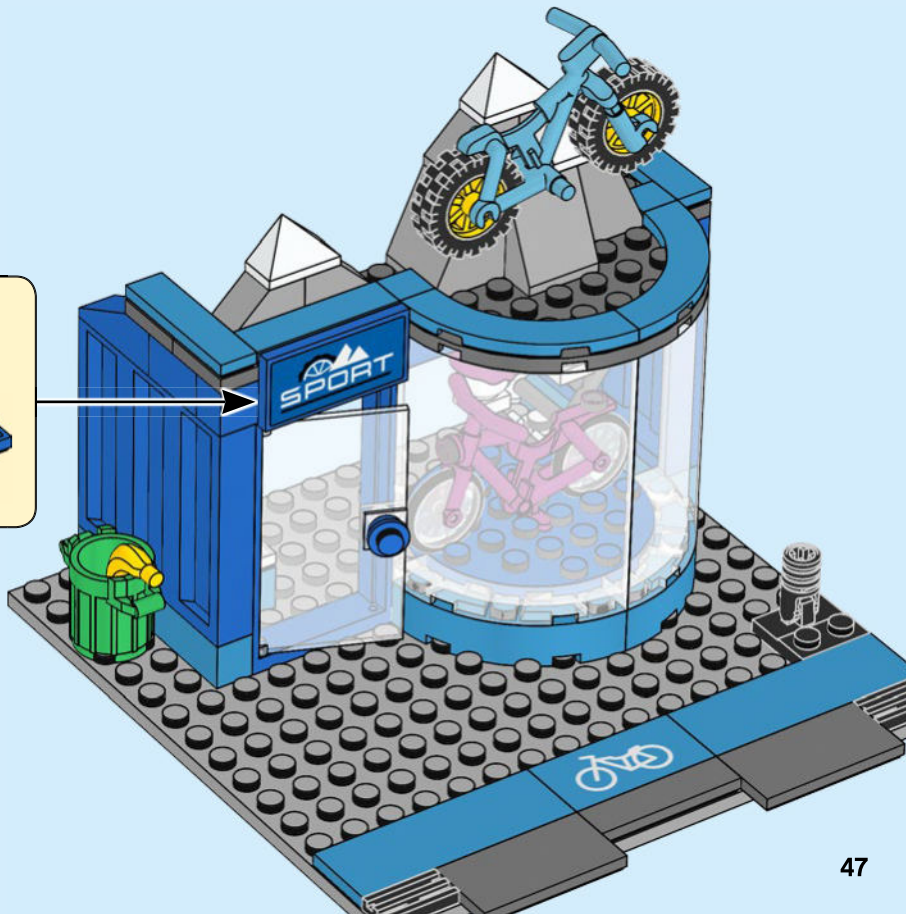
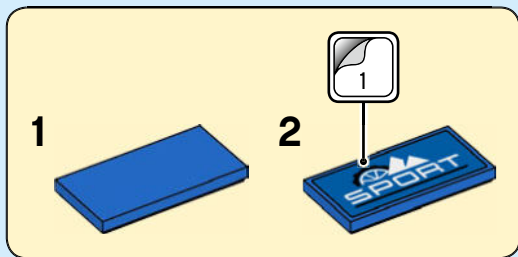

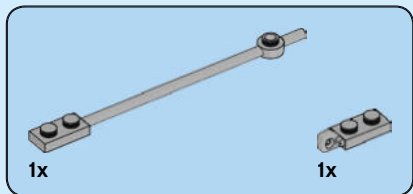

32

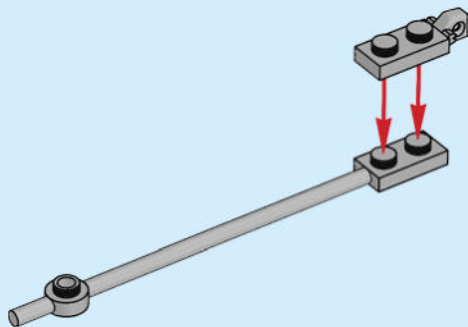



1x

33

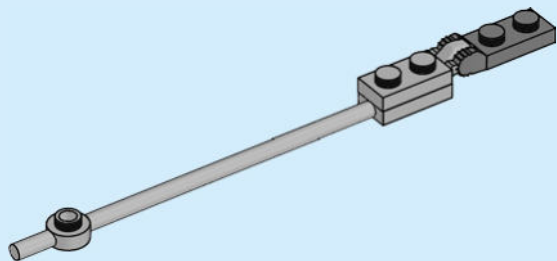

1x

34

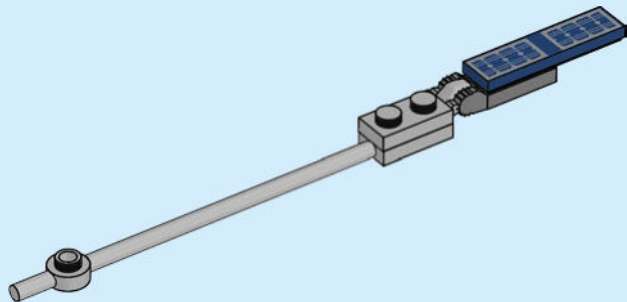



1x

35

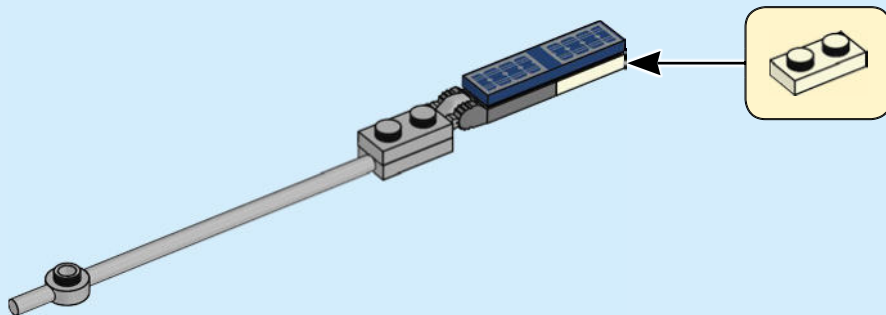

36

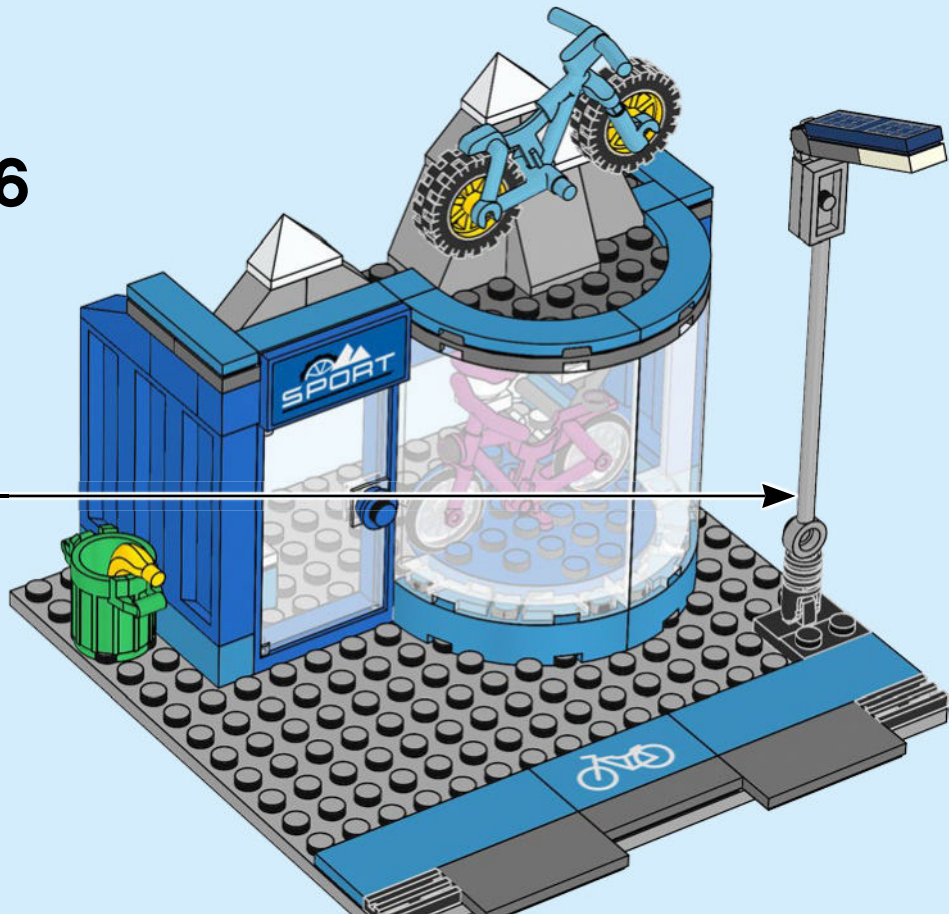



CITY



60277



60275



60276



CITY

60306



5

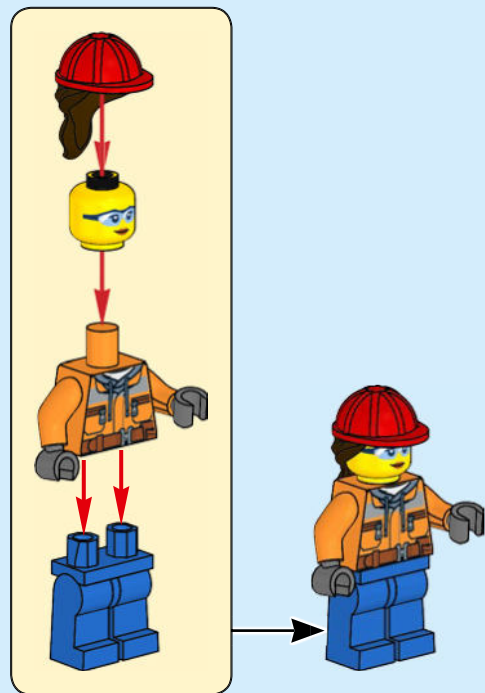
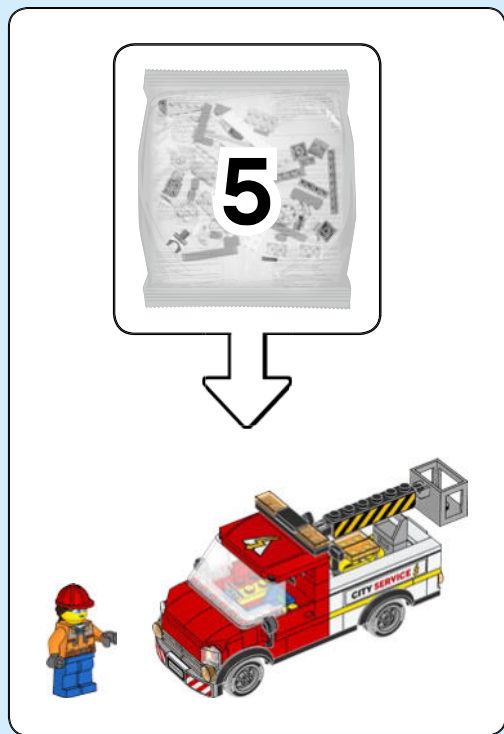

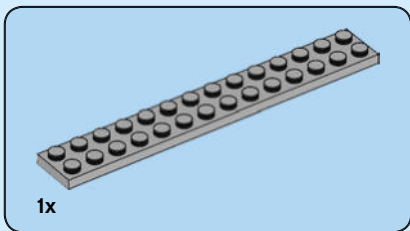

1x

1

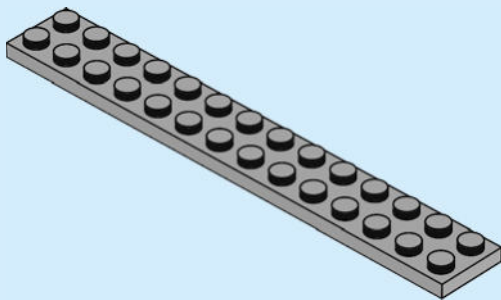



2x

2



2x

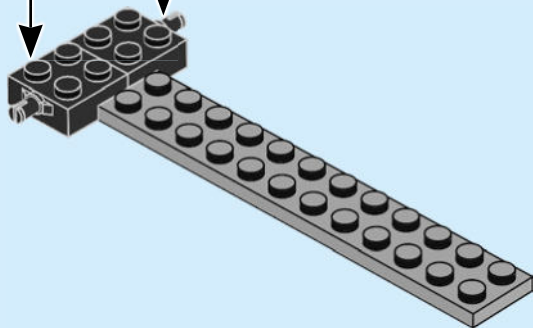

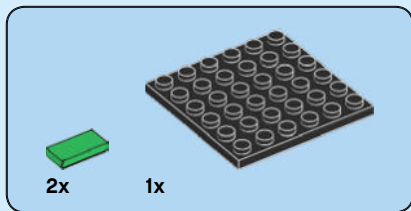

3

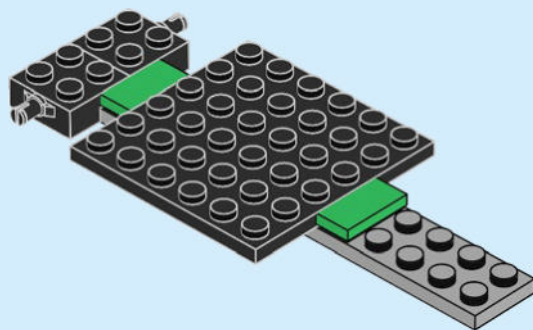



2x

4

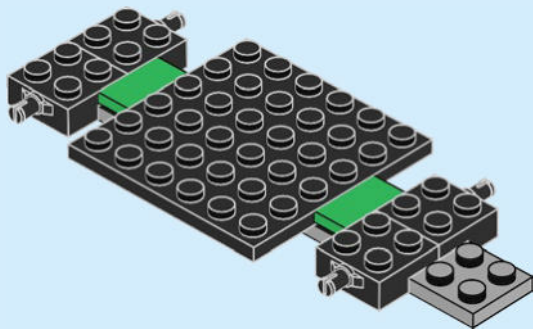

6

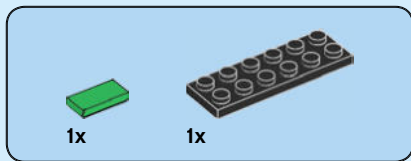

5

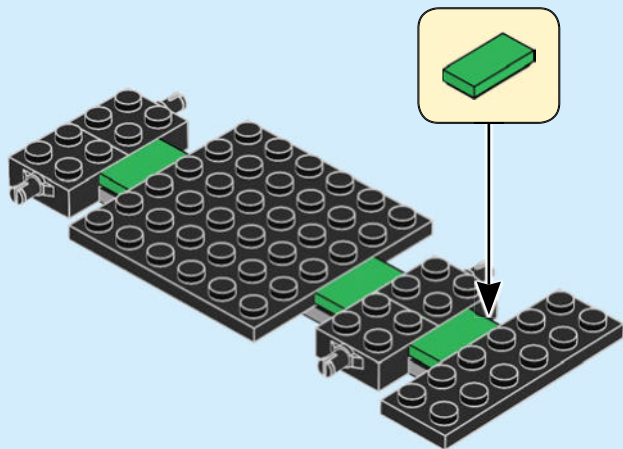

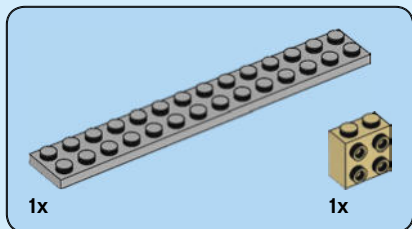

6

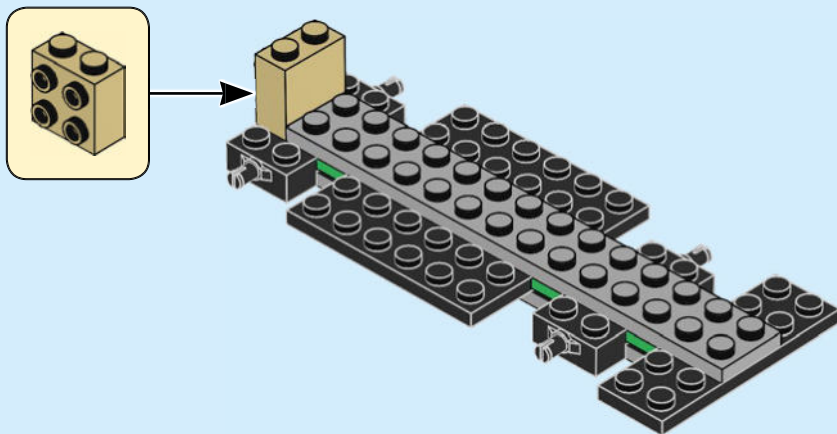

8



2x

7

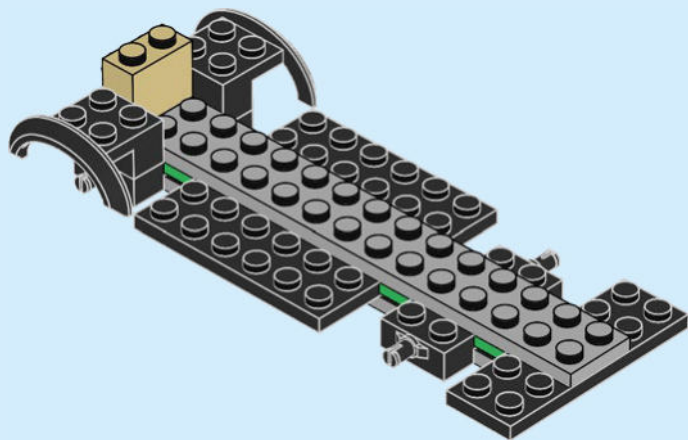



1x



1x

8

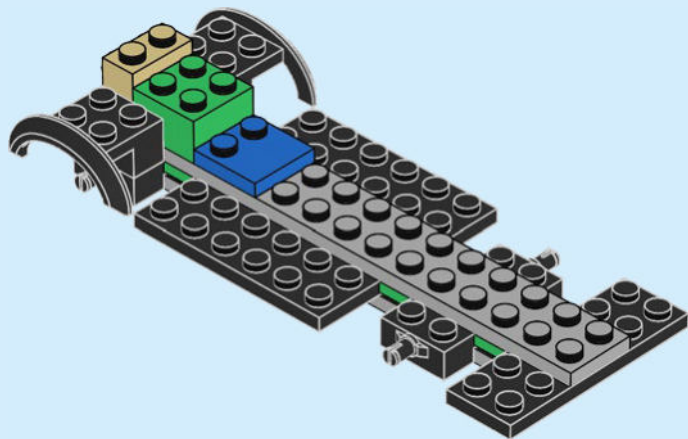



1x

9

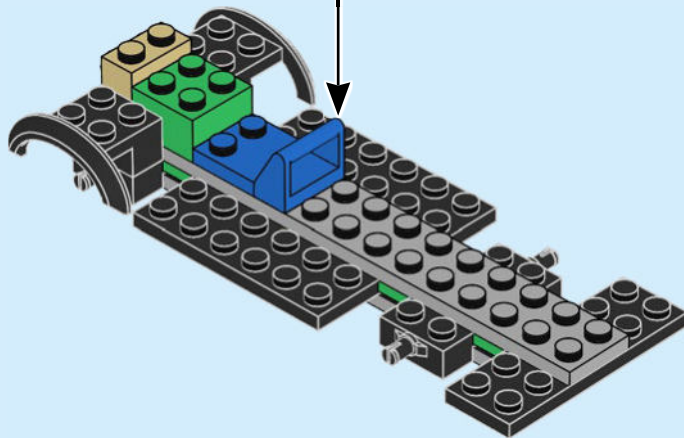



1x

10

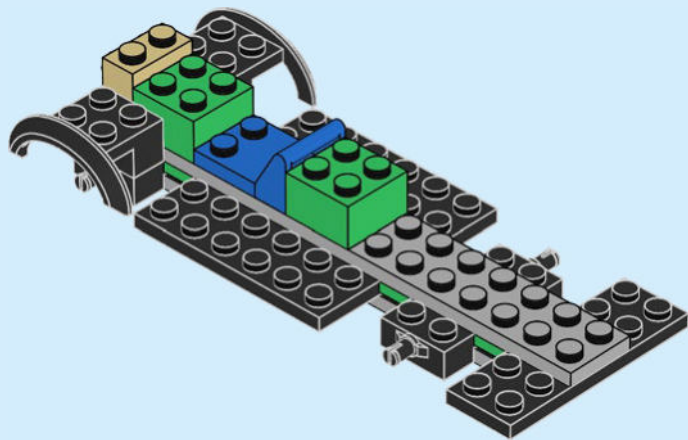

12

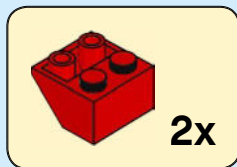

11

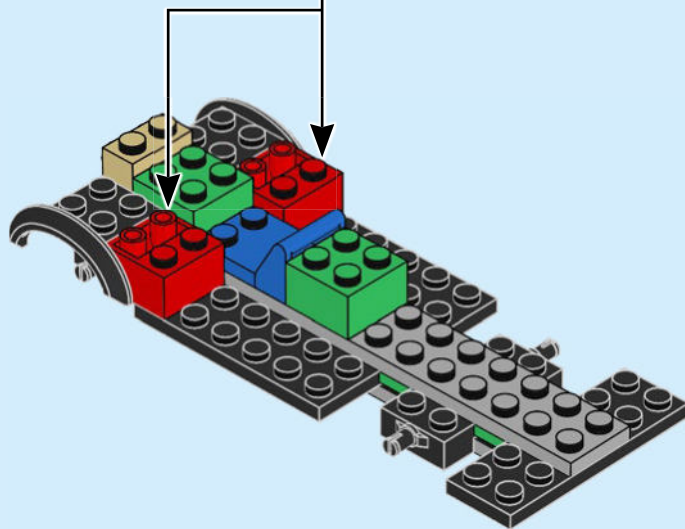

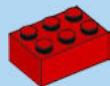

2x

12

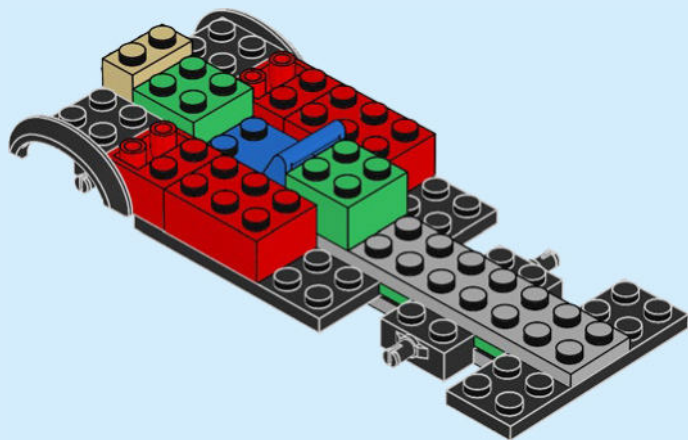

14



2x

13

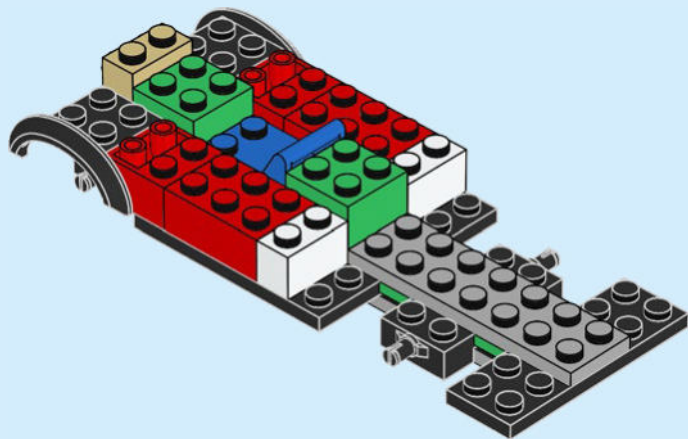



2x

14

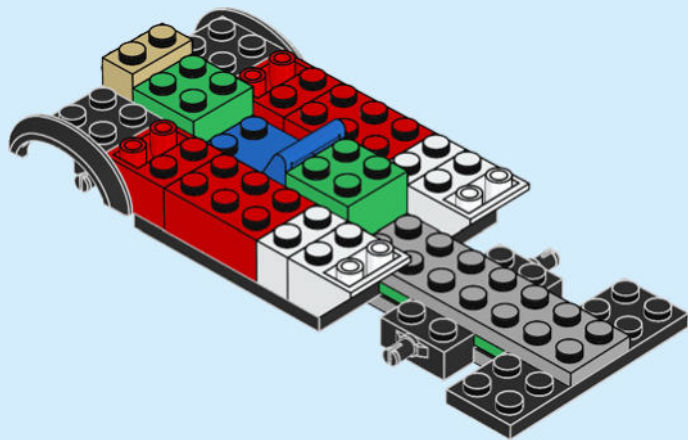



2x

15

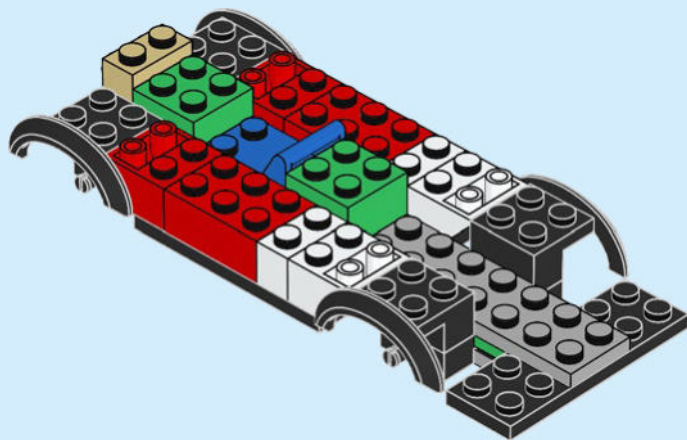



2x

16

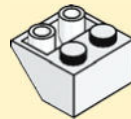

2x

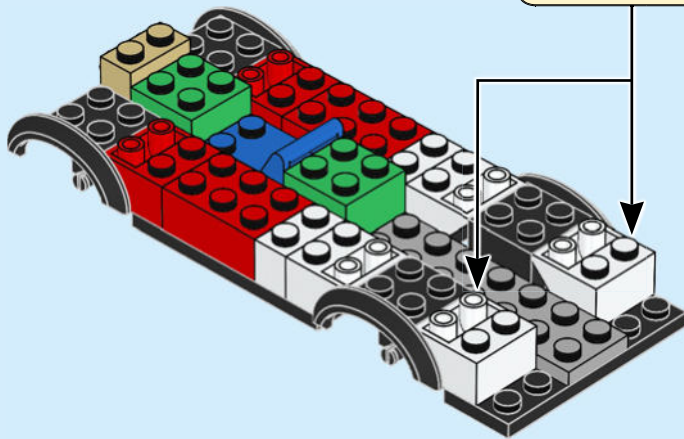

18



2x



2x

17

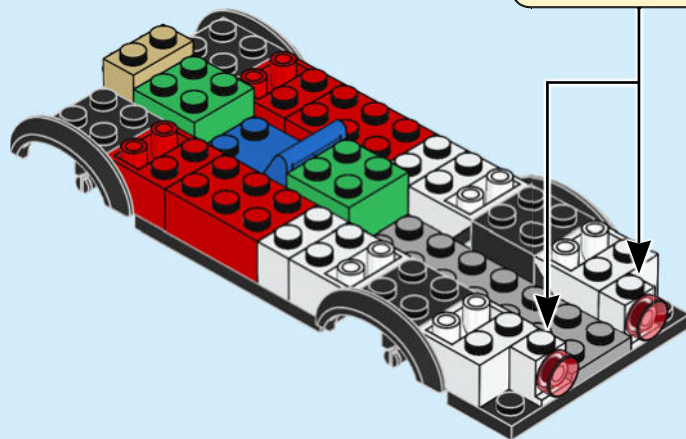

2x



2x



2x

18

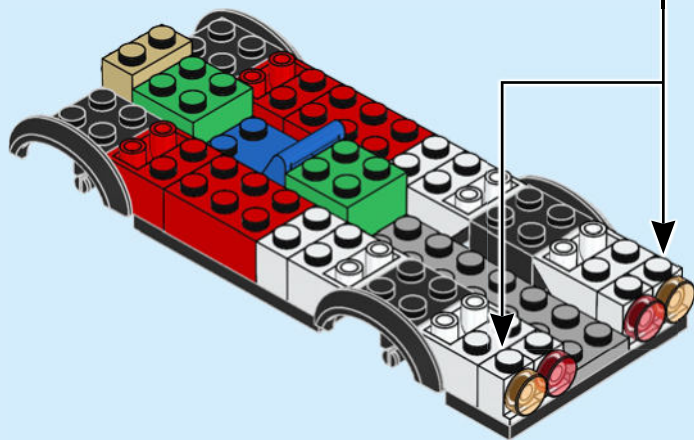
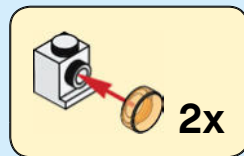



2x



1x

19

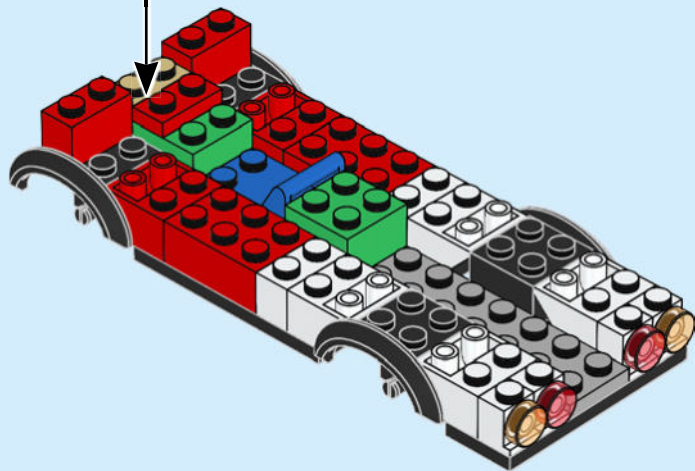
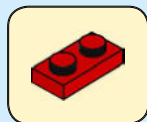

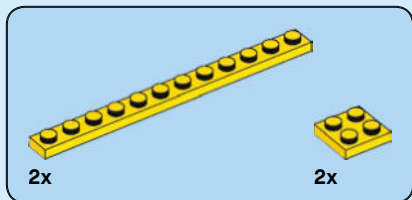

20

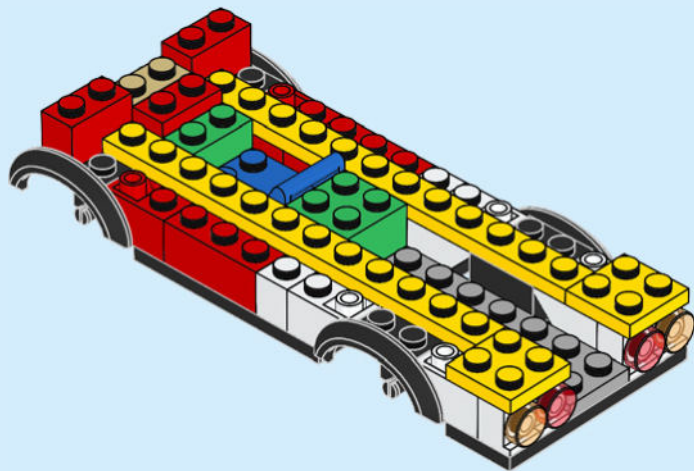

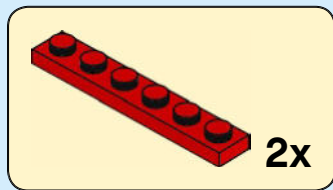
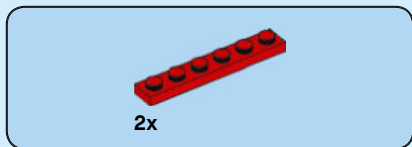

21

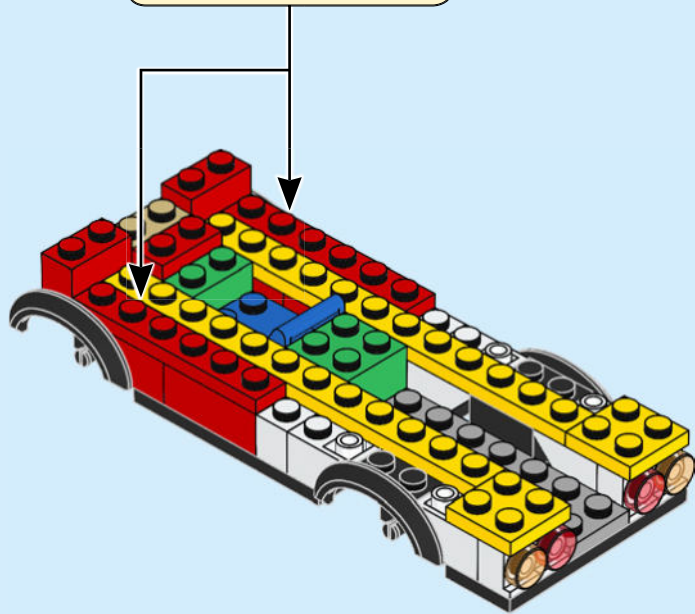



2x

22

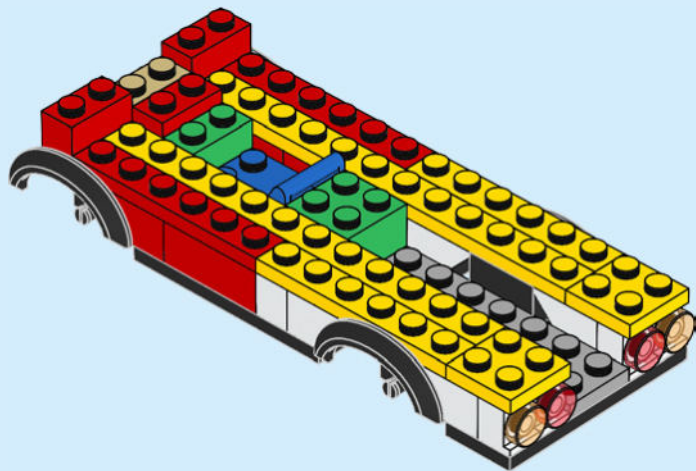

24



1x

23

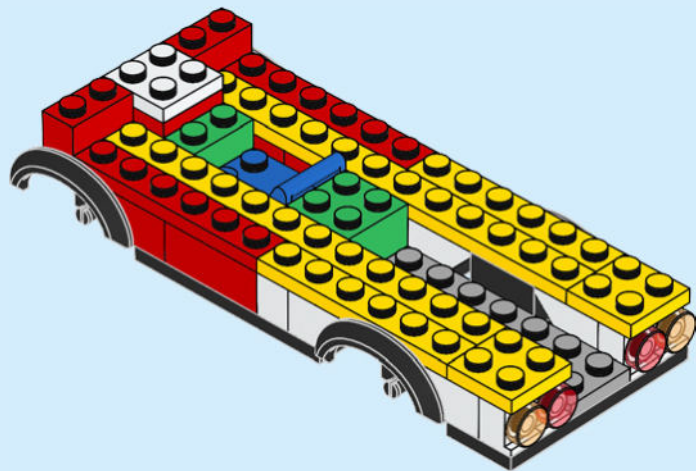



2x



1x

24

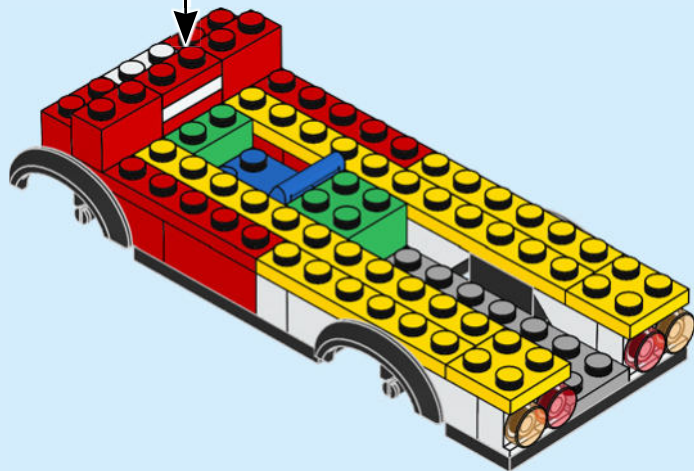



1x

25

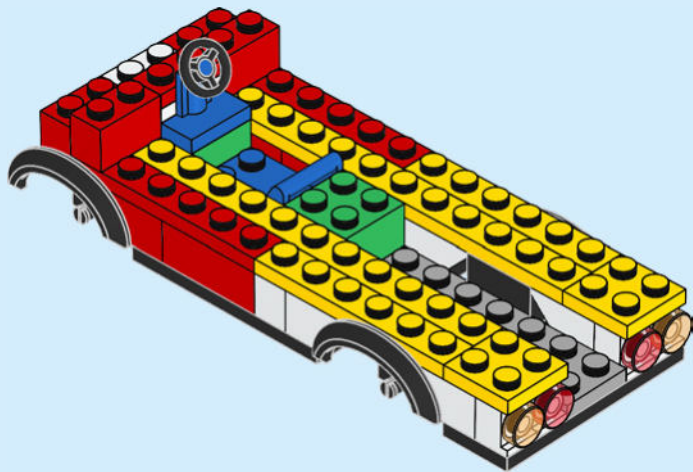



2x

26



2x

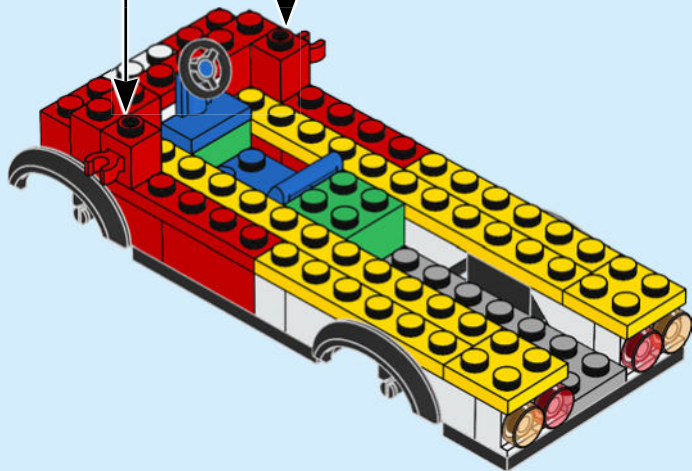

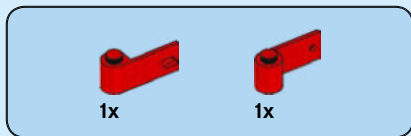

27

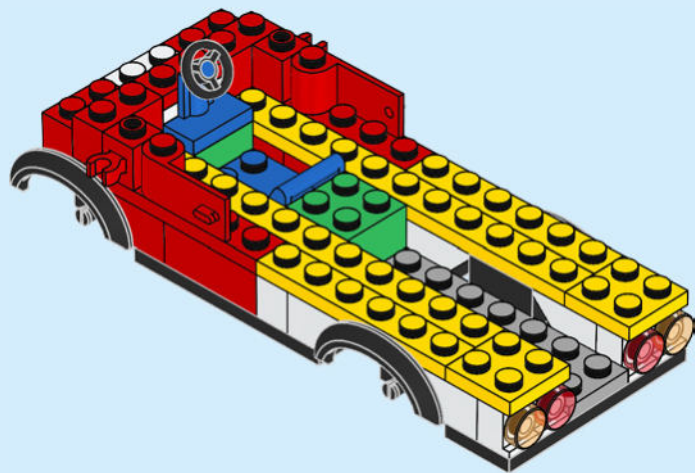

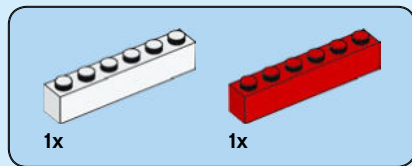

28

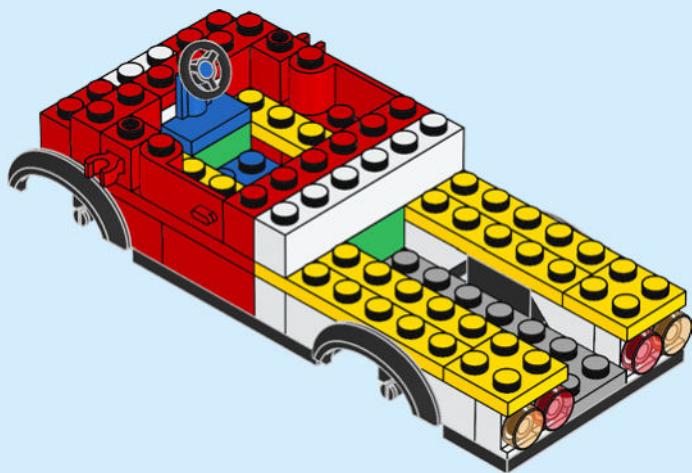

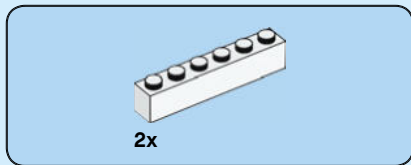

29

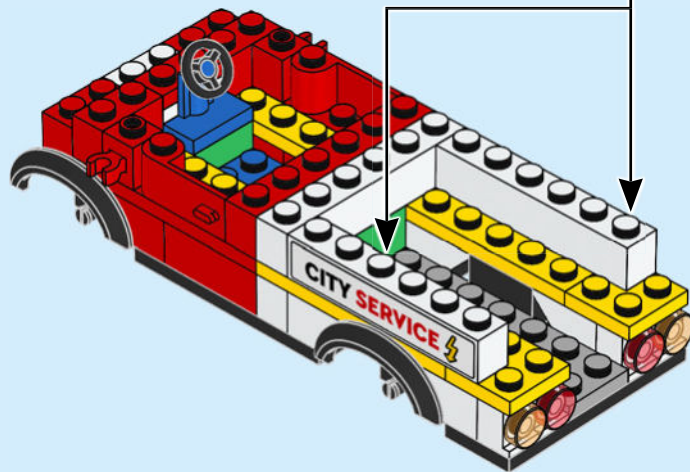
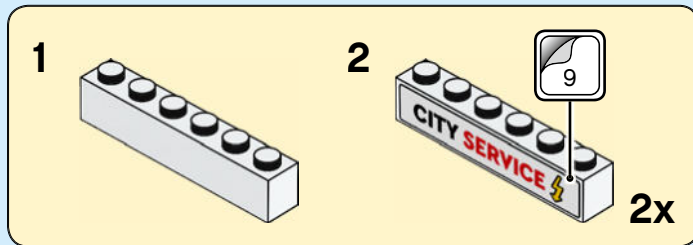

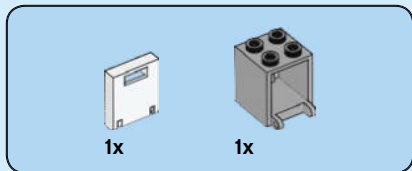

30

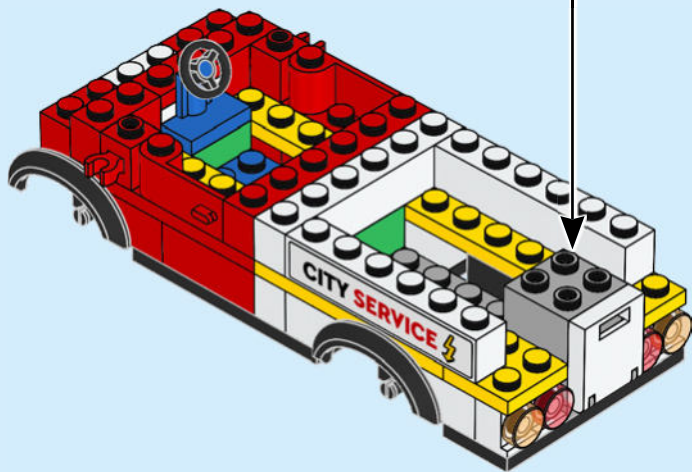
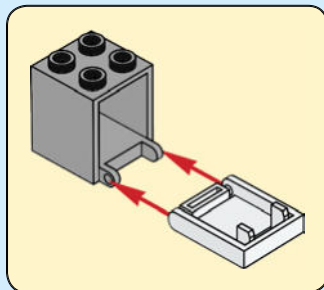



2x

31

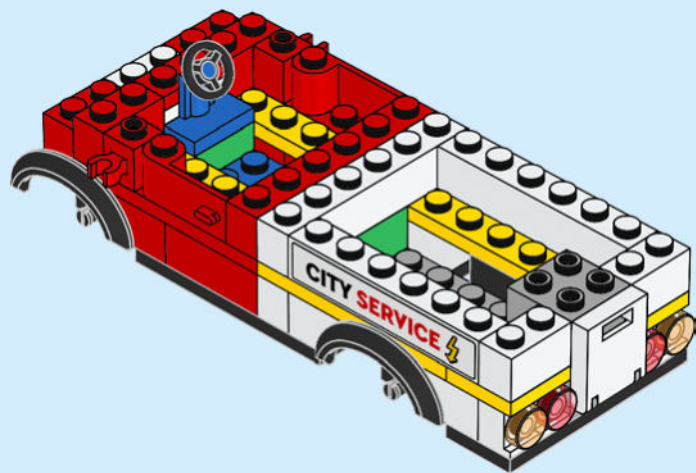

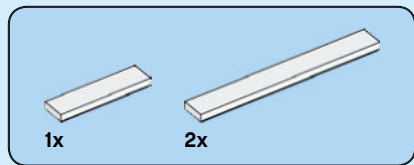

32

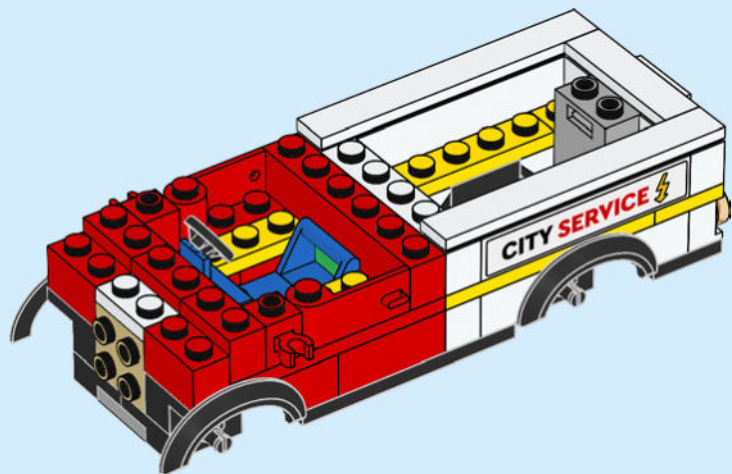



1x

33

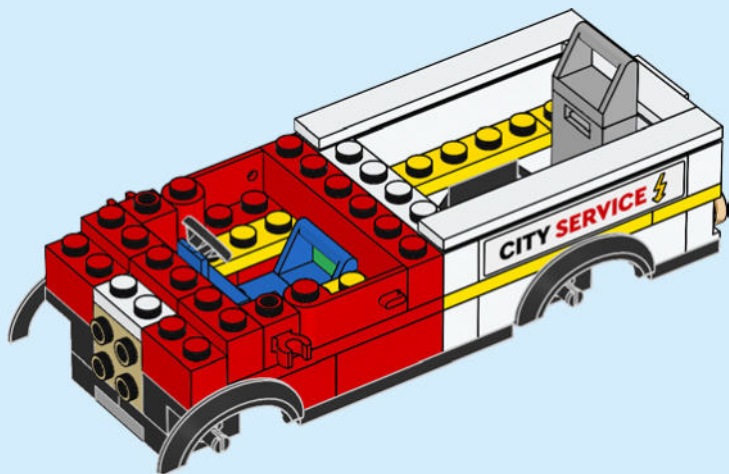



2x

34

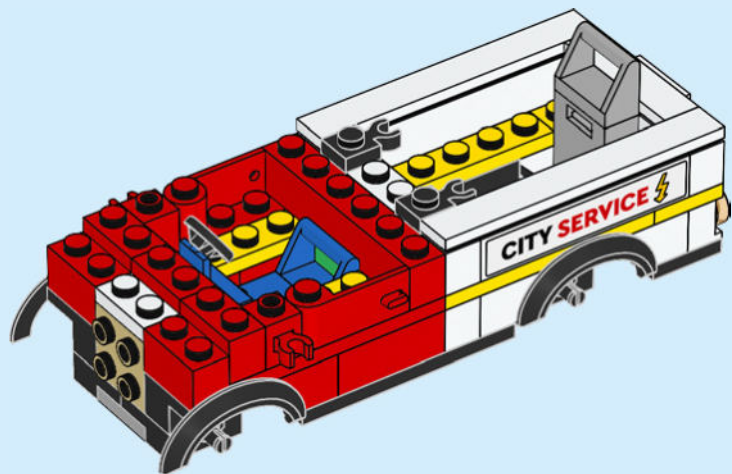

36

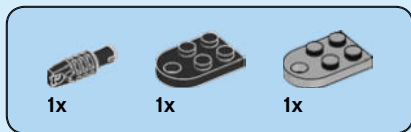

35

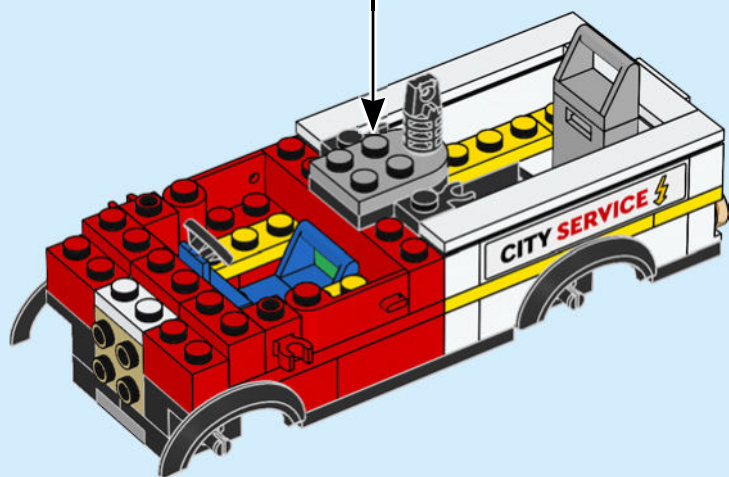
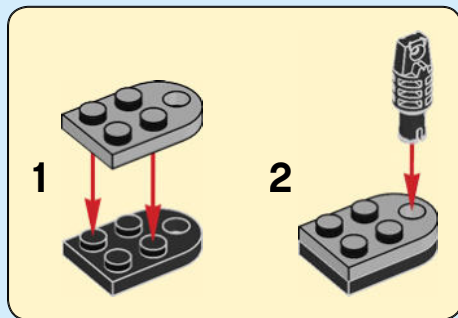



1x

36

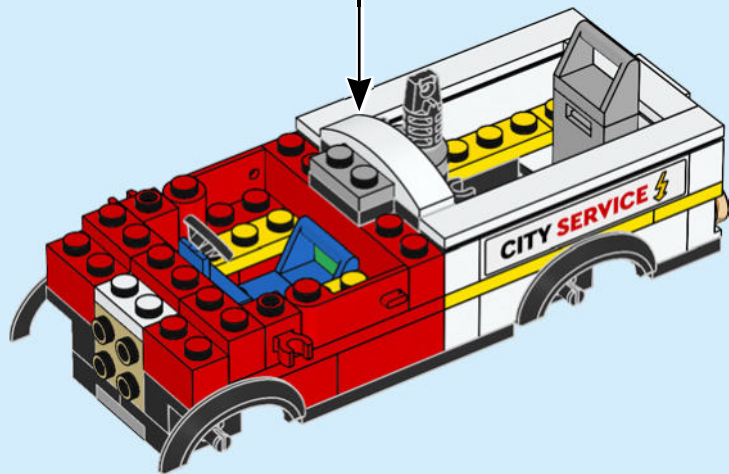

38



1x

37

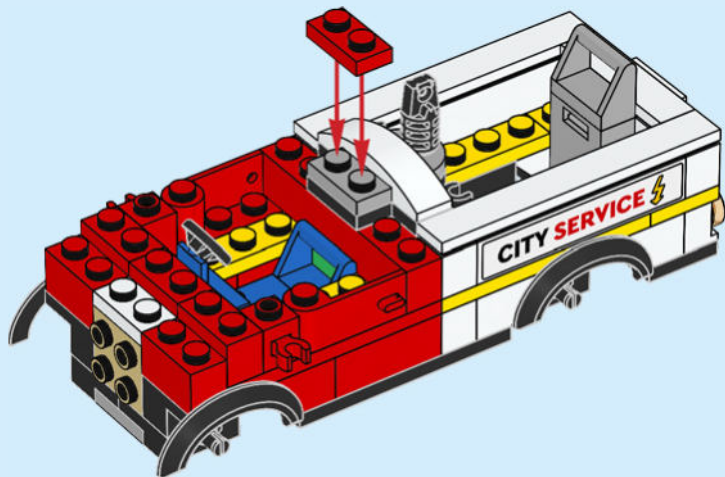



2x

38

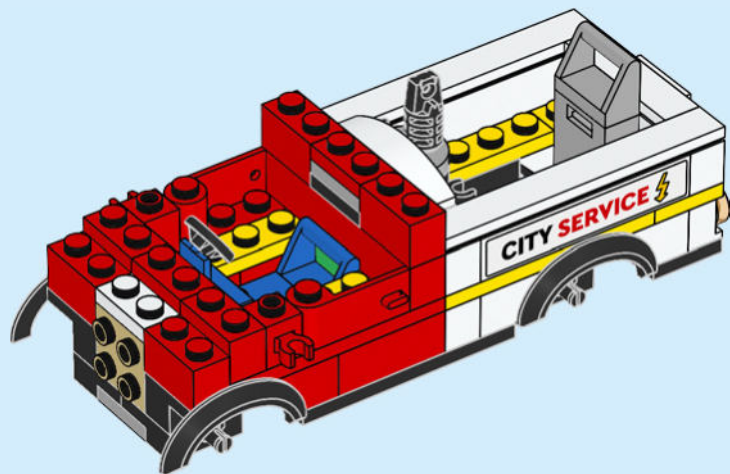



2x



1x

39

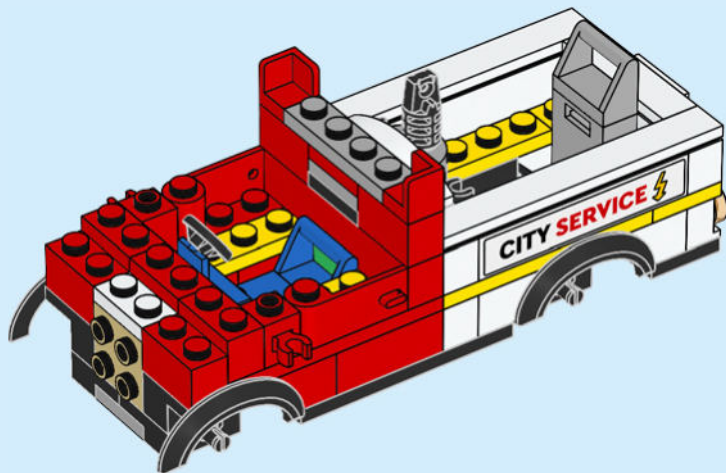

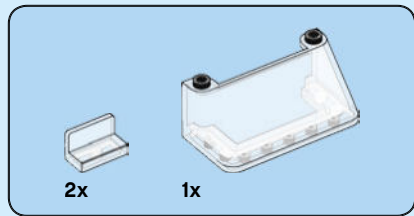

40

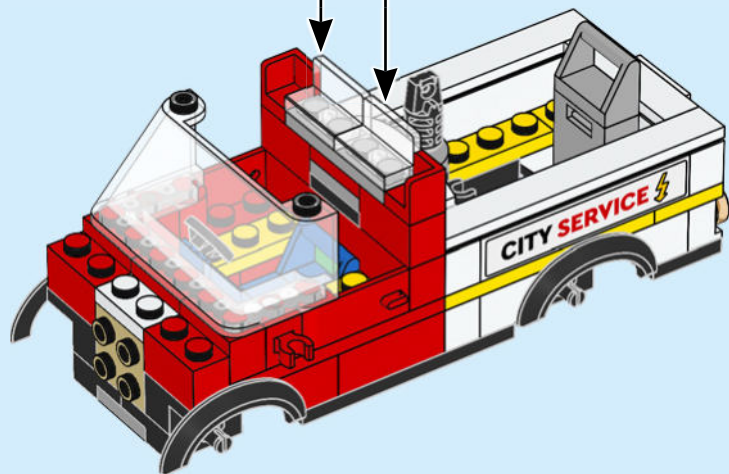

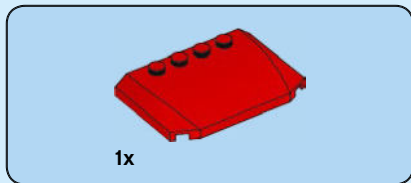

41

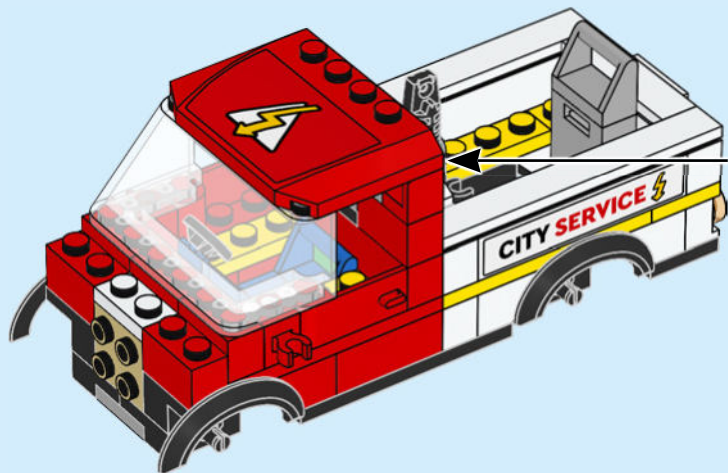
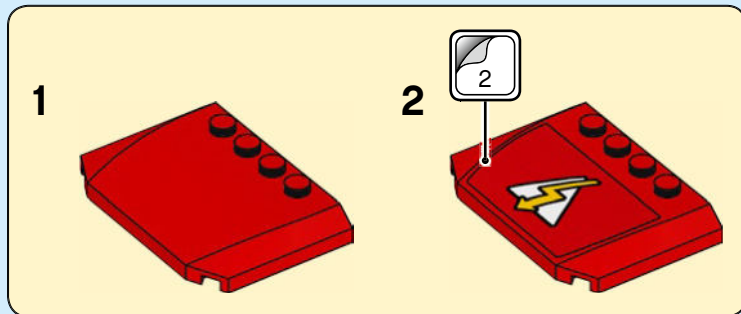



2x



1x



1x

42

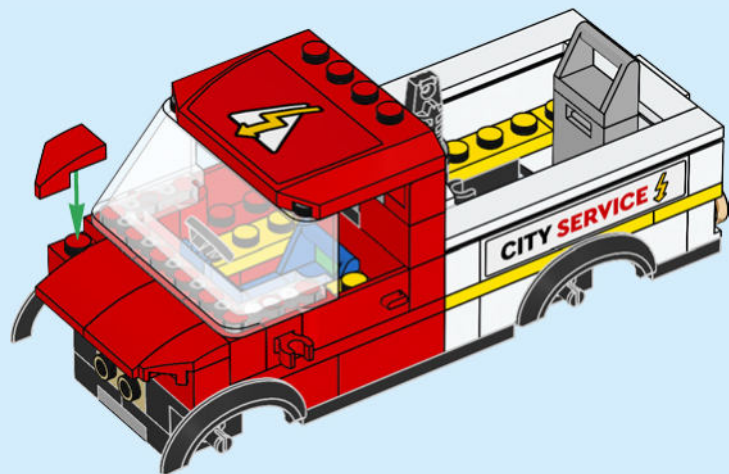

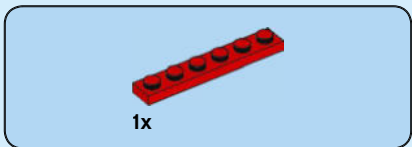

43

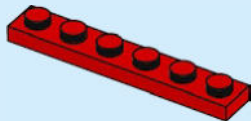

44

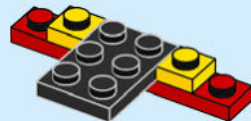



1x

45

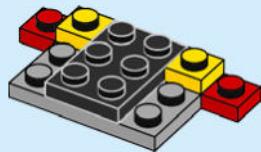

46



1x



2x

46

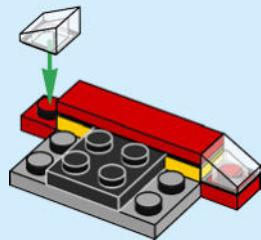



2x

47

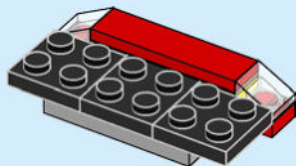

2x



2x

48

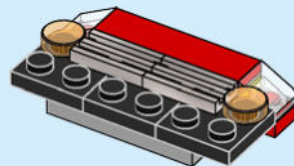



1x

49

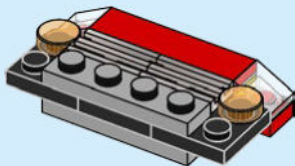

48



1x

50

1



2

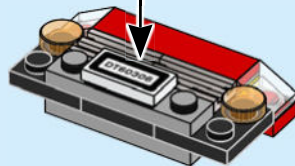



2x

51

1



2



1



2

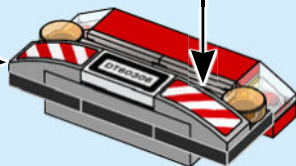

52





2x

53

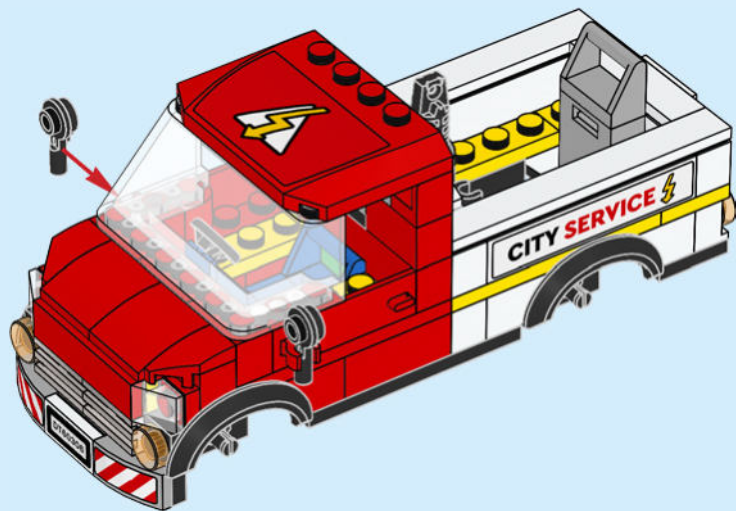

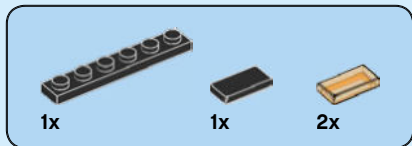

54

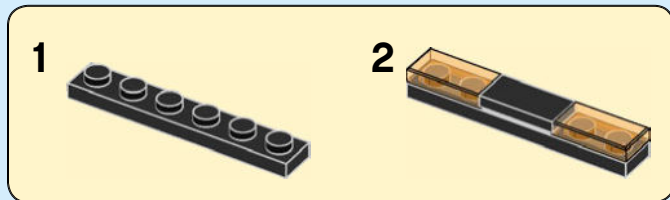



55

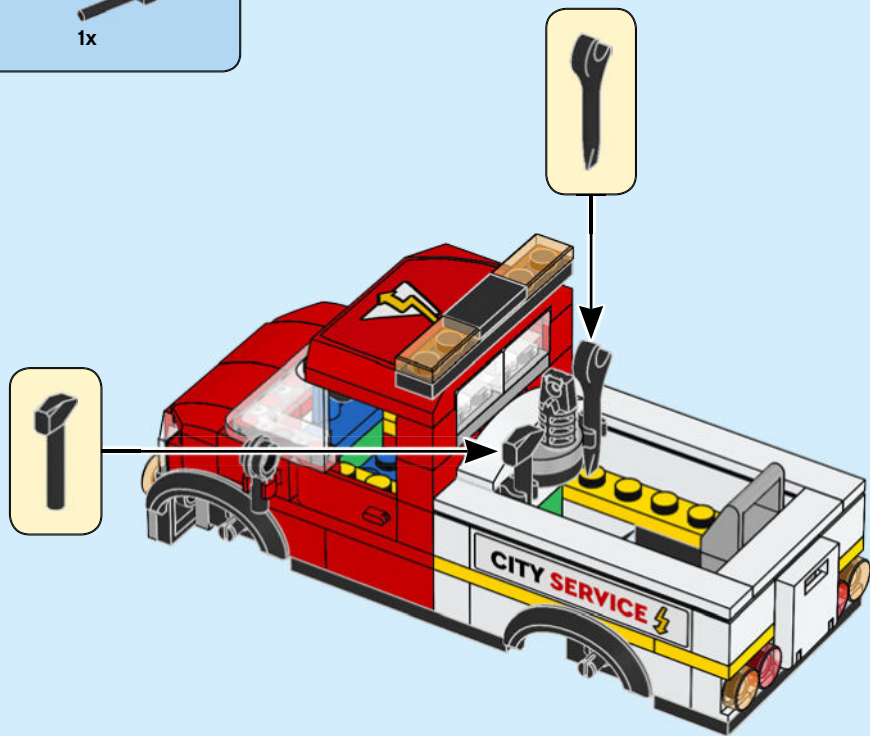

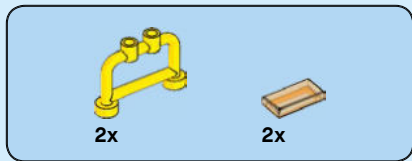

56

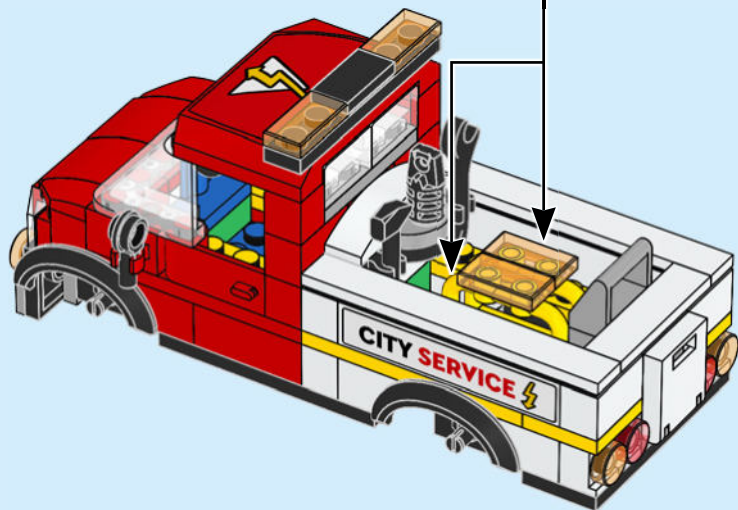
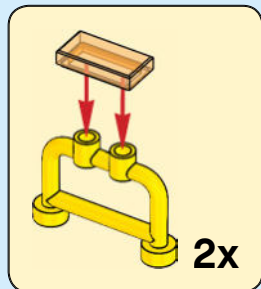



2x

57

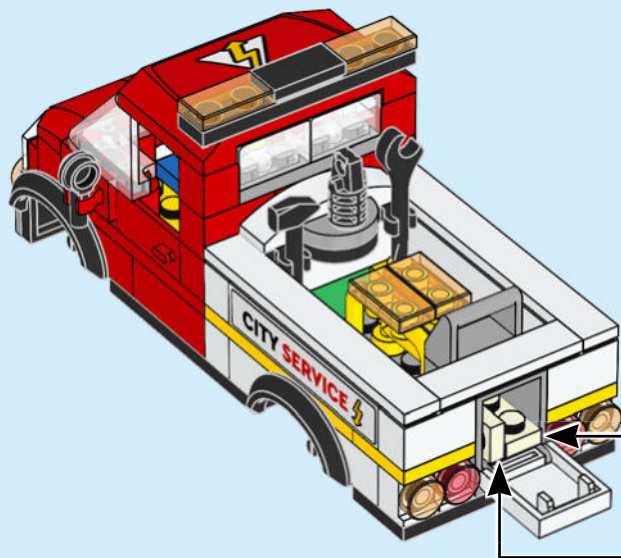

2x

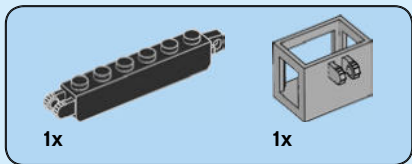

58

1

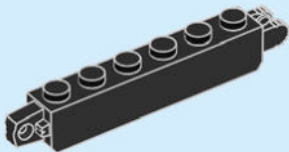

2

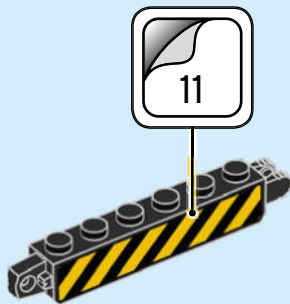



3



4

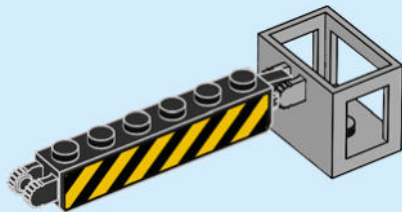

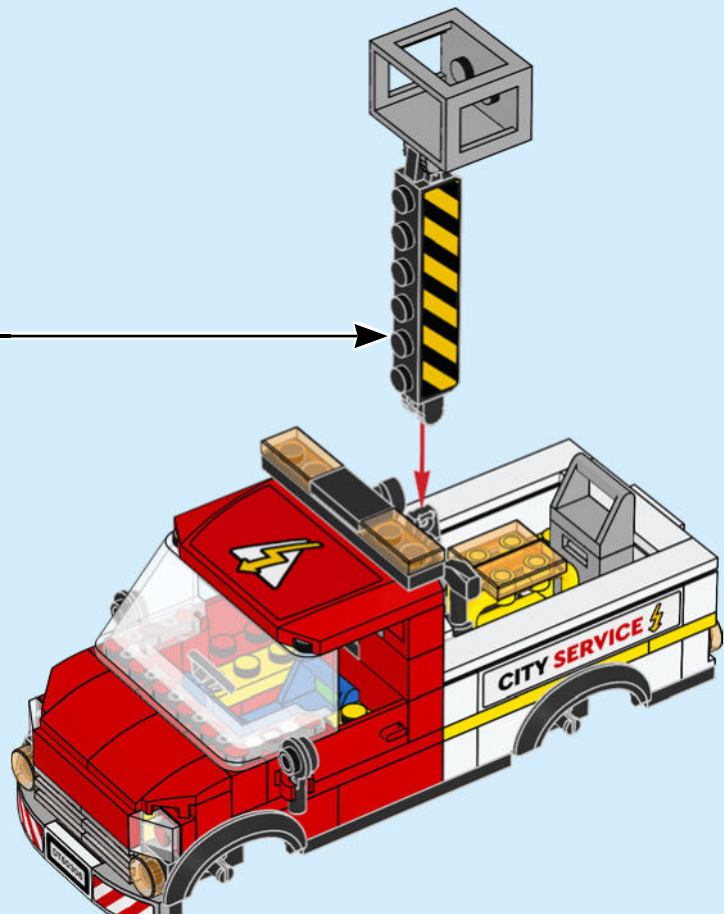



4x



4x

59

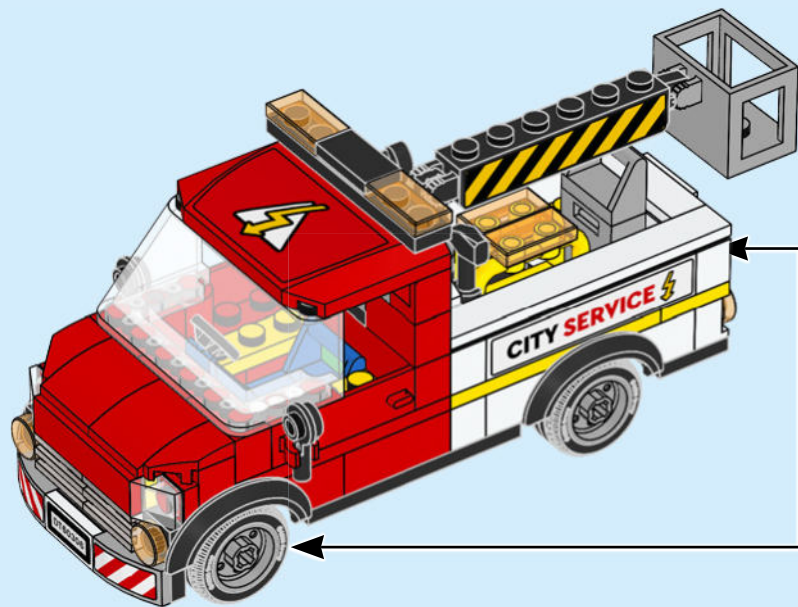

4x



CITY

CONNECT YOUR CITY

Connect your city
Verbinde deine Stadt
Connecte ta ville
Unisci la tua città
Conecta tu ciudad
Une a tua cidade
Bövitsd a város
Savieno savas
pilsētas daļas
连接你的城市



60292



60291



60290



60304