



# CITY

60292







- 1 Scan the code on the front cover  
 Scanne den Code auf der Titelseite  
 Scanne le code sur la page de couverture  
 Scanner le code sur la page couverture  
 Scansiona il codice sulla copertina  
 Escanea el código de la portada  
 Faz scan do código na frente da capa  
 Olvasd be a borítón látható kódot!  
 Noskenē kodu uz priekšējā vāka  
 扫描封面上的二维码



- 2 Get Instructions PLUS  
 Hol dir Instructions PLUS  
 Obtens les instructions PLUS  
 Obtenir les Instructions PLUS  
 Scarica Instructions PLUS  
 Descubre Instructions PLUS  
 Obtém Instruções PLUS  
 Szerezd be az Instructions PLUS  
 kiegészítőt!  
 Saņem "Instructions PLUS"  
 获取更多说明

**LEGO.com/apps**

Check for compatibility  
 Kompatibilität prüfen  
 Vérifier la compatibilité  
 Controlla la compatibilità  
 Comprueba tu compatibilidad

Verificar a compatibilidade  
 Ellenőrizd a kompatibilitást  
 Pārbaudīt saderību  
 检查兼容性



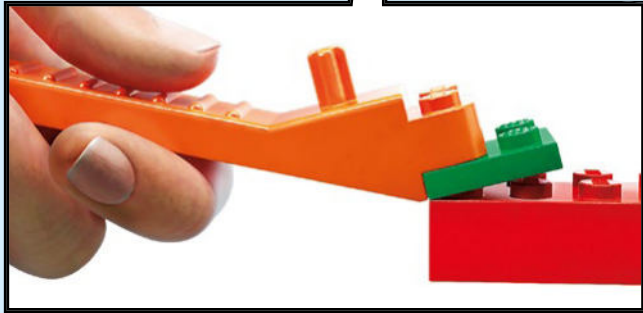
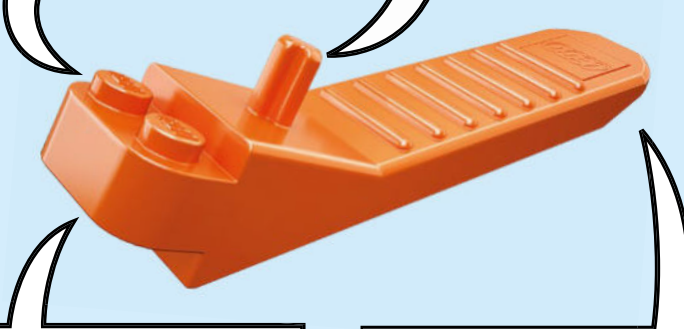
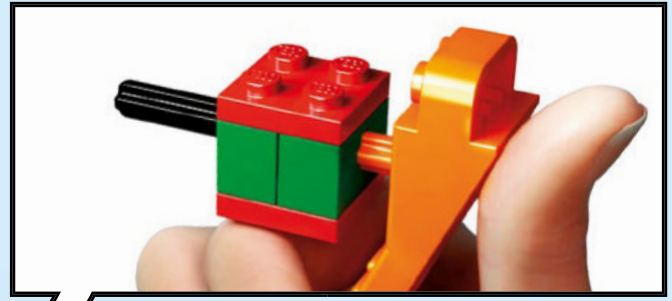
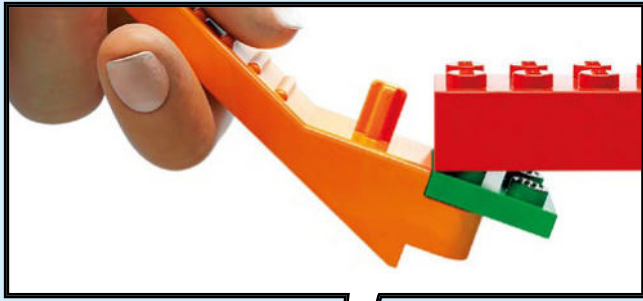

[LEGO.com/brickseparator](https://LEGO.com/brickseparator)



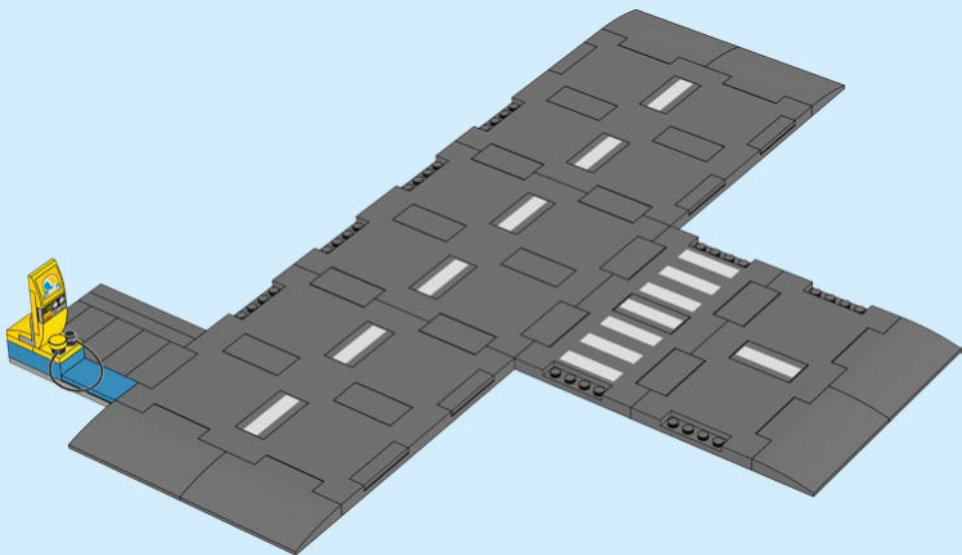
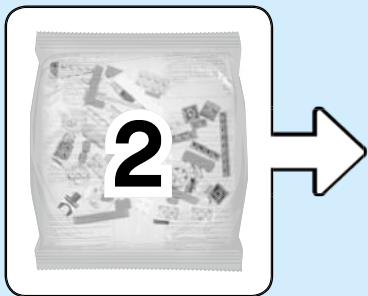
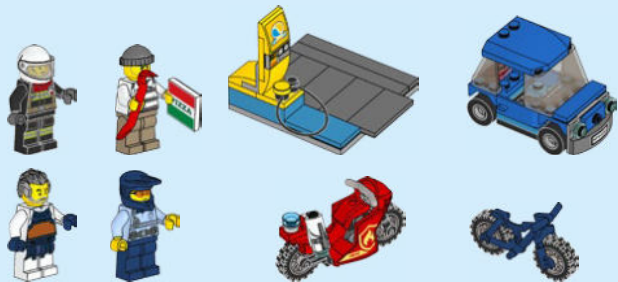
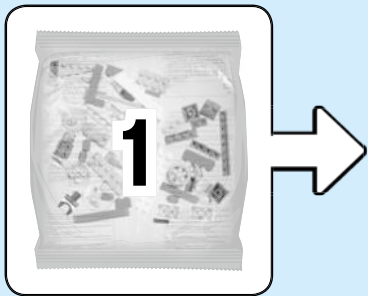

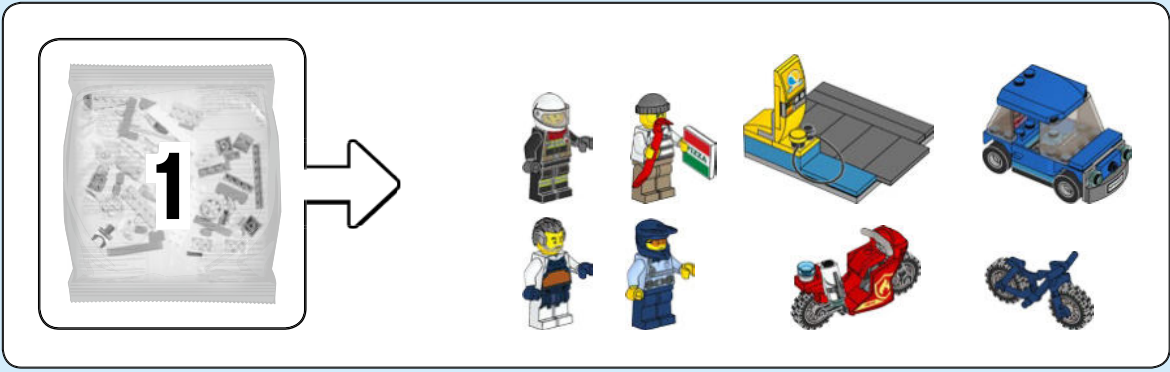

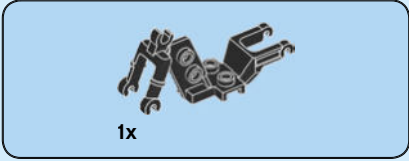

1

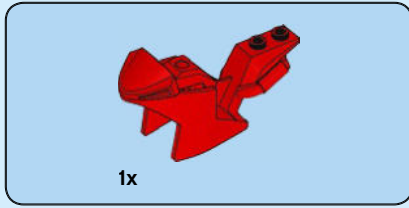
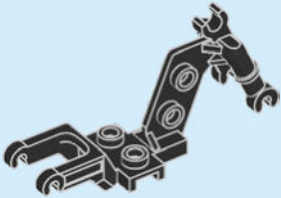

2

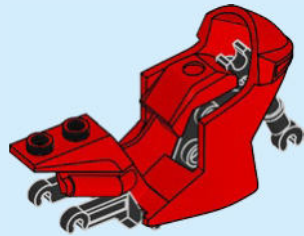



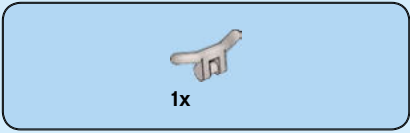

3

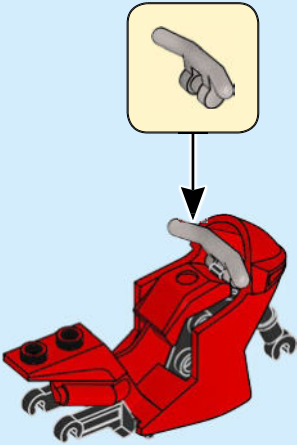

4



# 5

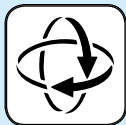

# 6

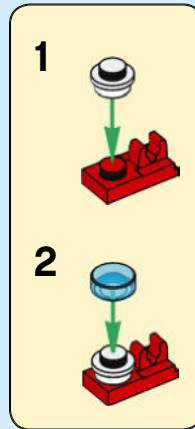
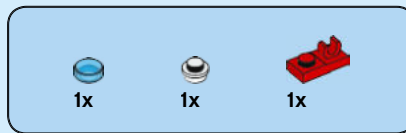
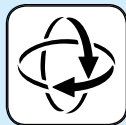

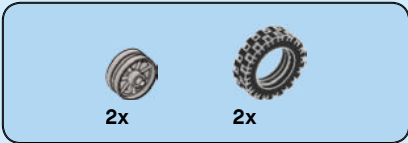

7

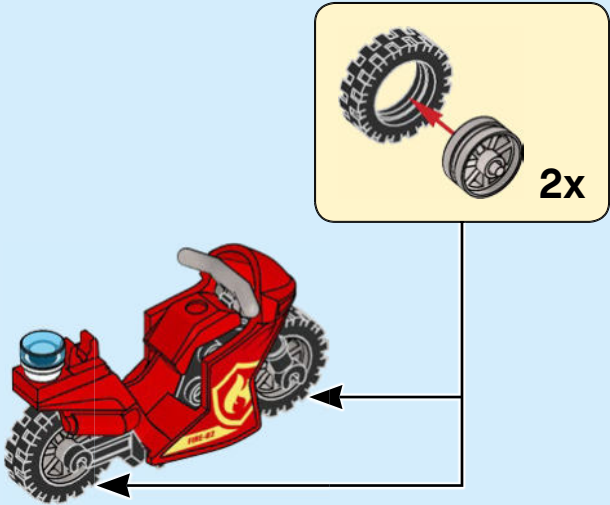



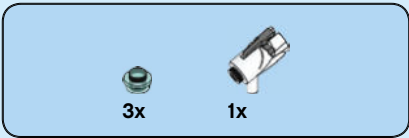

8

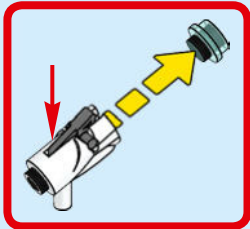
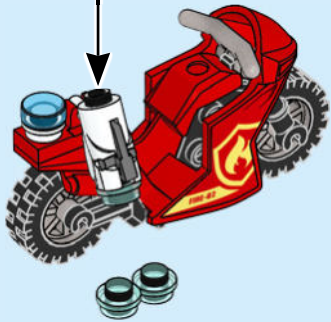
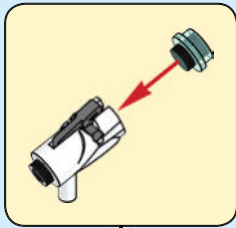

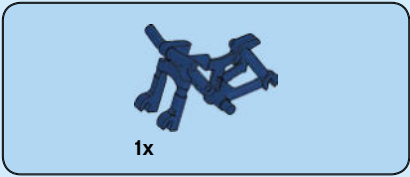

1

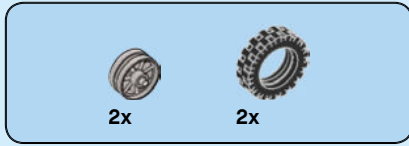

2

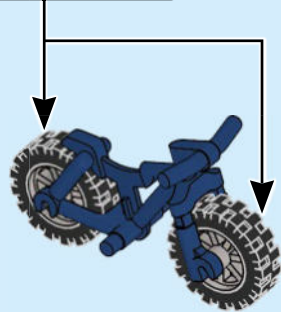





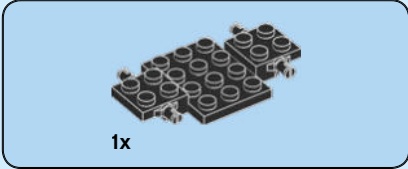

1

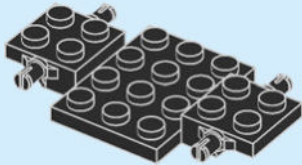

2

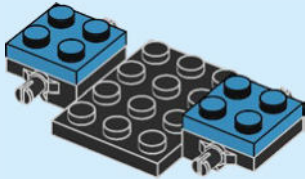

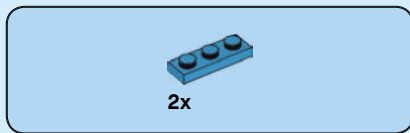

3

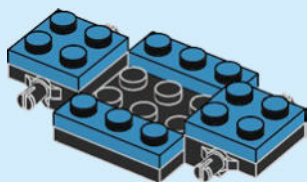

4

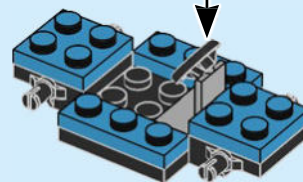

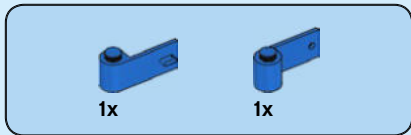

5

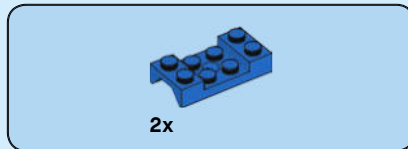
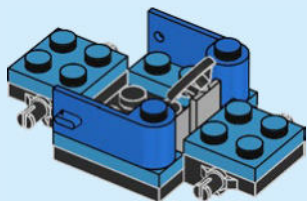

6

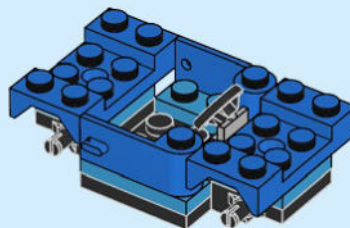

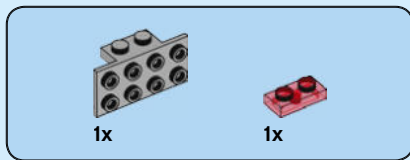

7

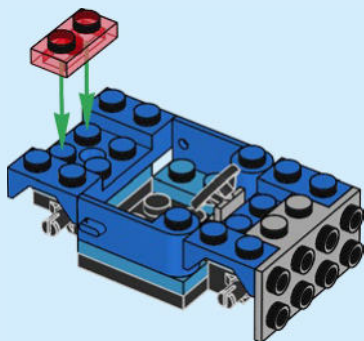

8

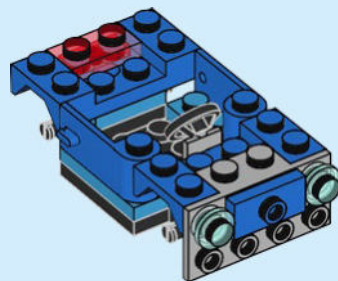



9

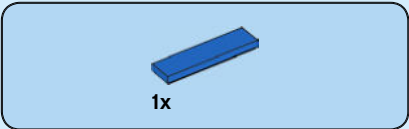
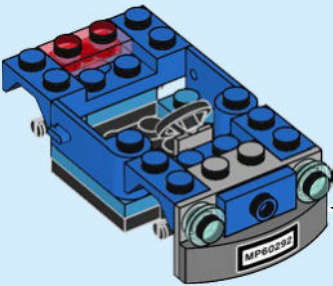
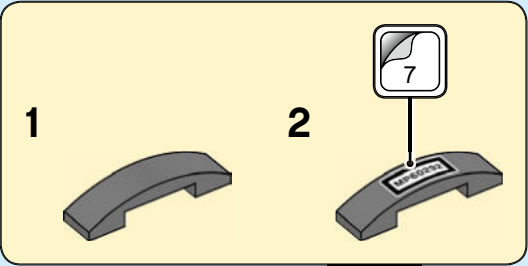

10

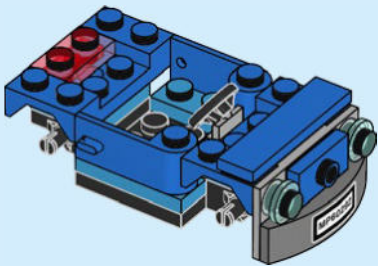



11

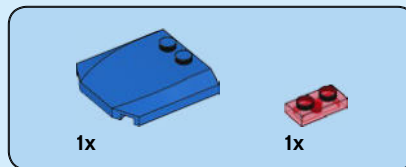
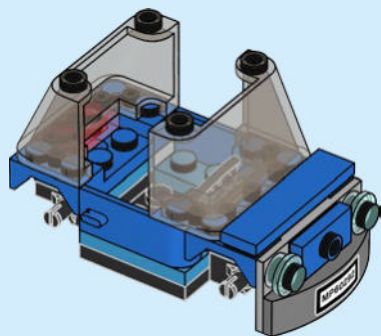

12

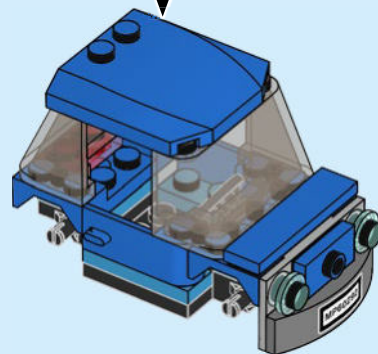
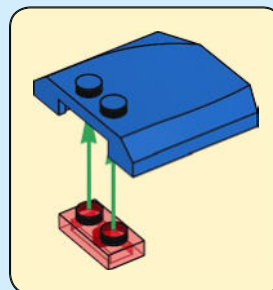

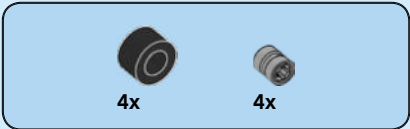

# 13

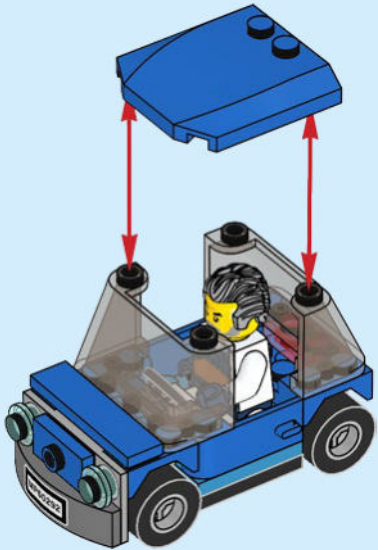
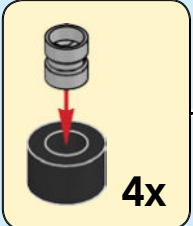
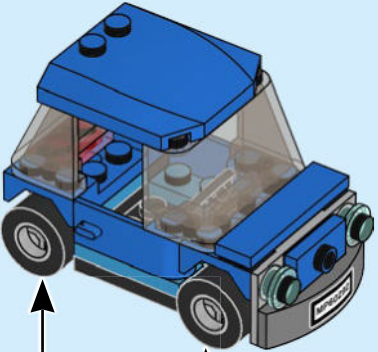



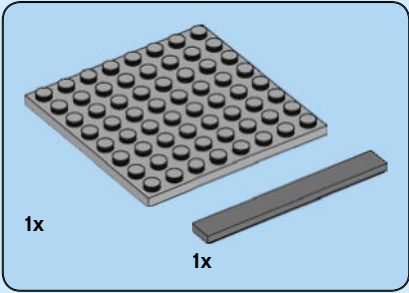

**1**

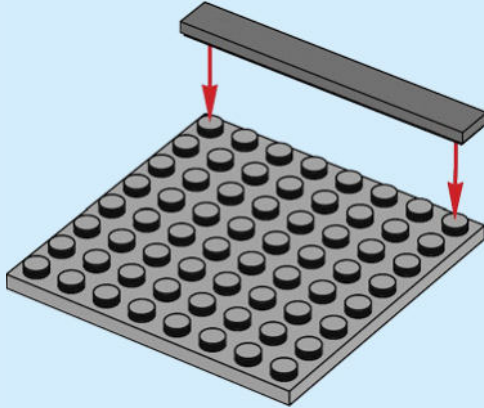

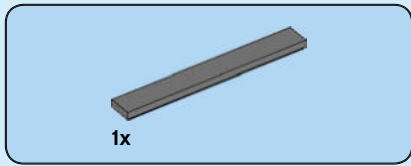

**2**

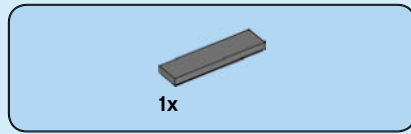
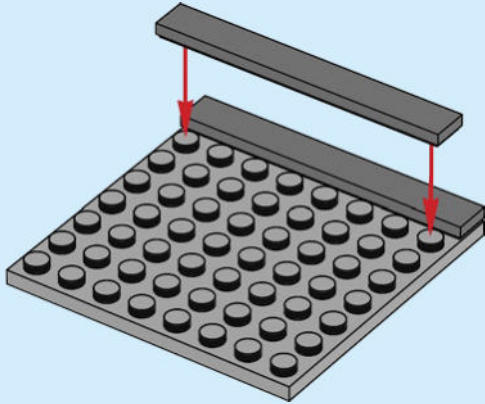

**3**

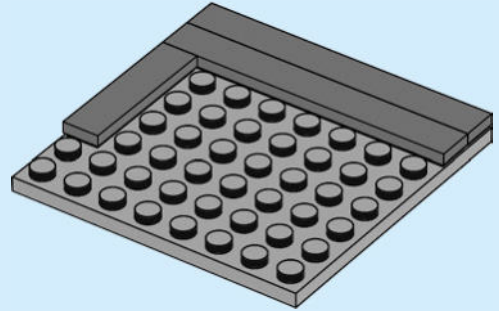

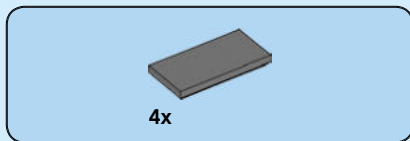

4

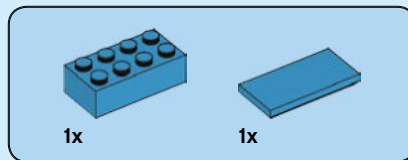
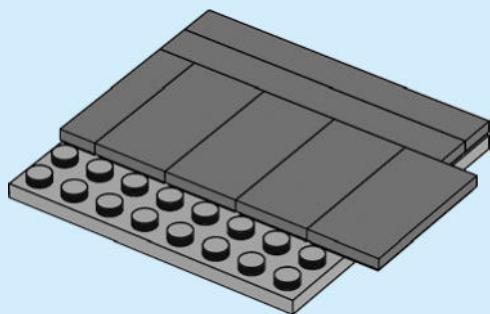

5

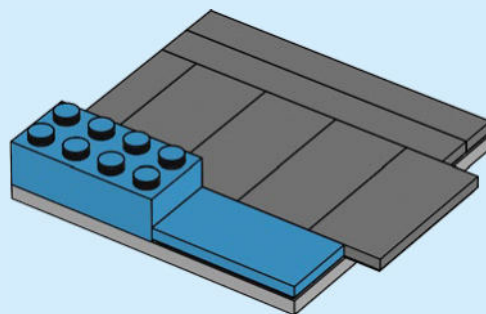



1x



1x

6

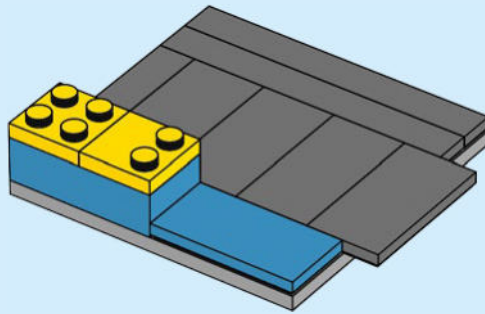



1x

7

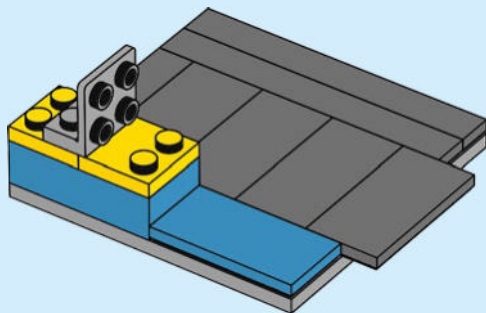

1x

8

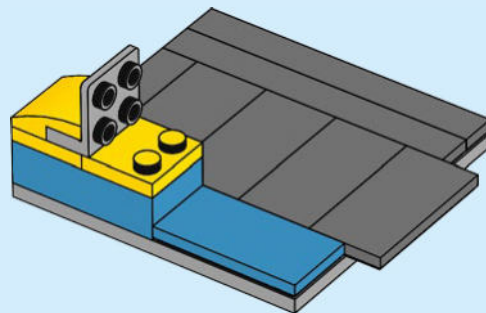

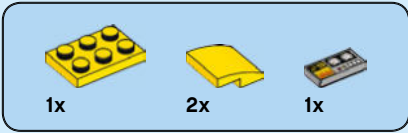

# 9

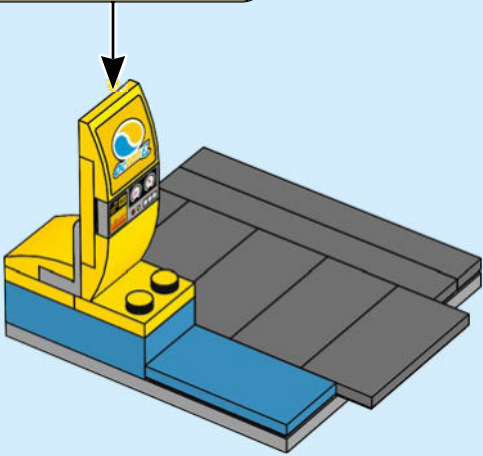
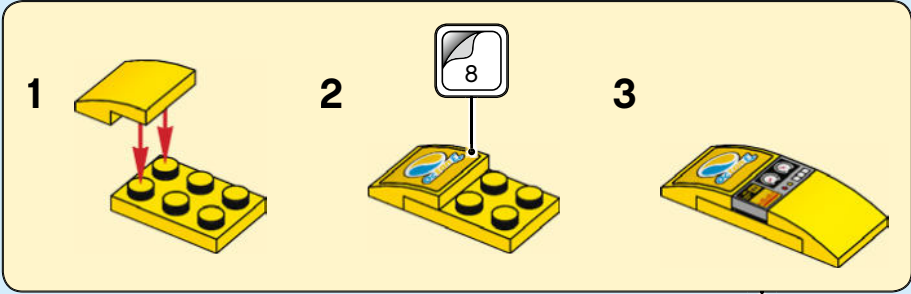

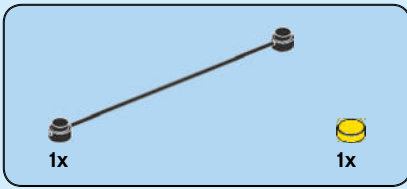

10

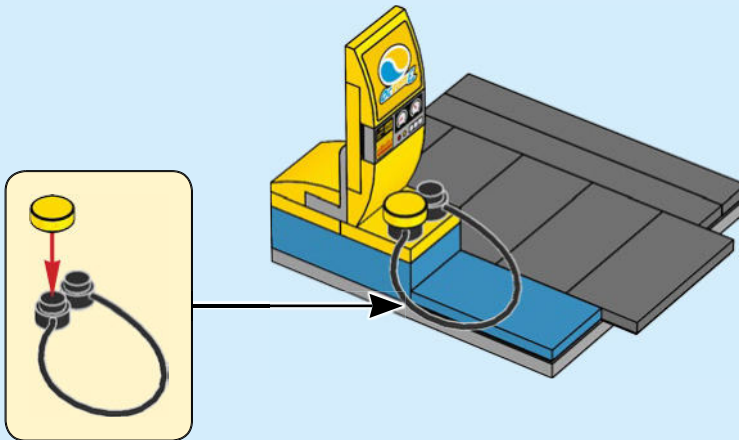



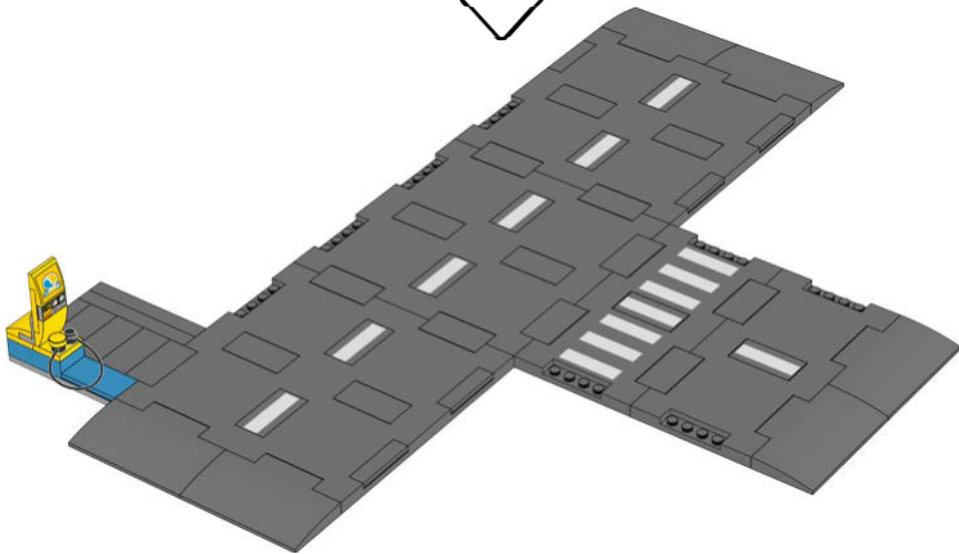
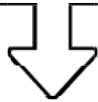
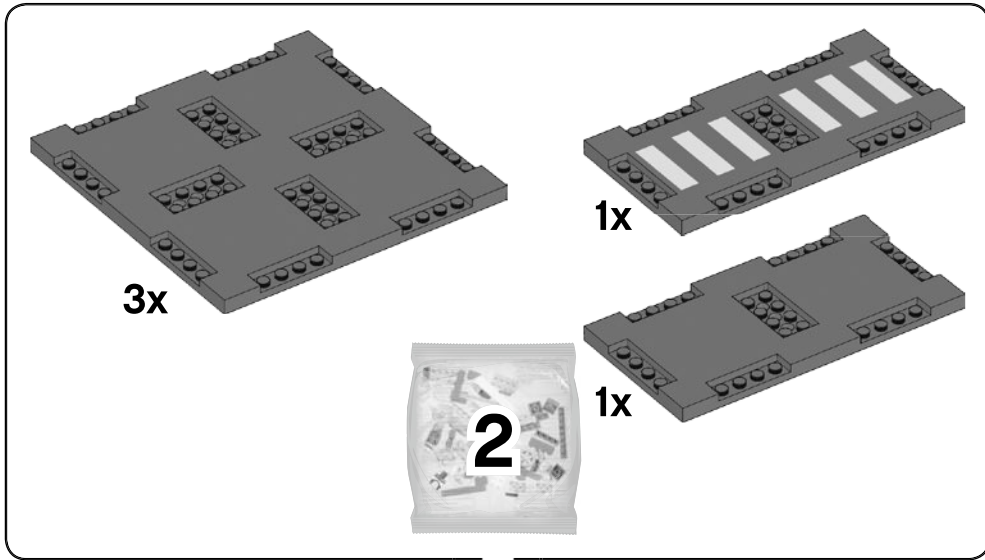

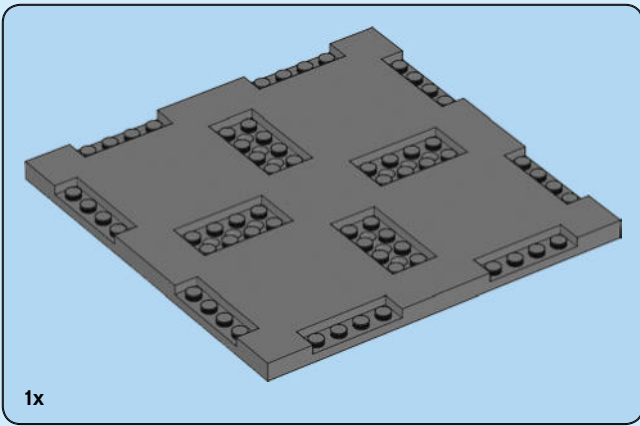

1

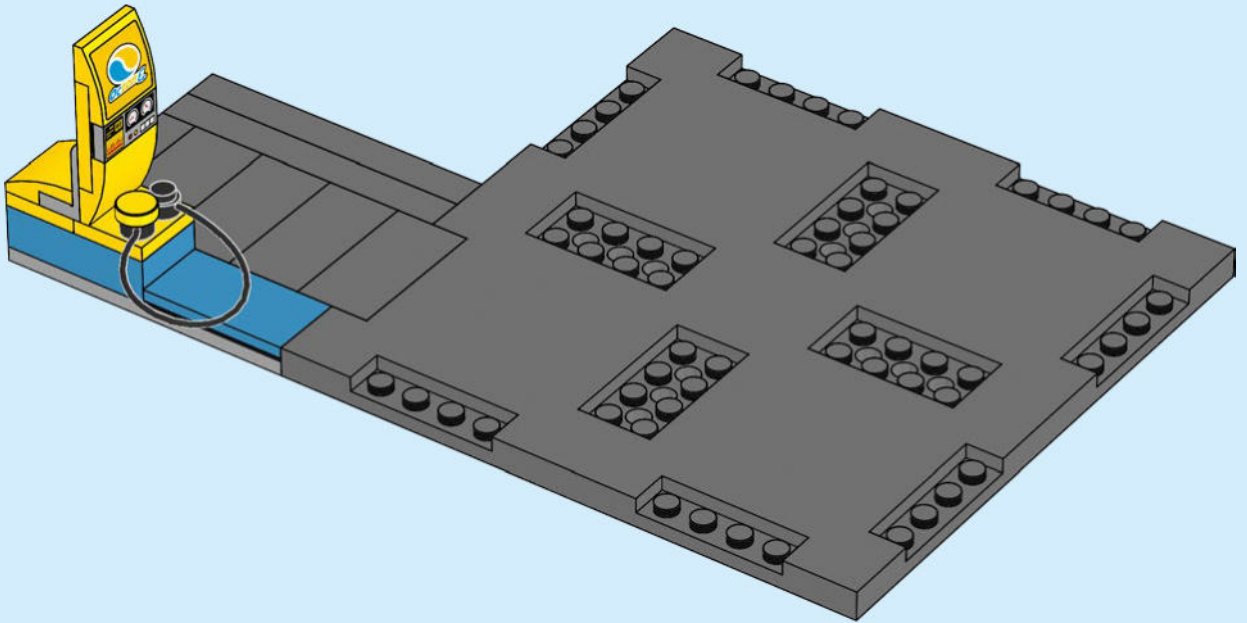

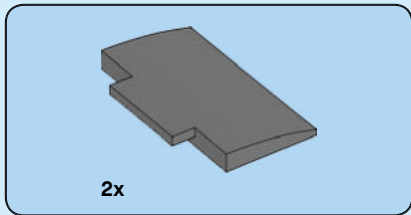

2

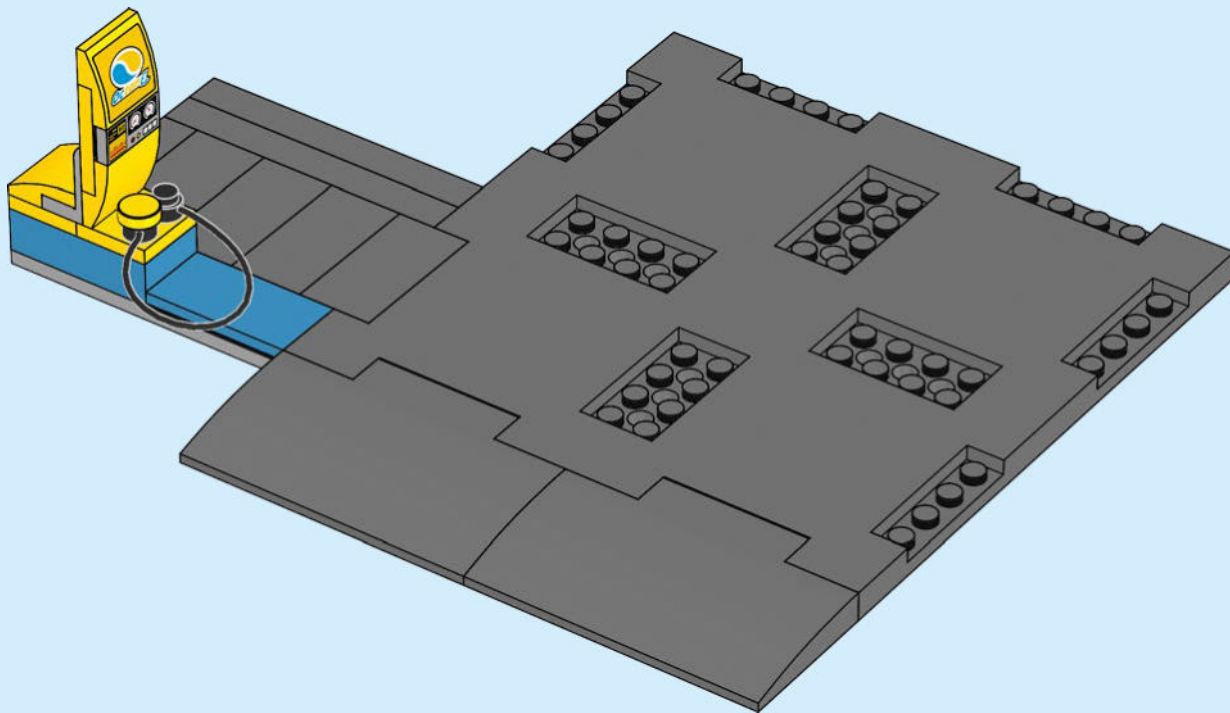

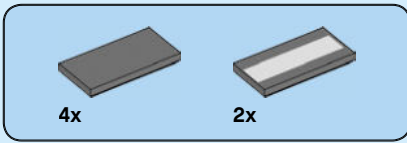

**3**

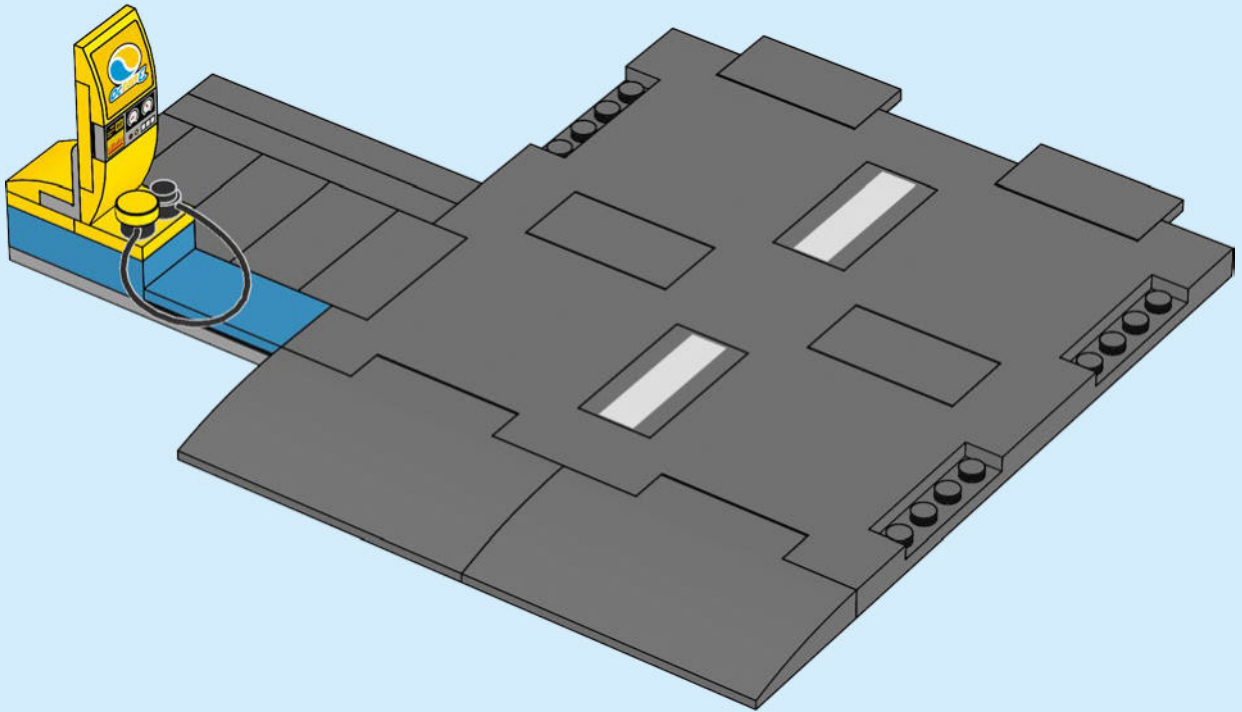

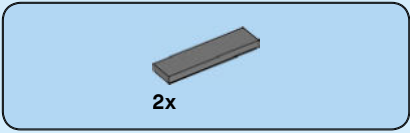

4

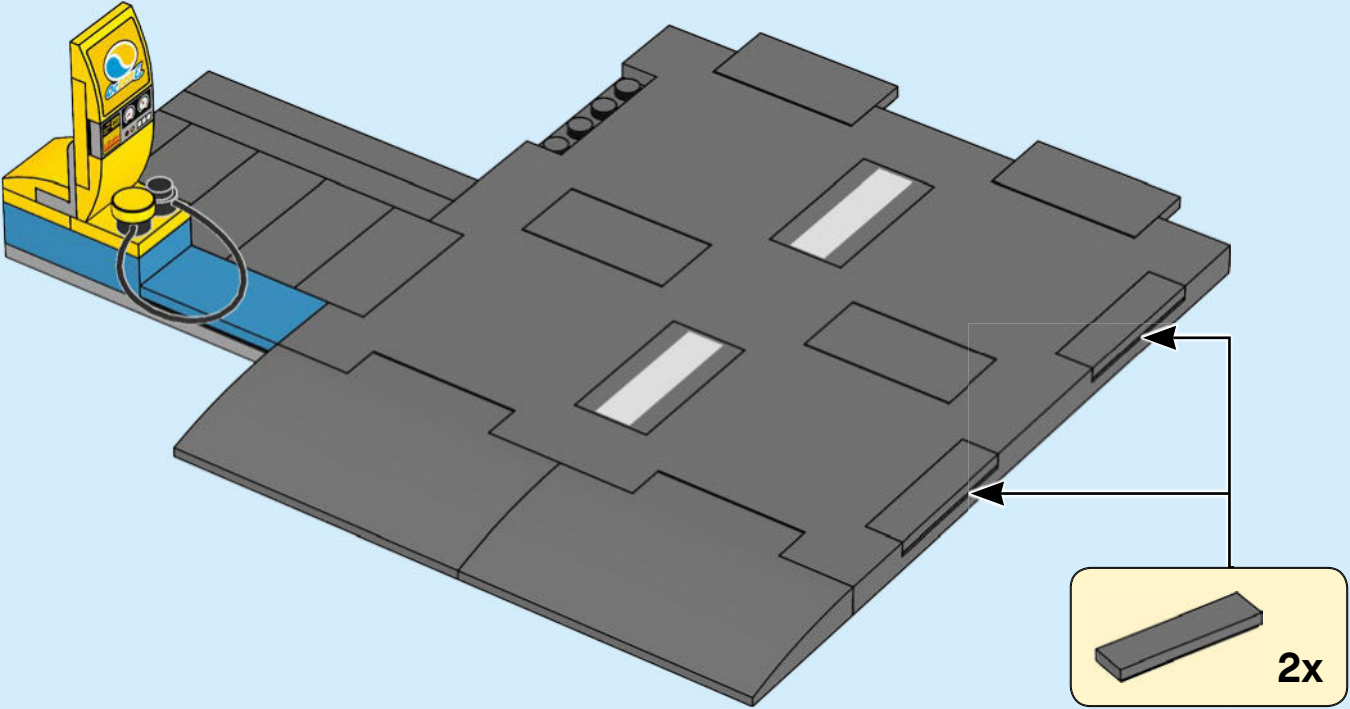

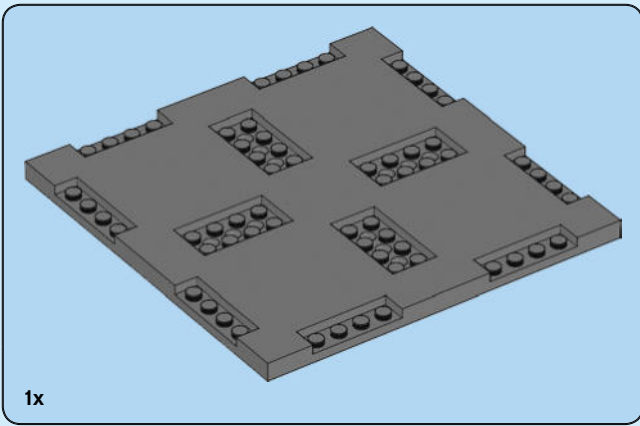

1x

**5**

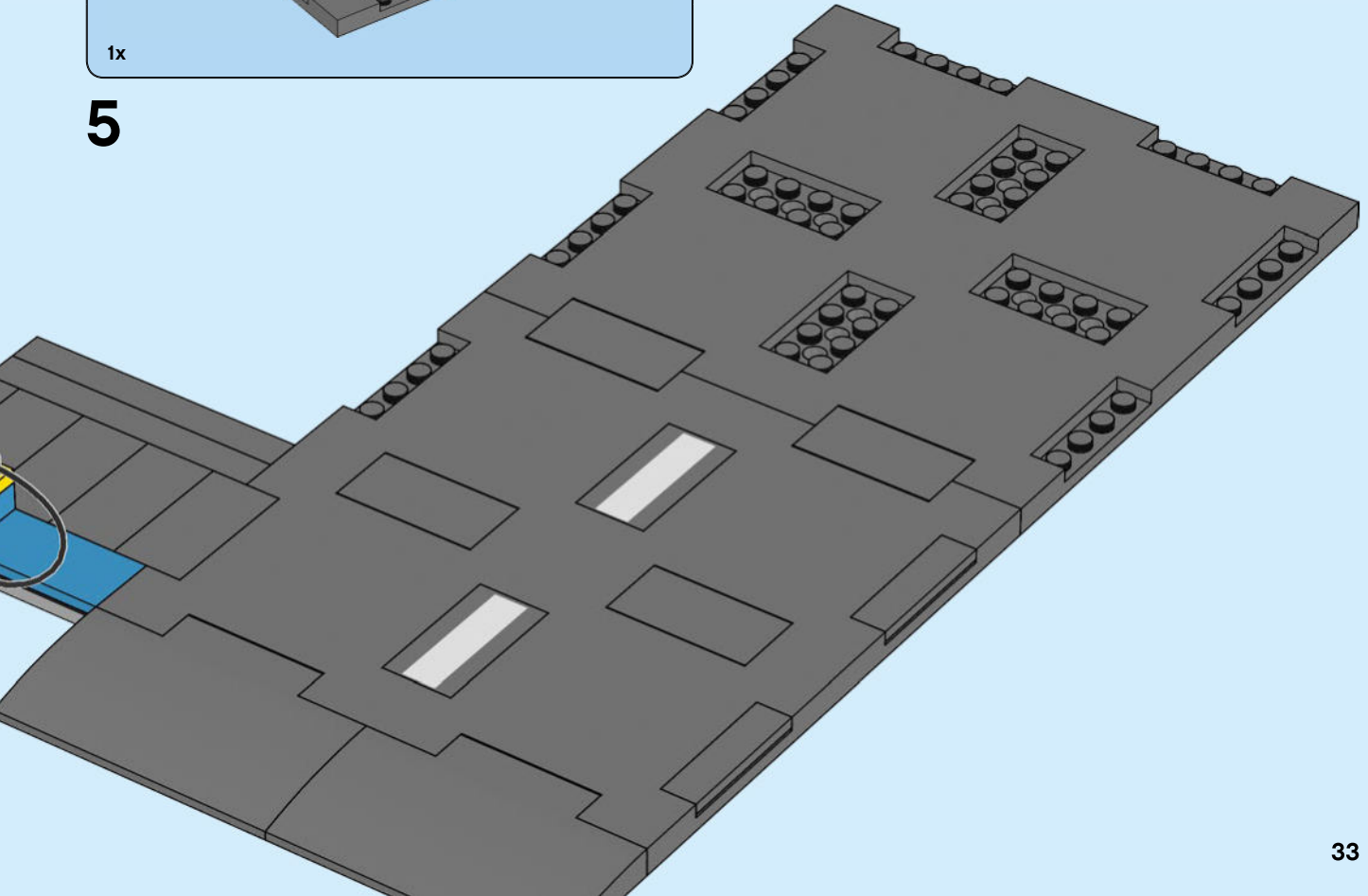

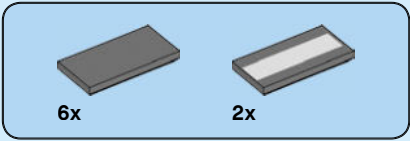

6

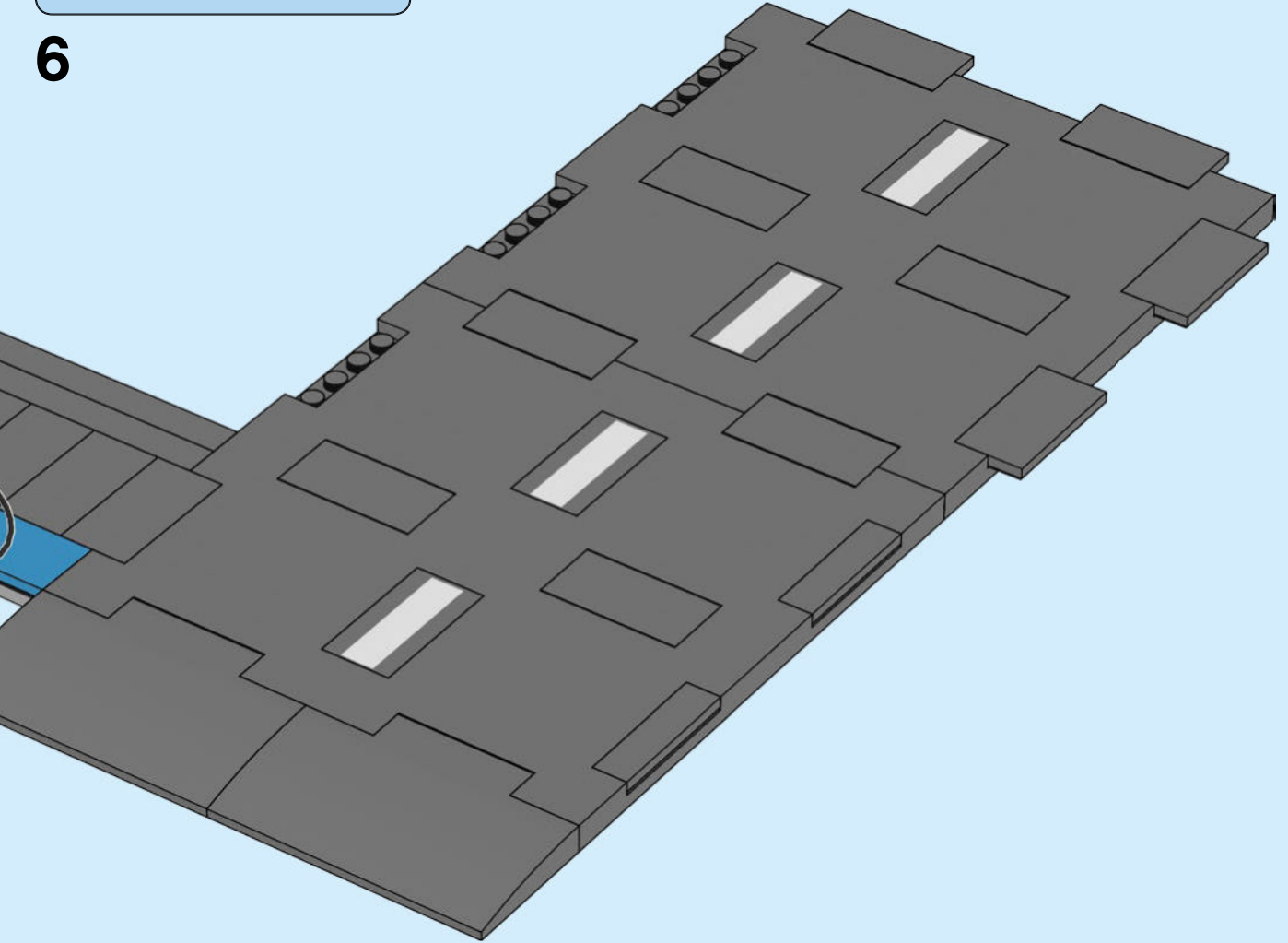



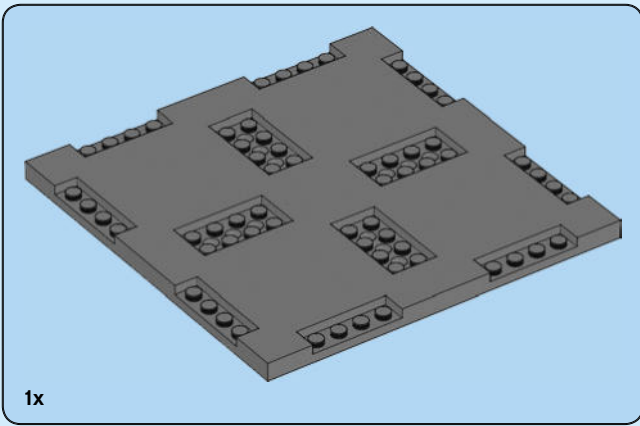

1x

7

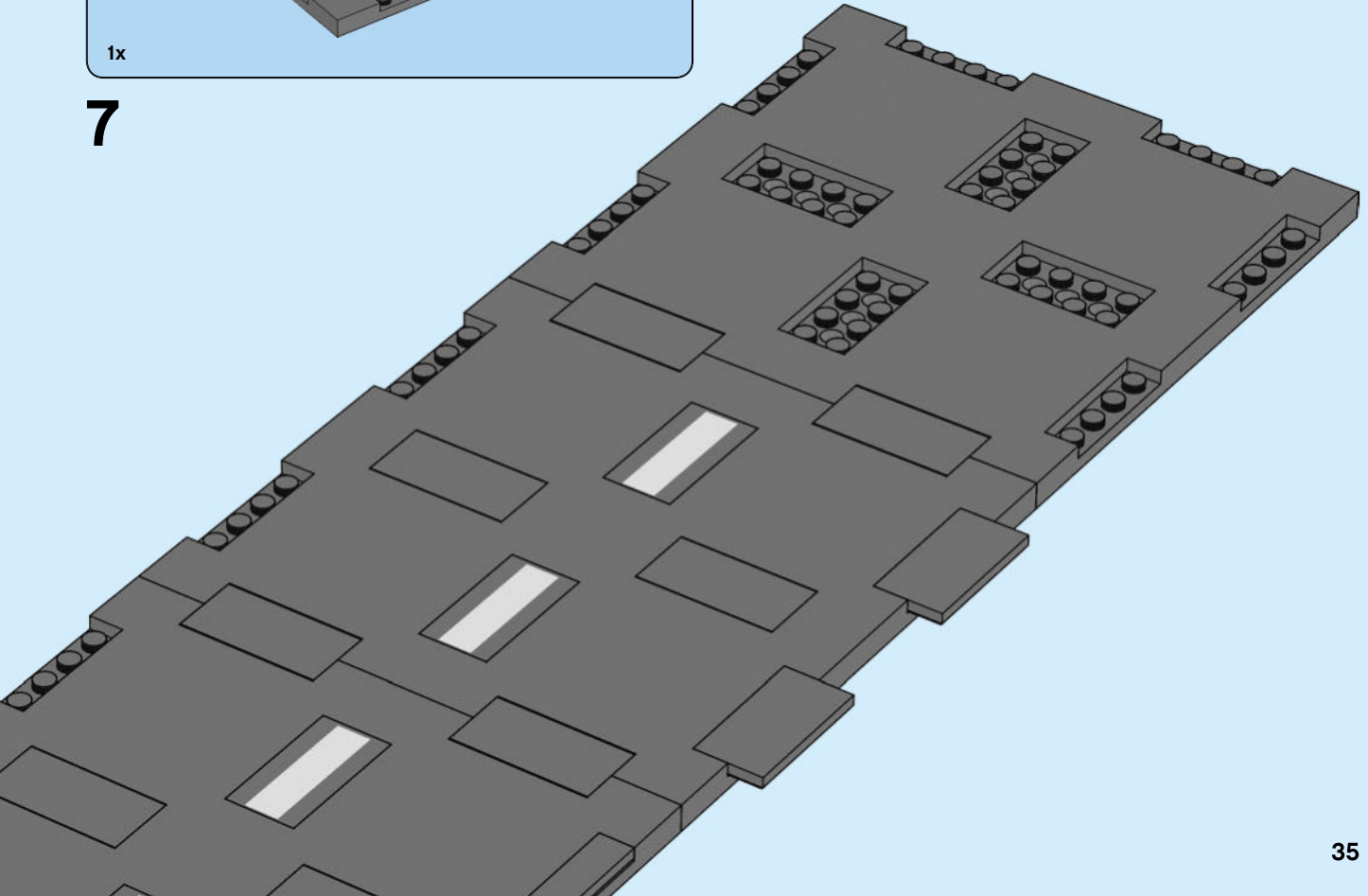

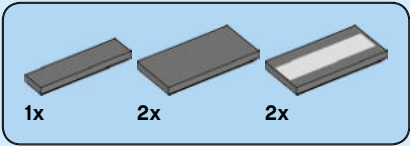

8

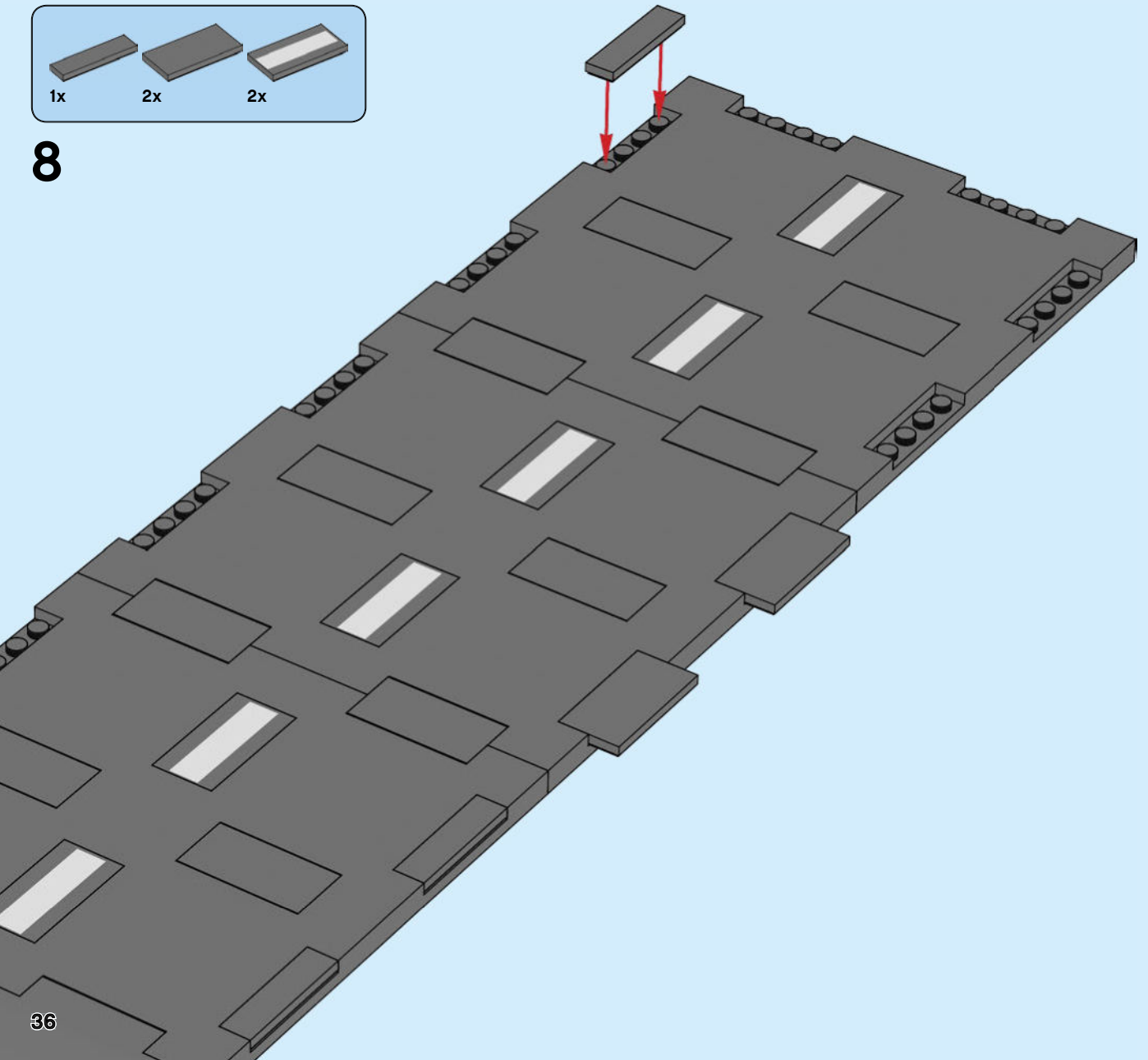

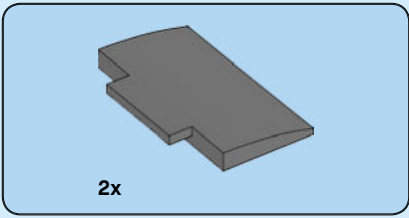

9

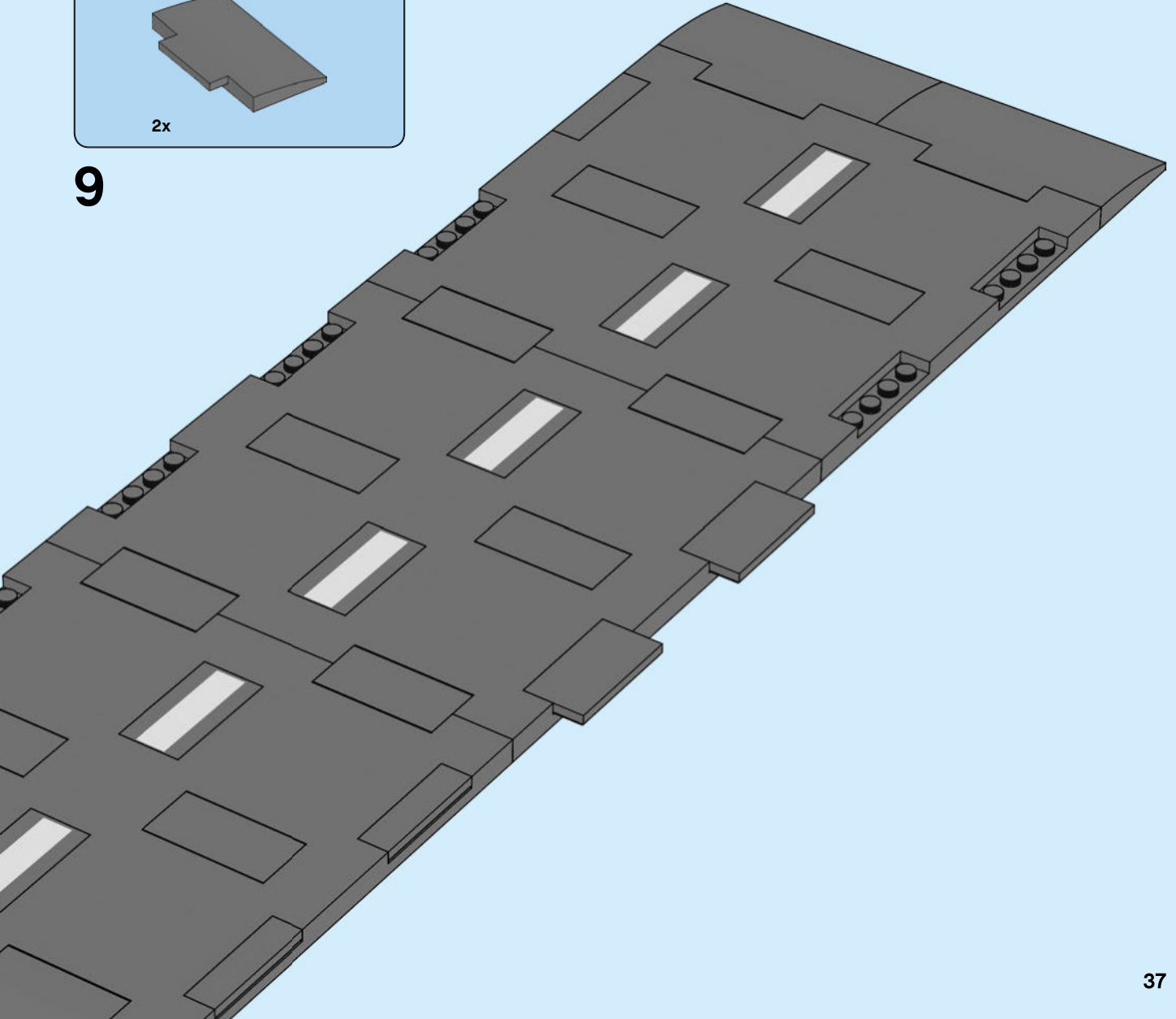

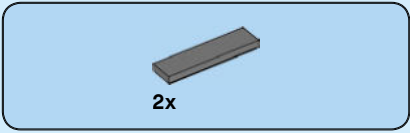

10

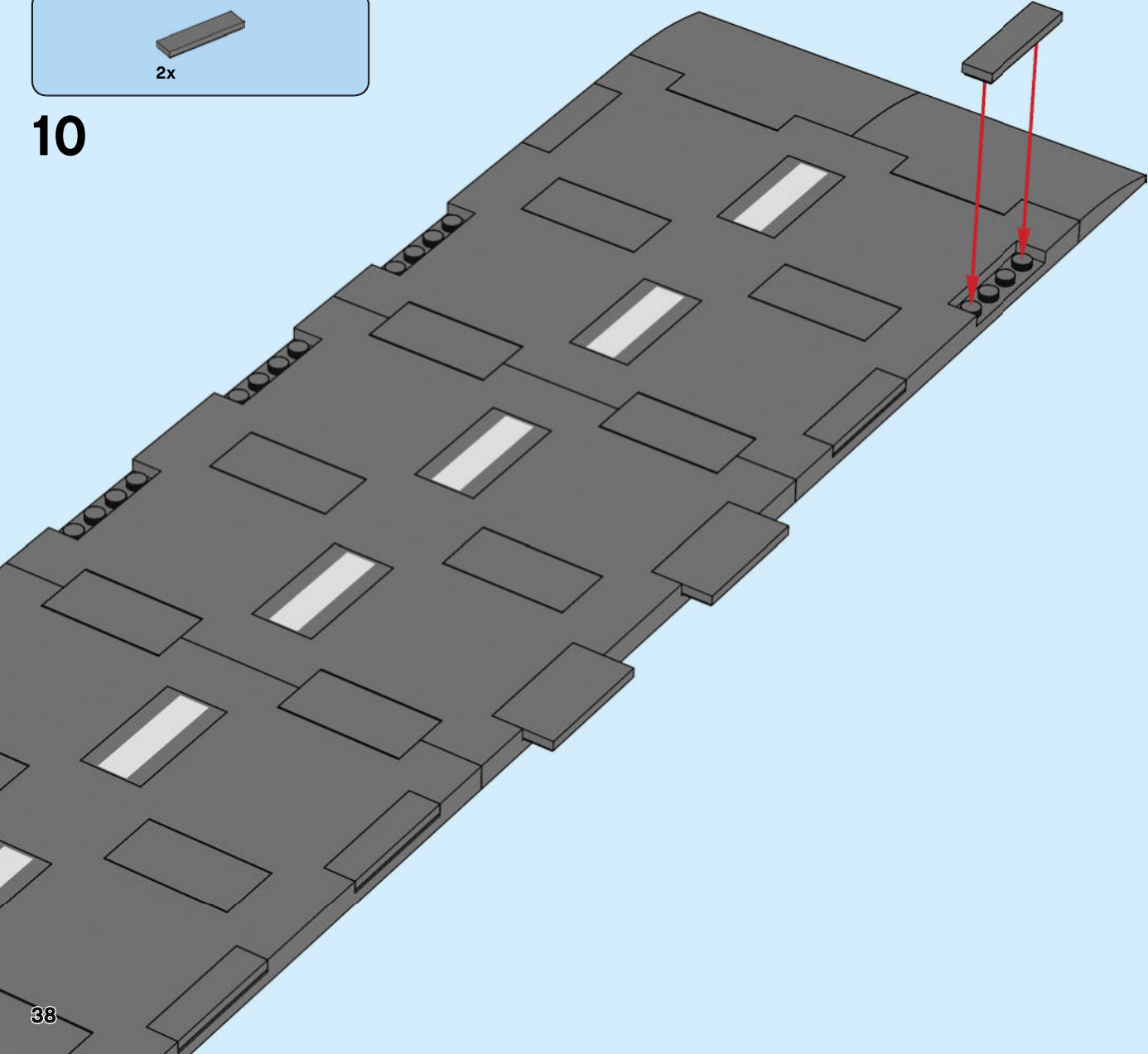

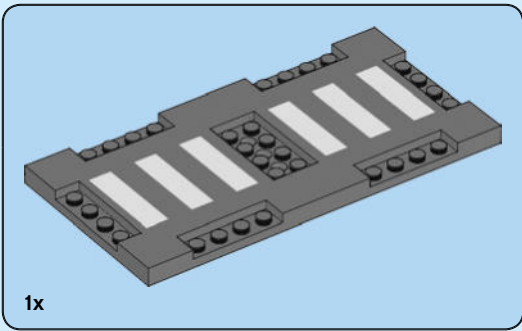

11

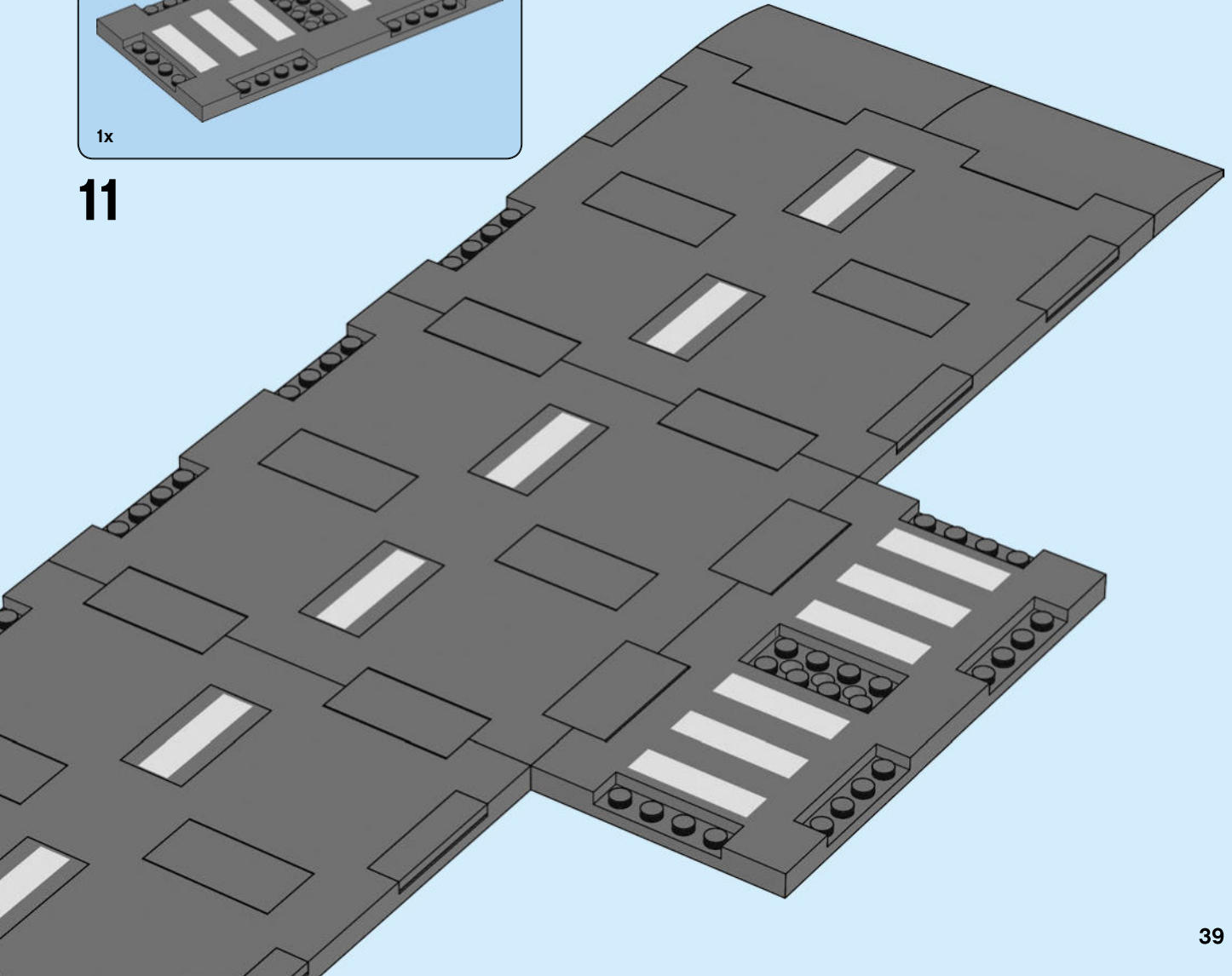

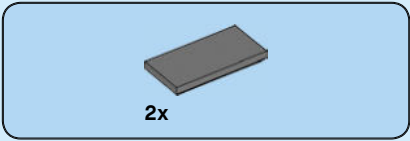

12

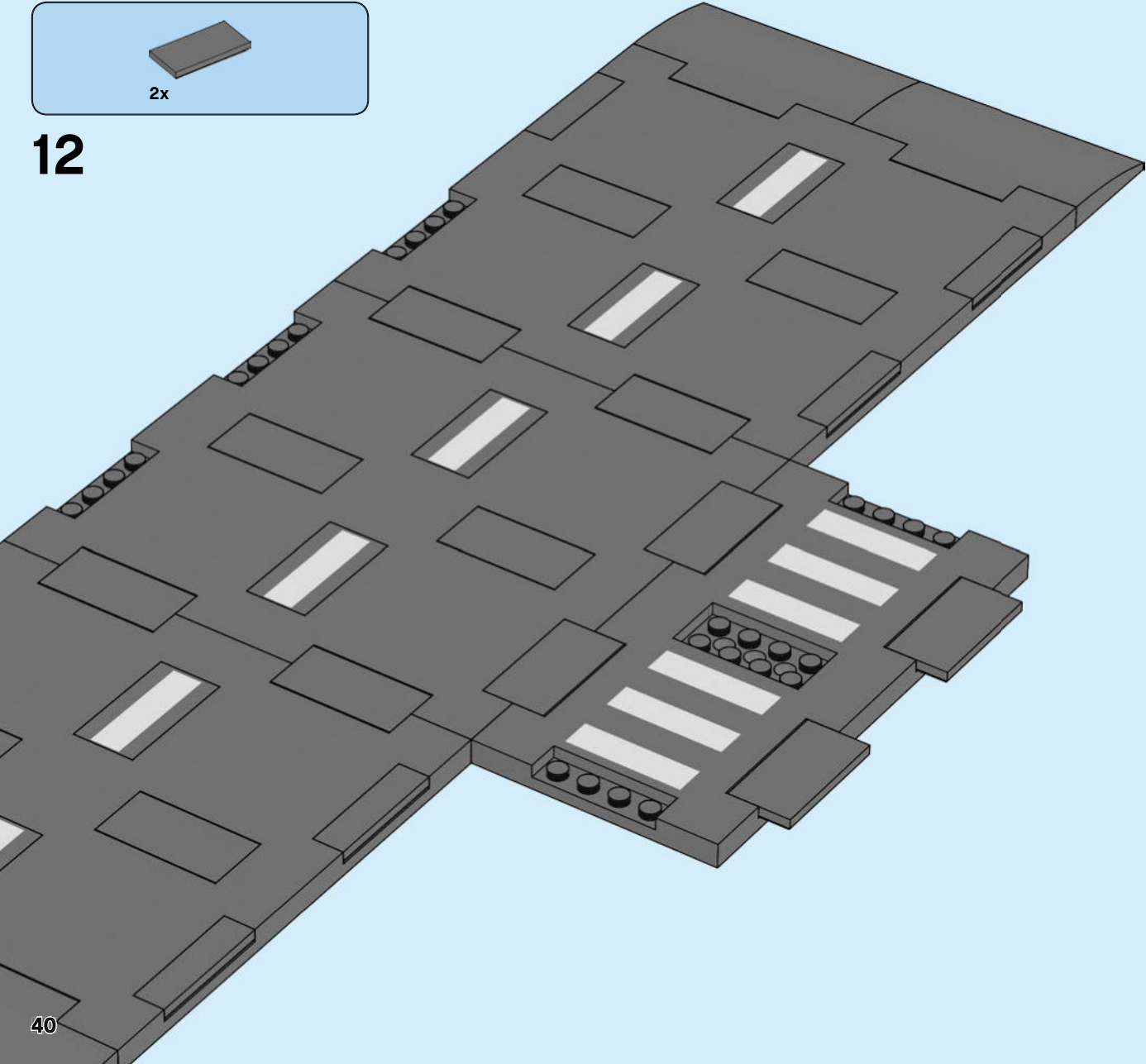

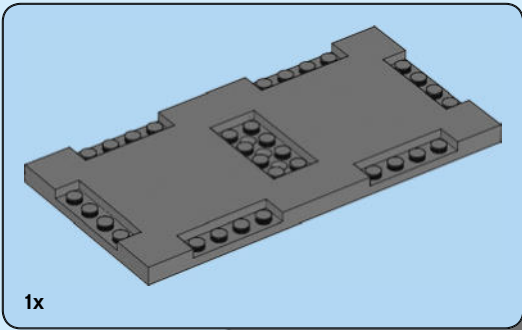

13

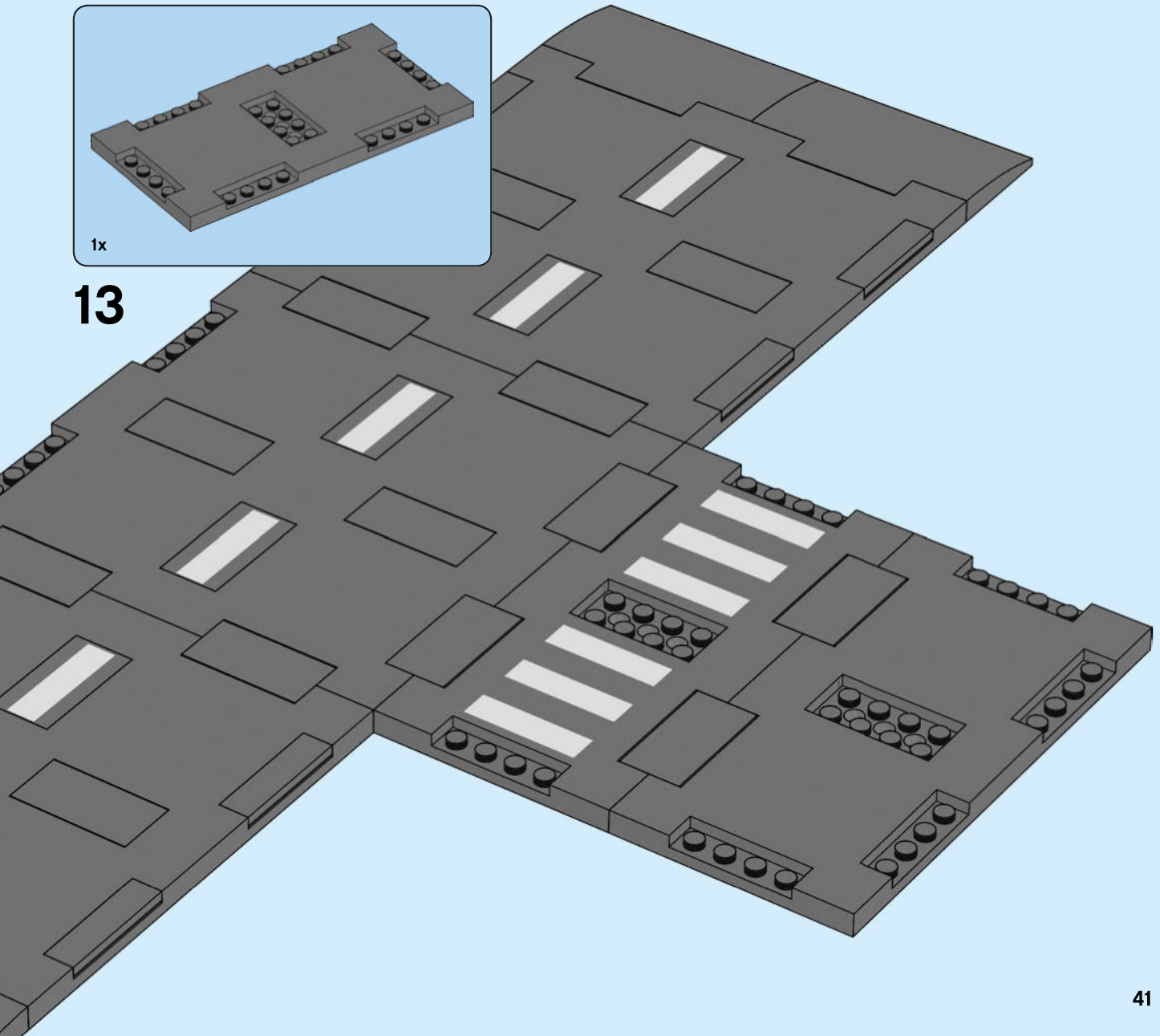



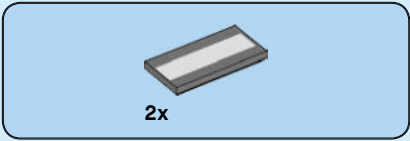

14

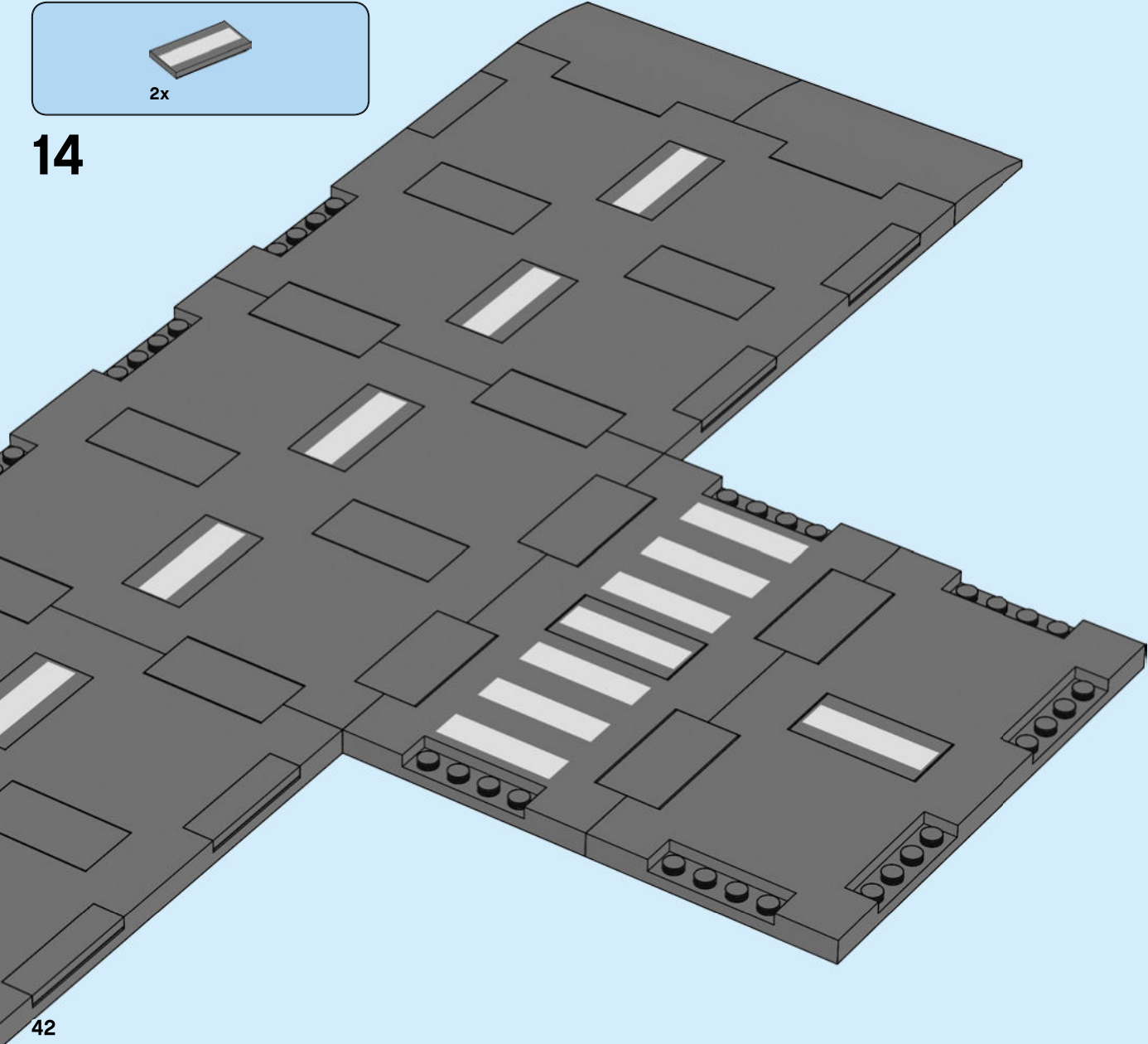

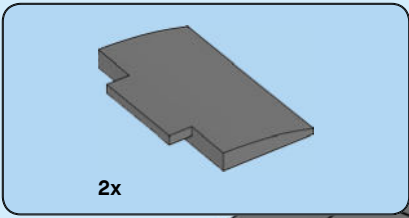

15

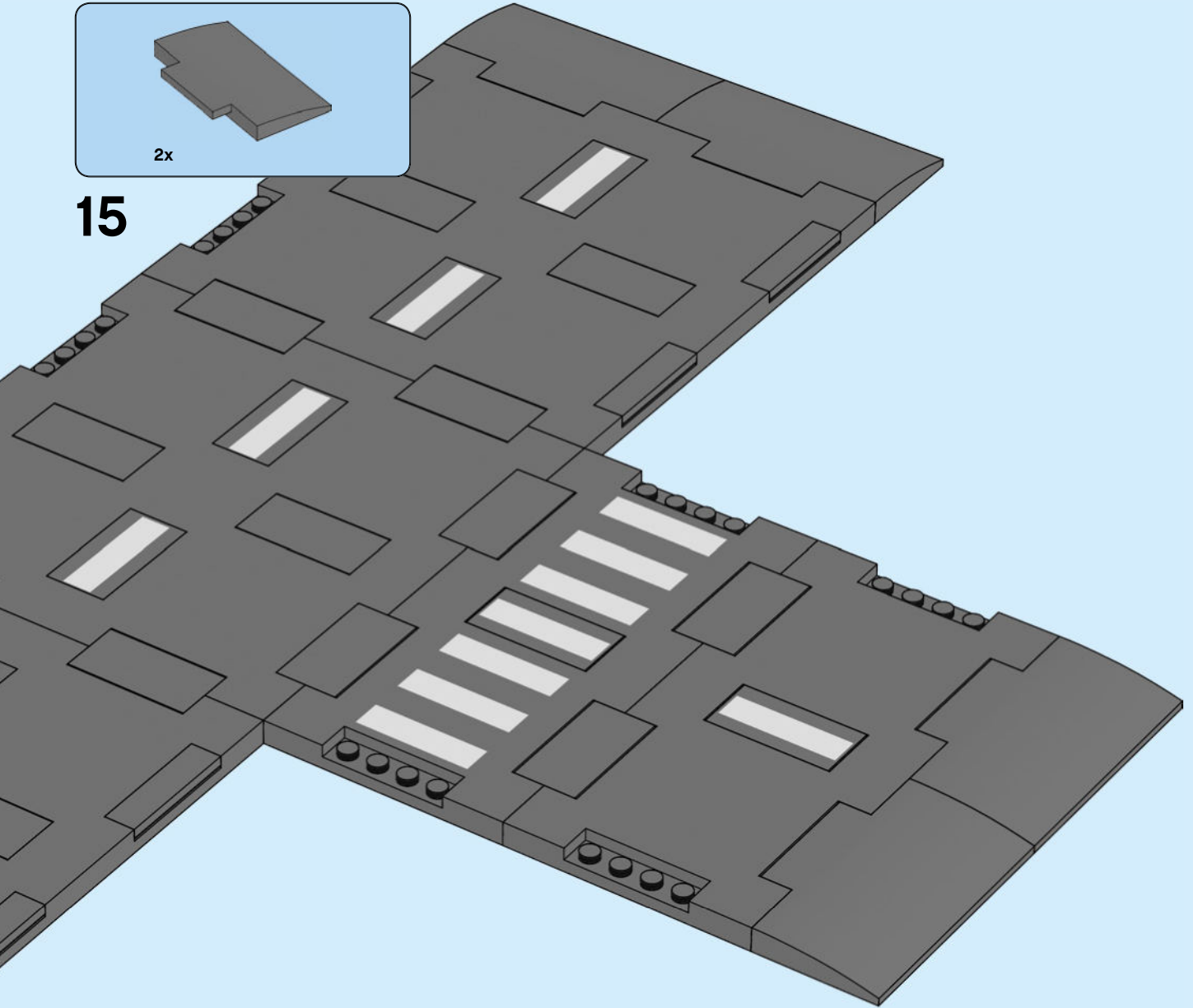



# CITY

Connect your city  
Verbinde deine Stadt  
Connecte ta ville  
Unisci la tua città  
Conecta tu ciudad  
Une a tua cidade  
Bővítsd a várost  
Saviēno savas pilsētas daļas  
连接你的城市



60292

+



60291

+



60290

+



60304

# CONNECT YOUR CITY







# CITY

60292



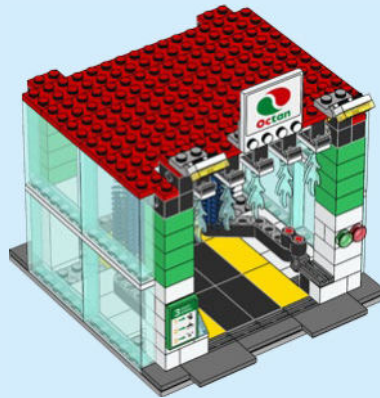
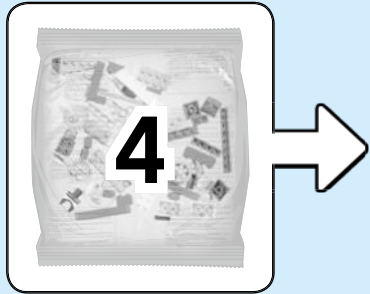
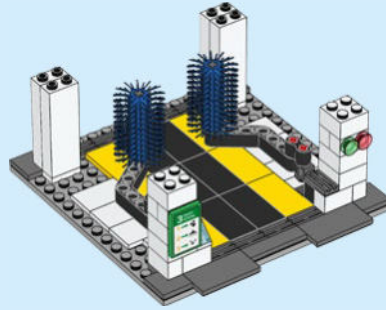
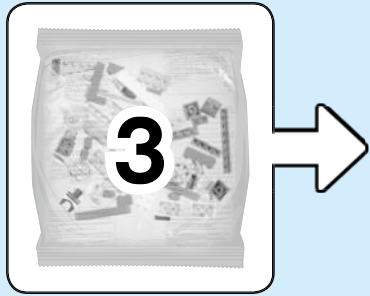

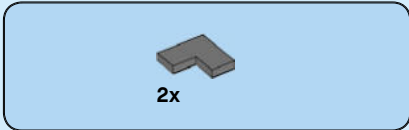
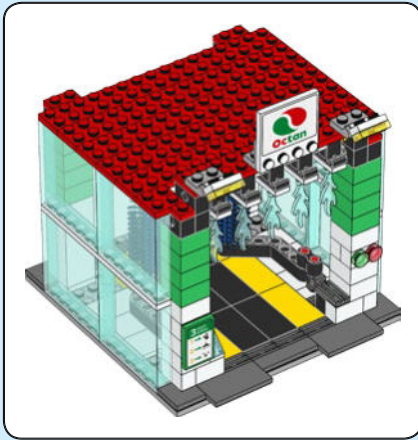
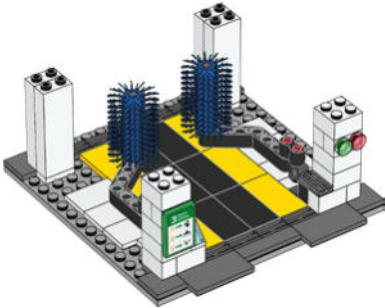
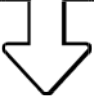

**1**

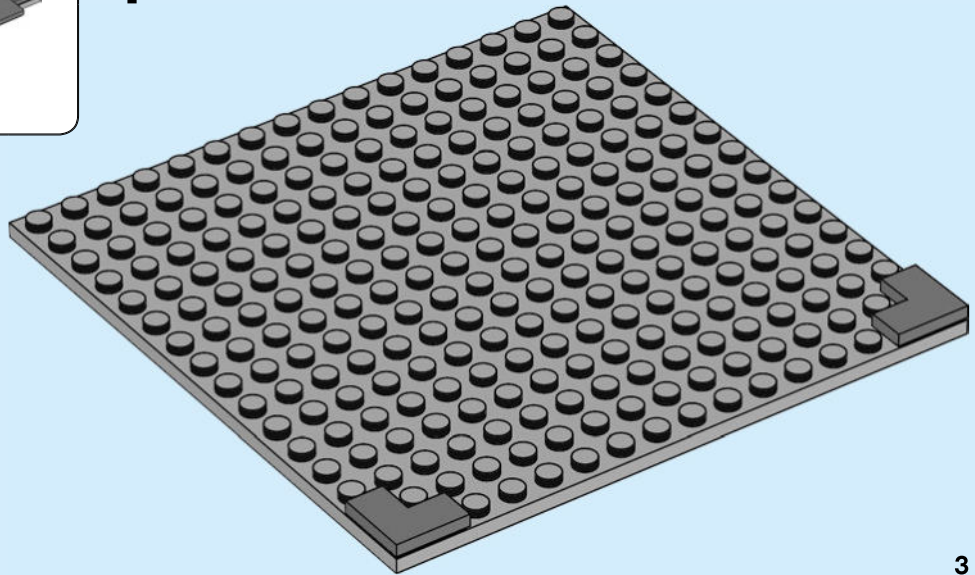



2x

2

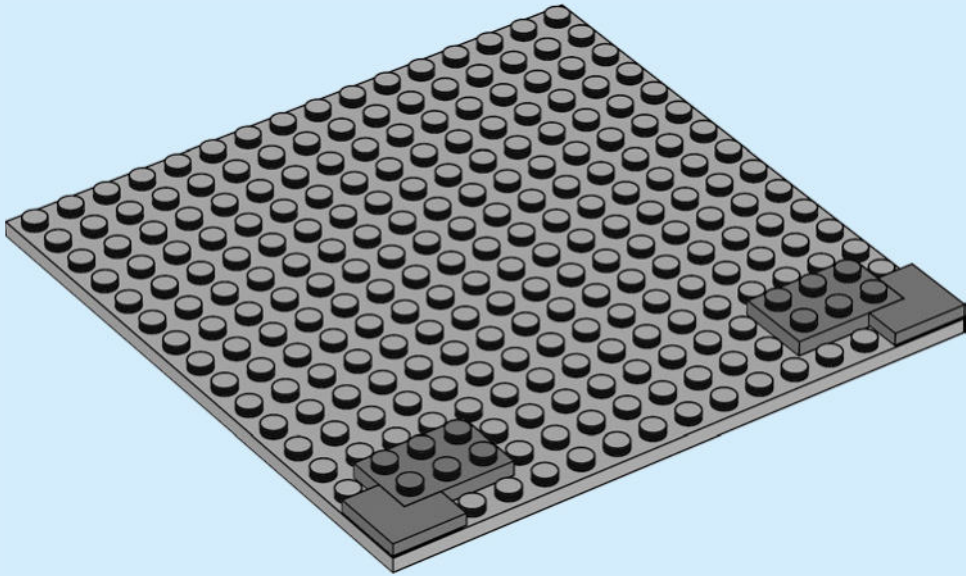

4





4x

3

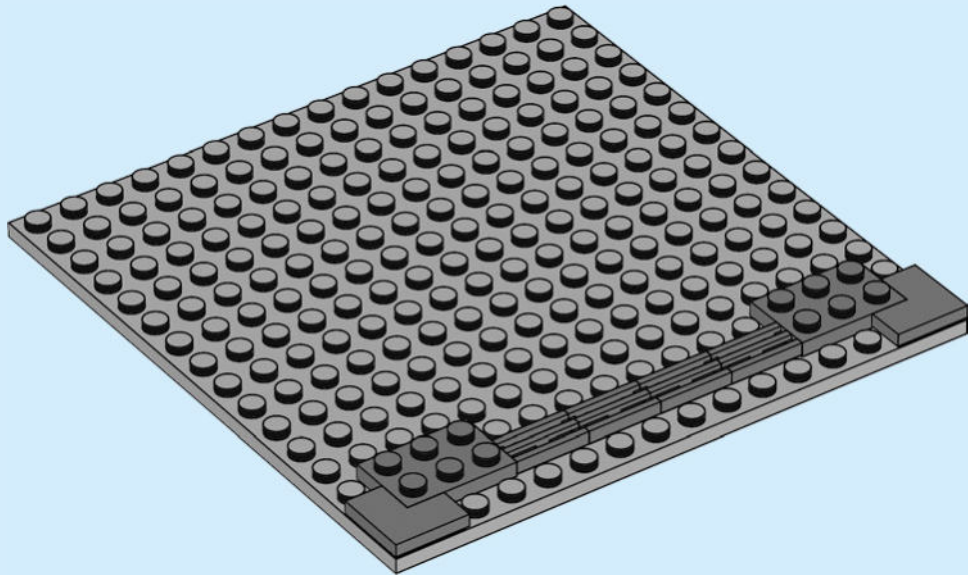



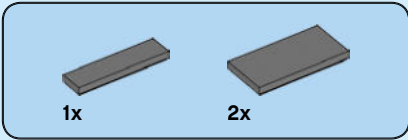

4

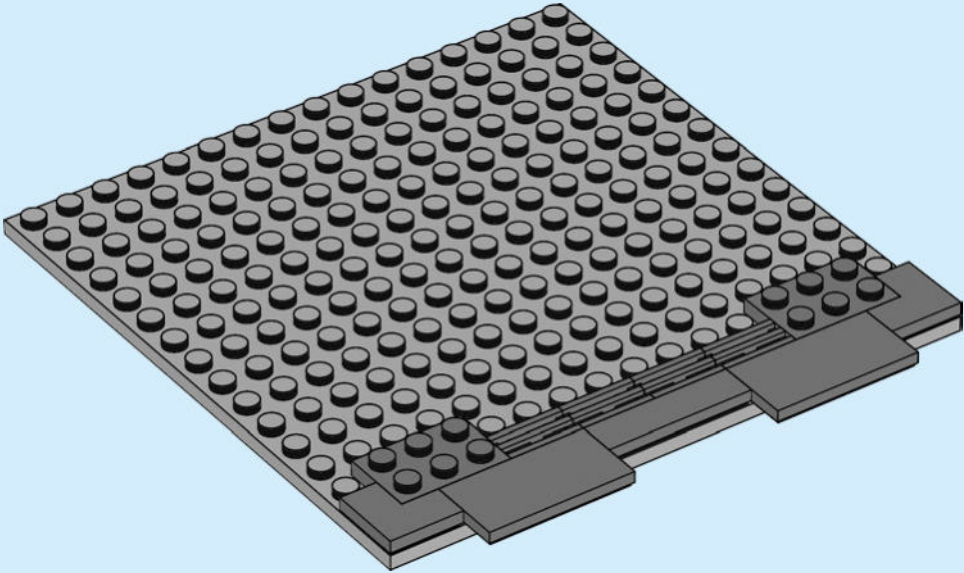

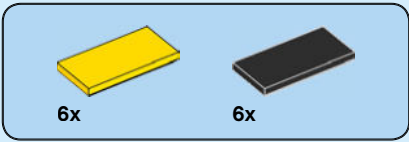

5

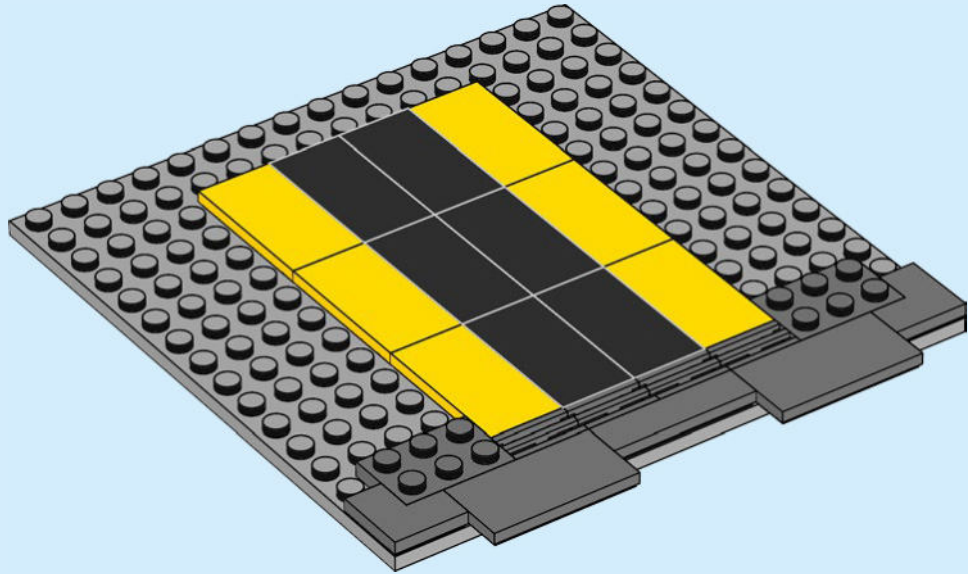



2x



2x

6

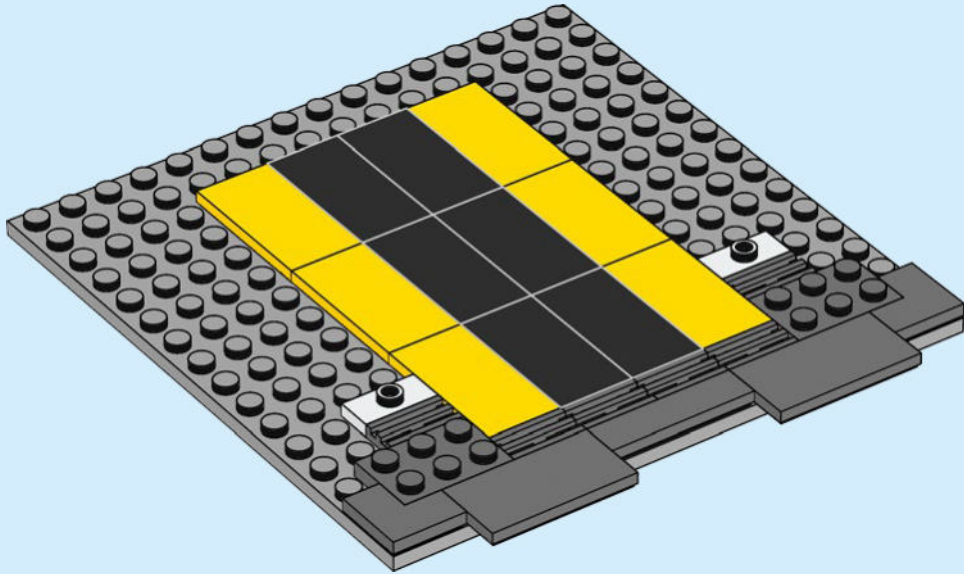

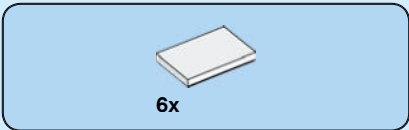

7

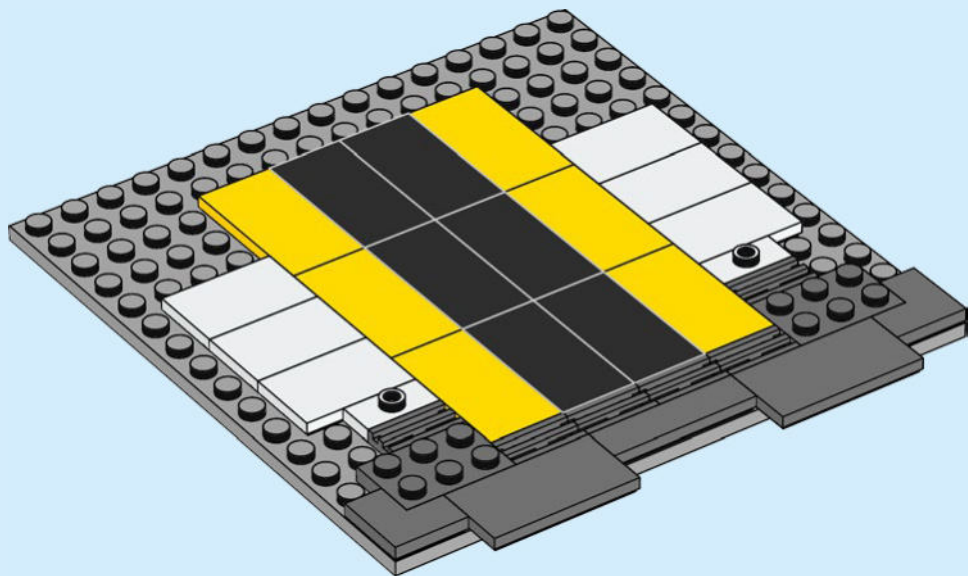

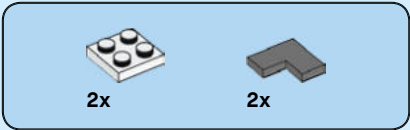

8

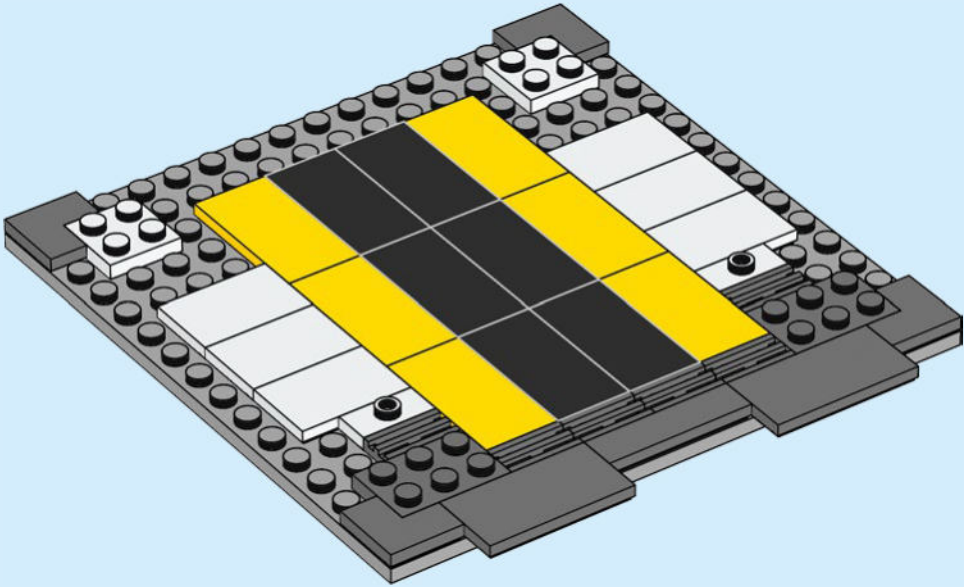



5x

9

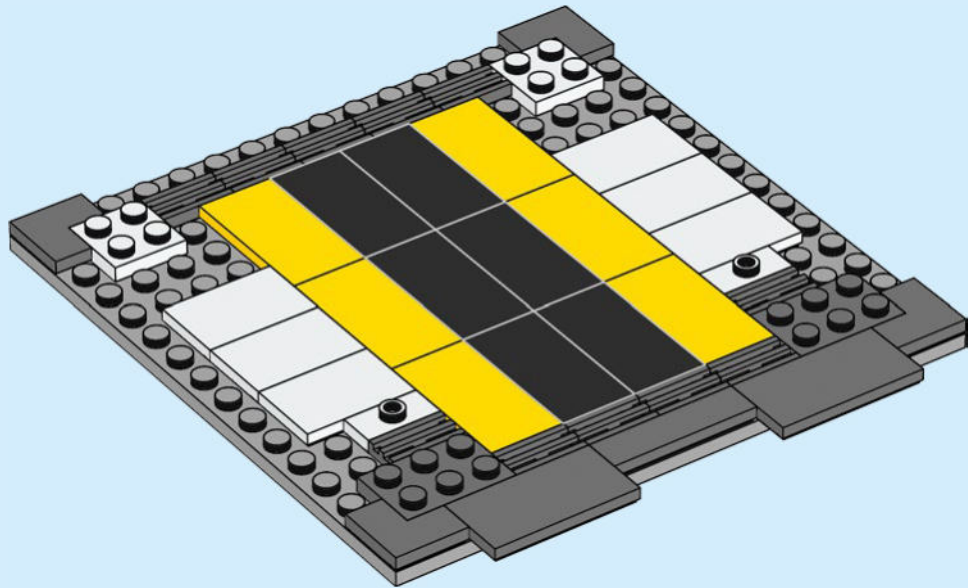



# 10

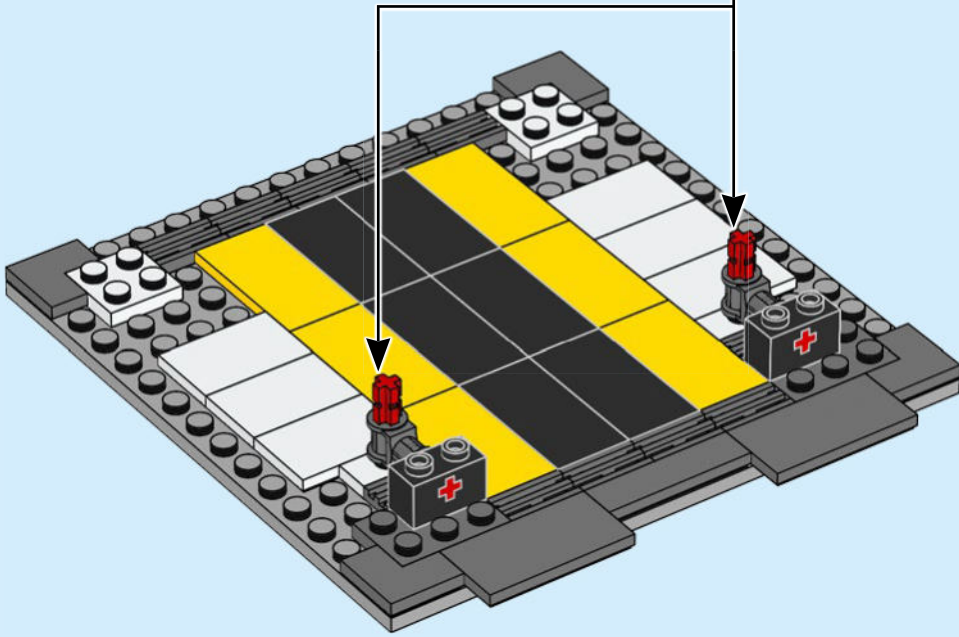



4x

11

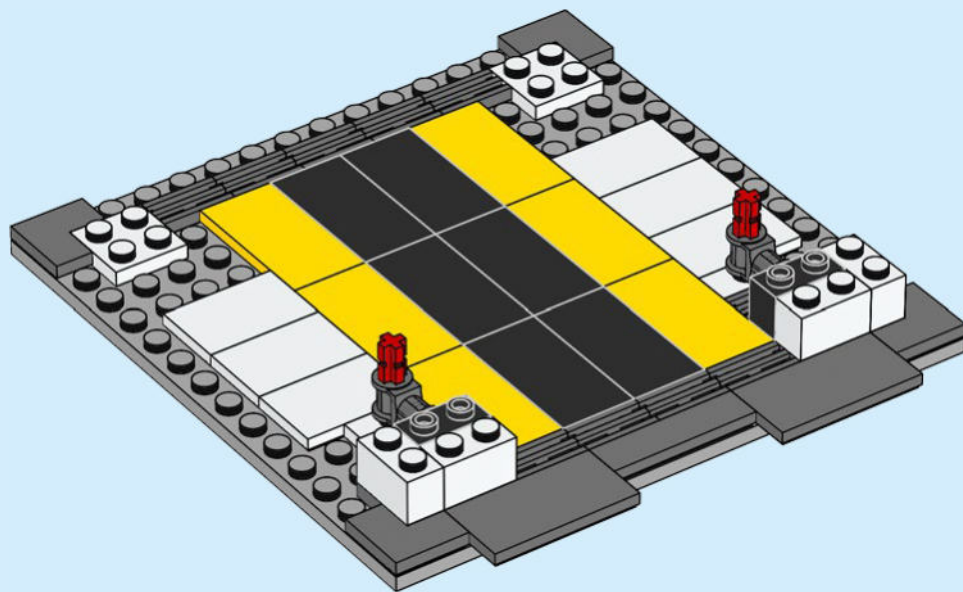





2x

12

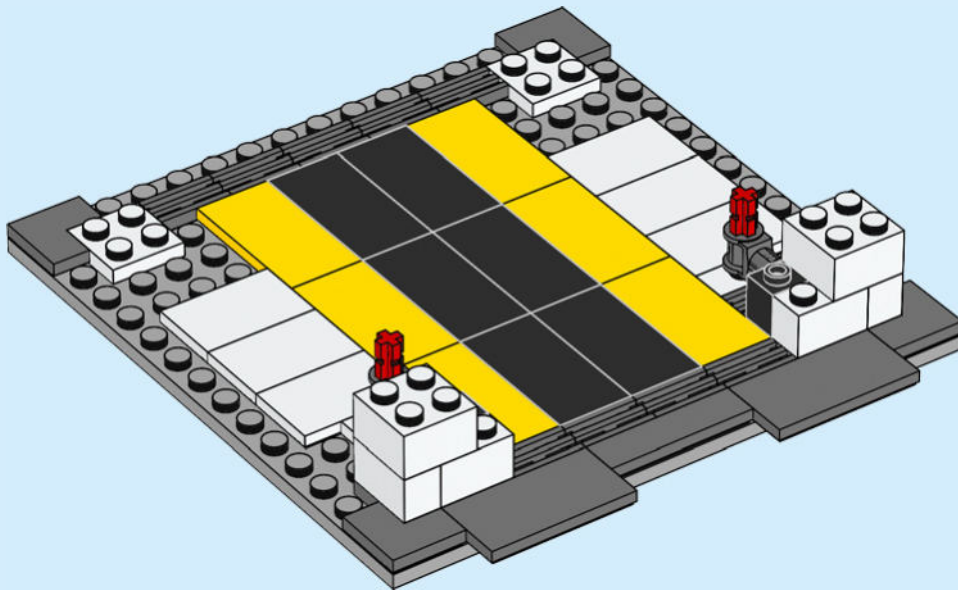



1x



1x

# 13

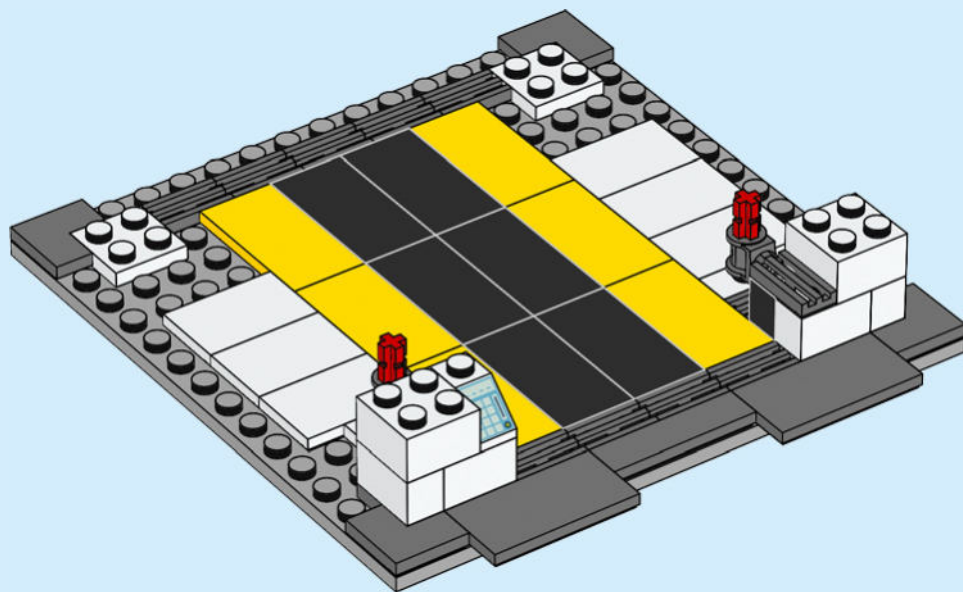

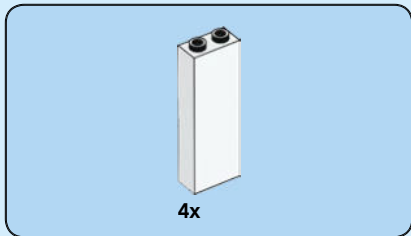

14

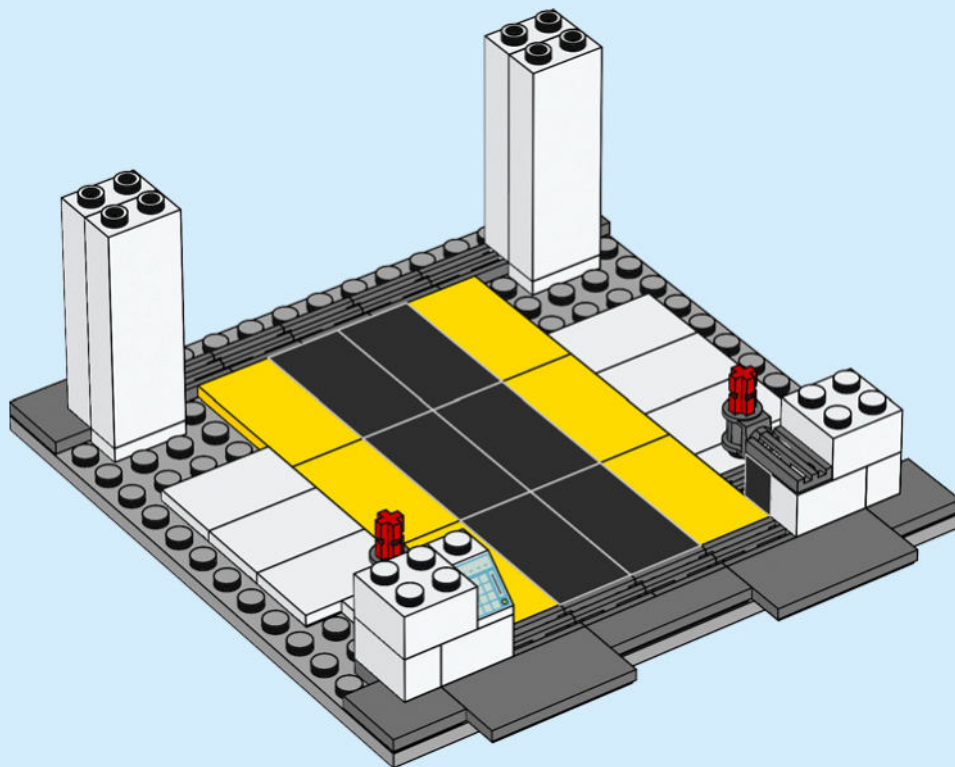

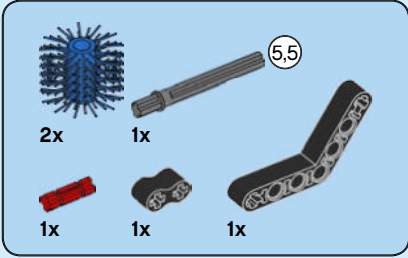
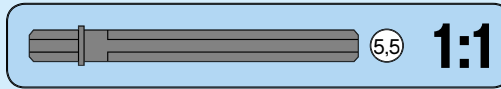
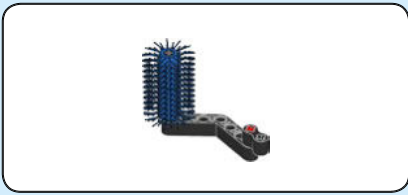

# 15

1

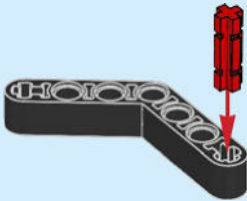

2



3

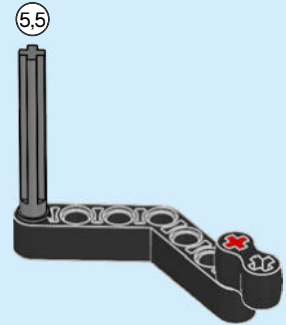

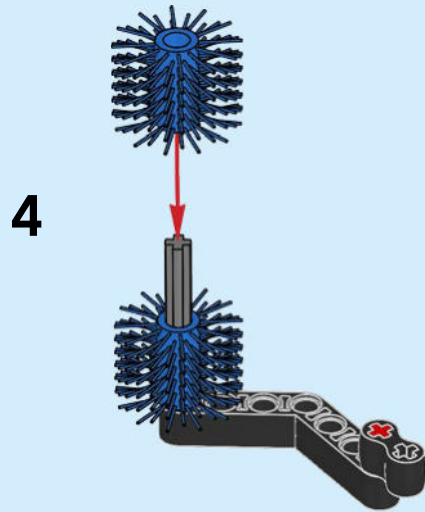

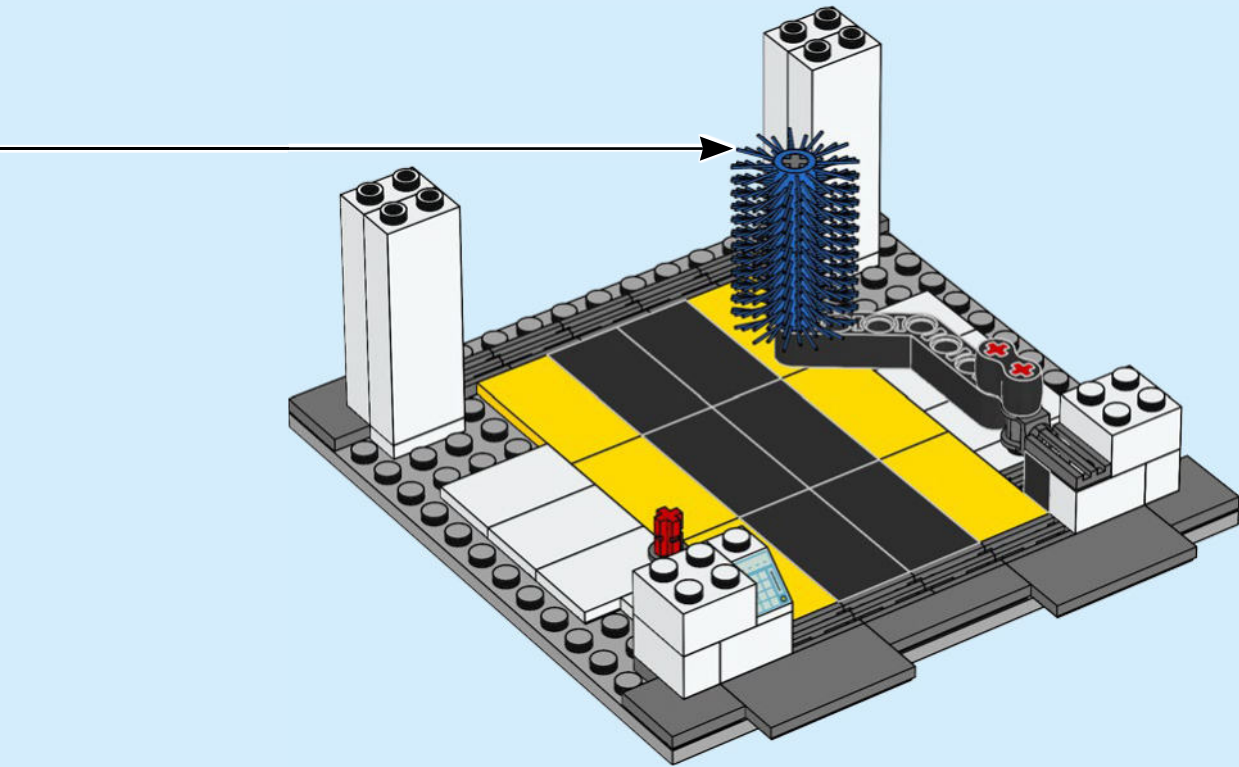

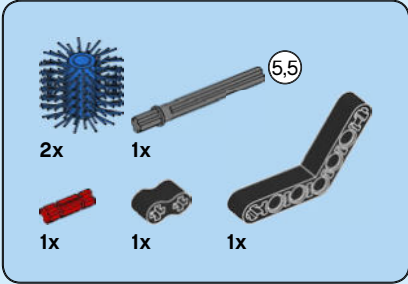
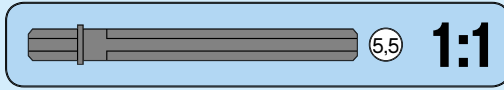
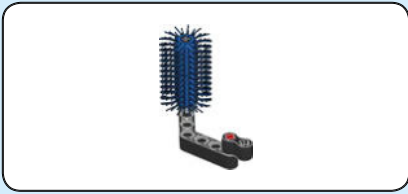

16

1

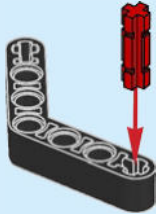

2

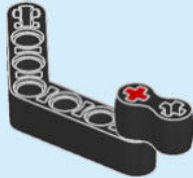

3

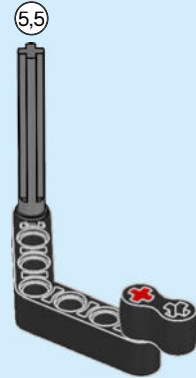

4

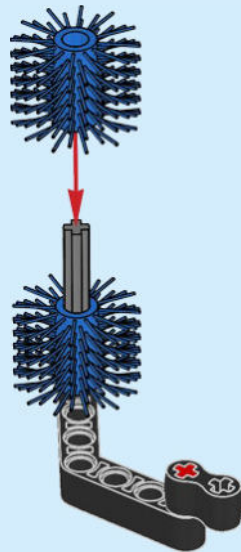



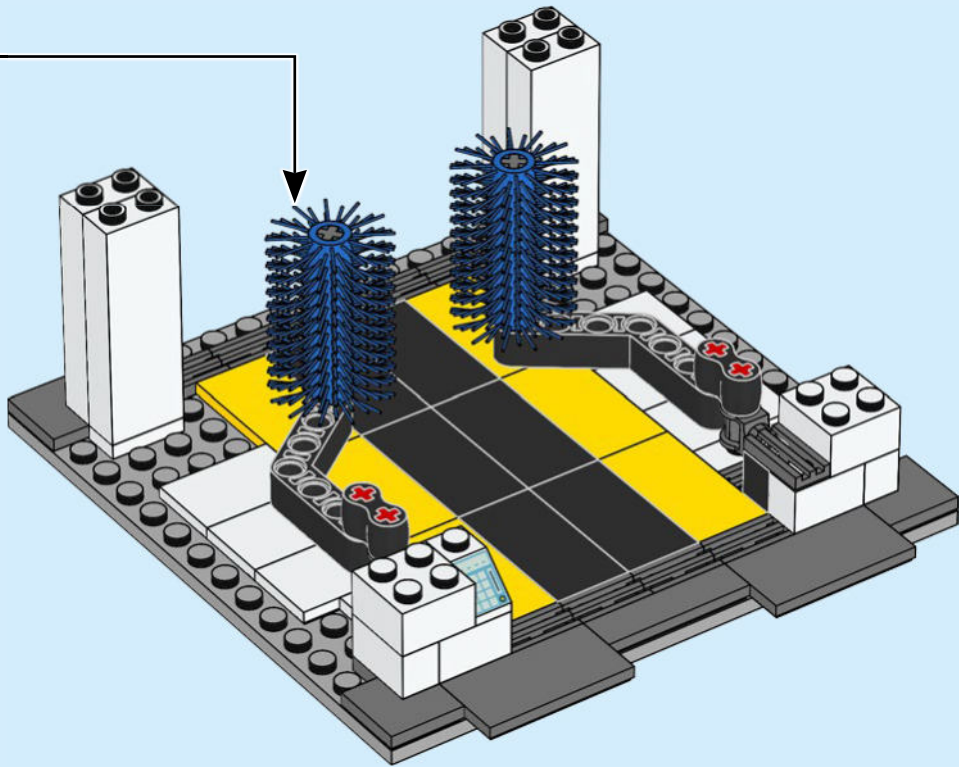



2x

17

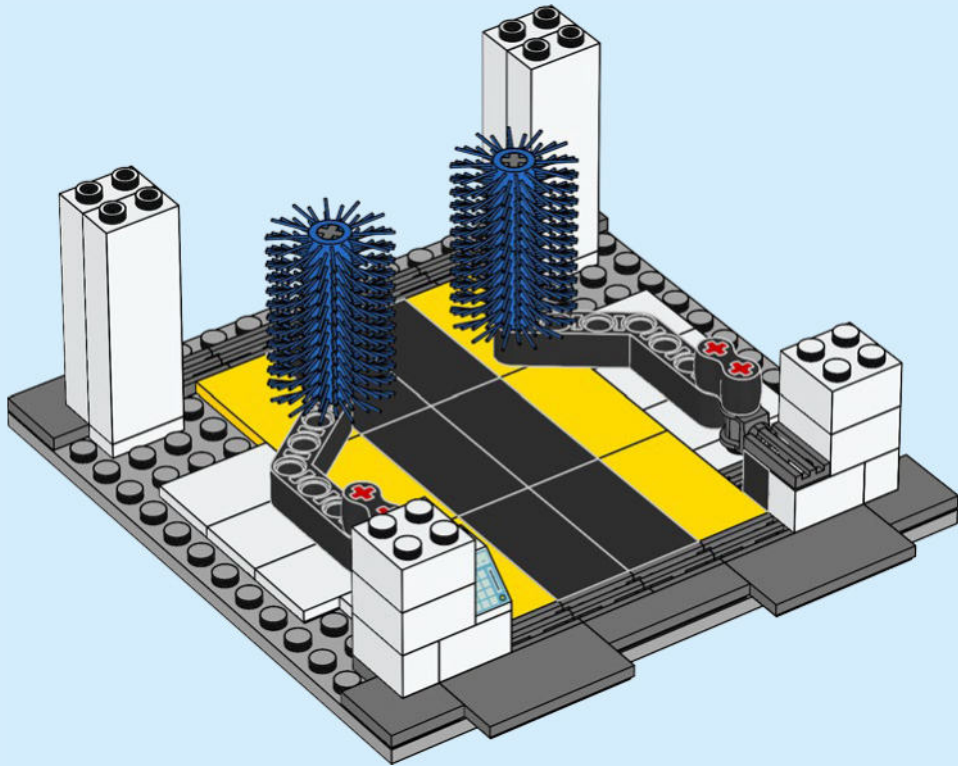



2x

18

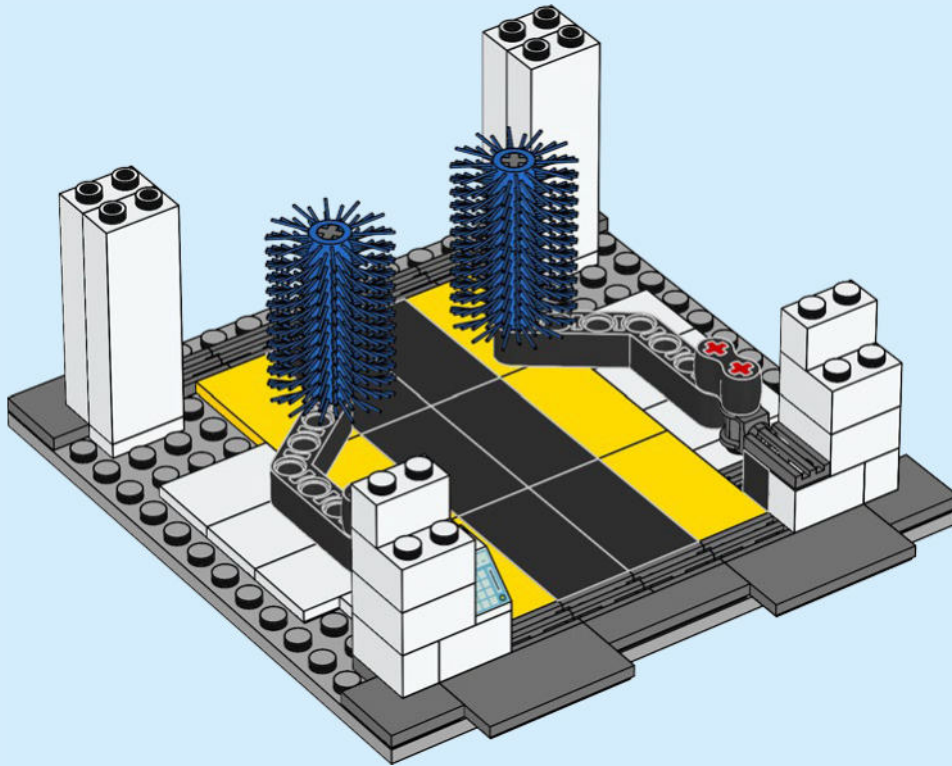



19

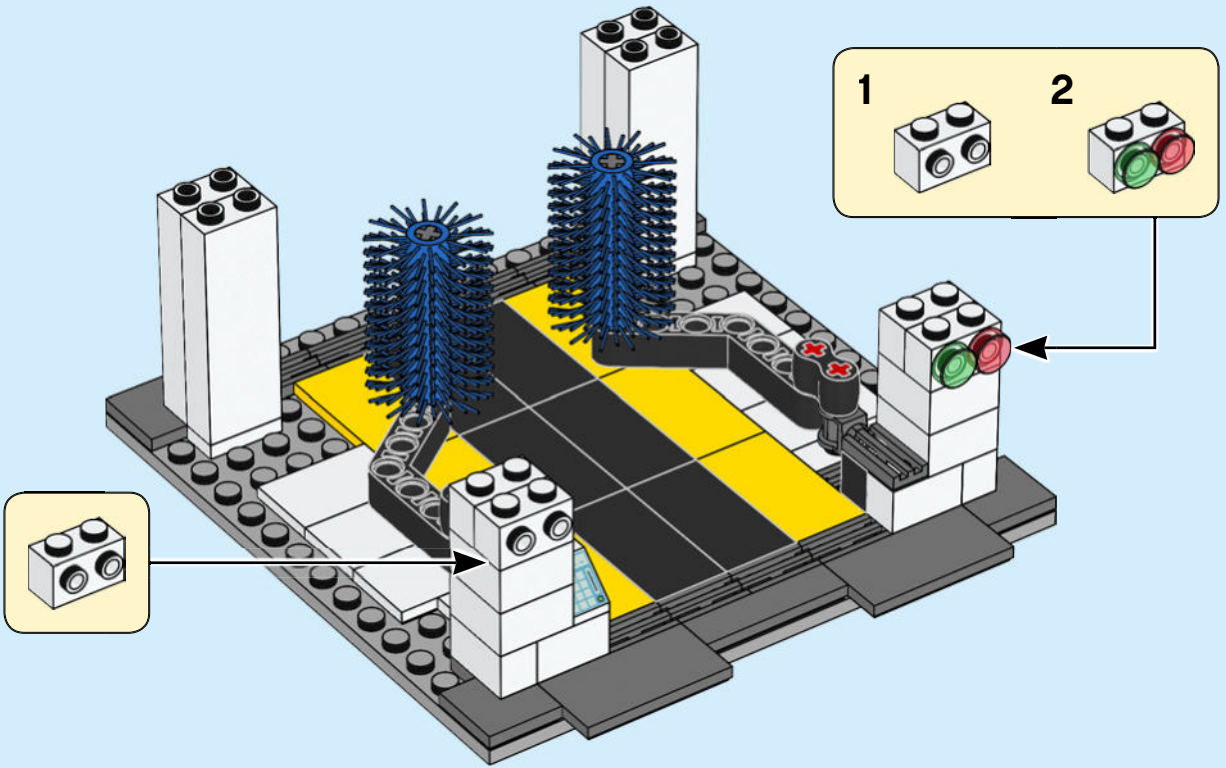



2x

20

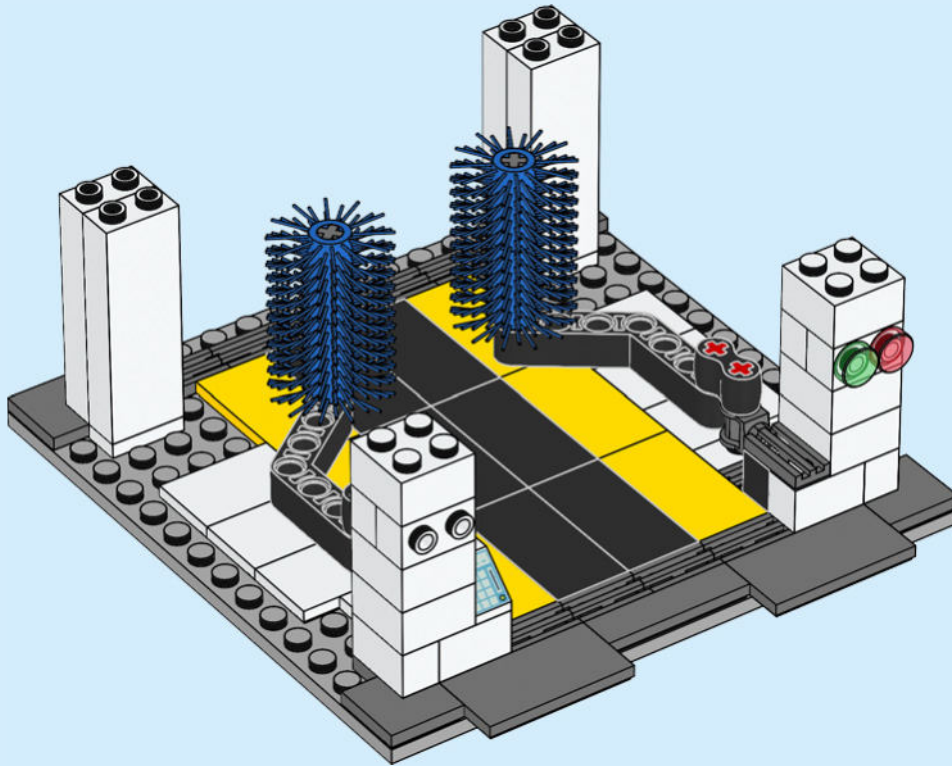

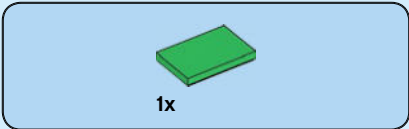

# 21

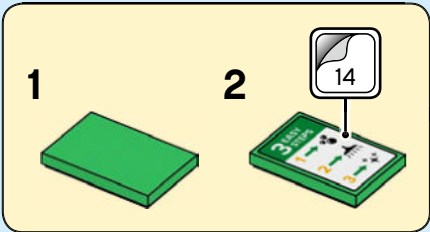
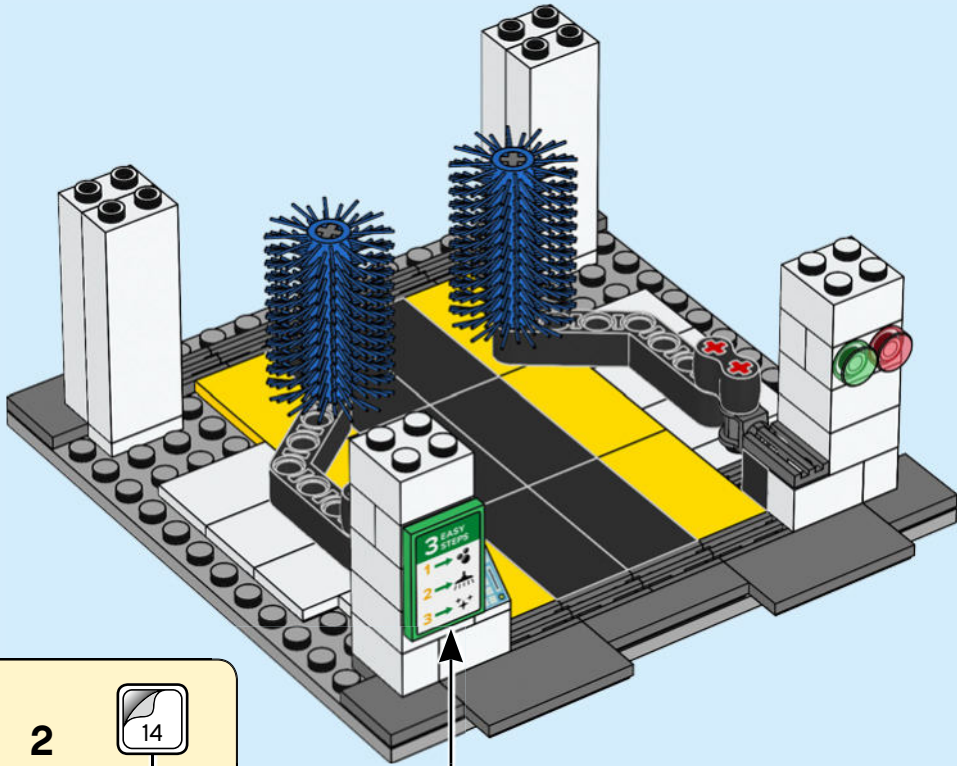

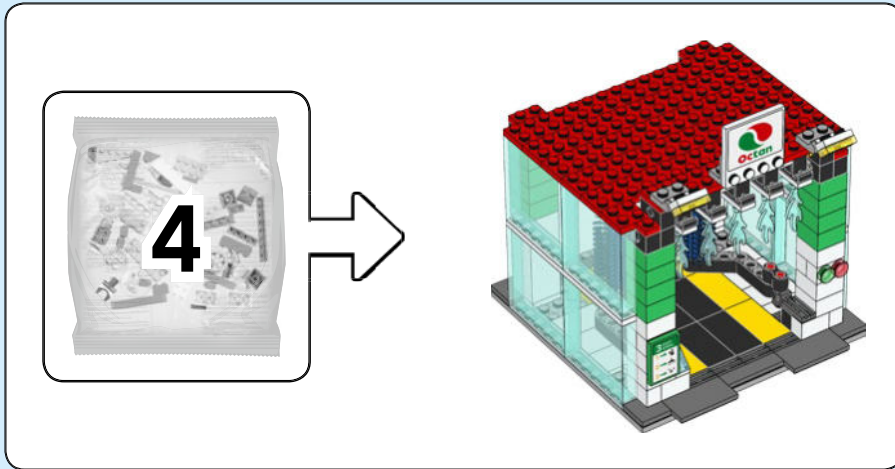





16x

22

1

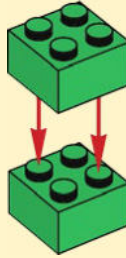

2

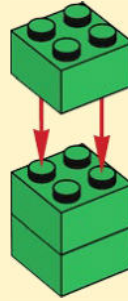

3

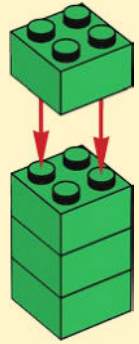

4x

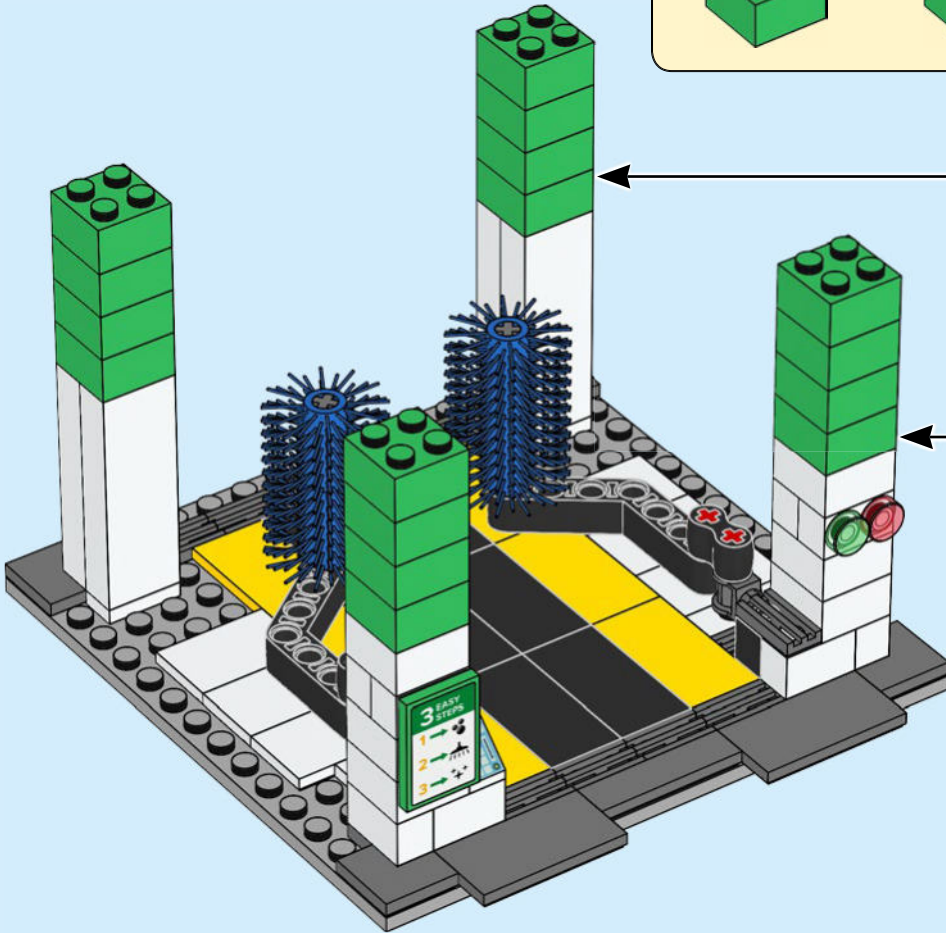



4x

23

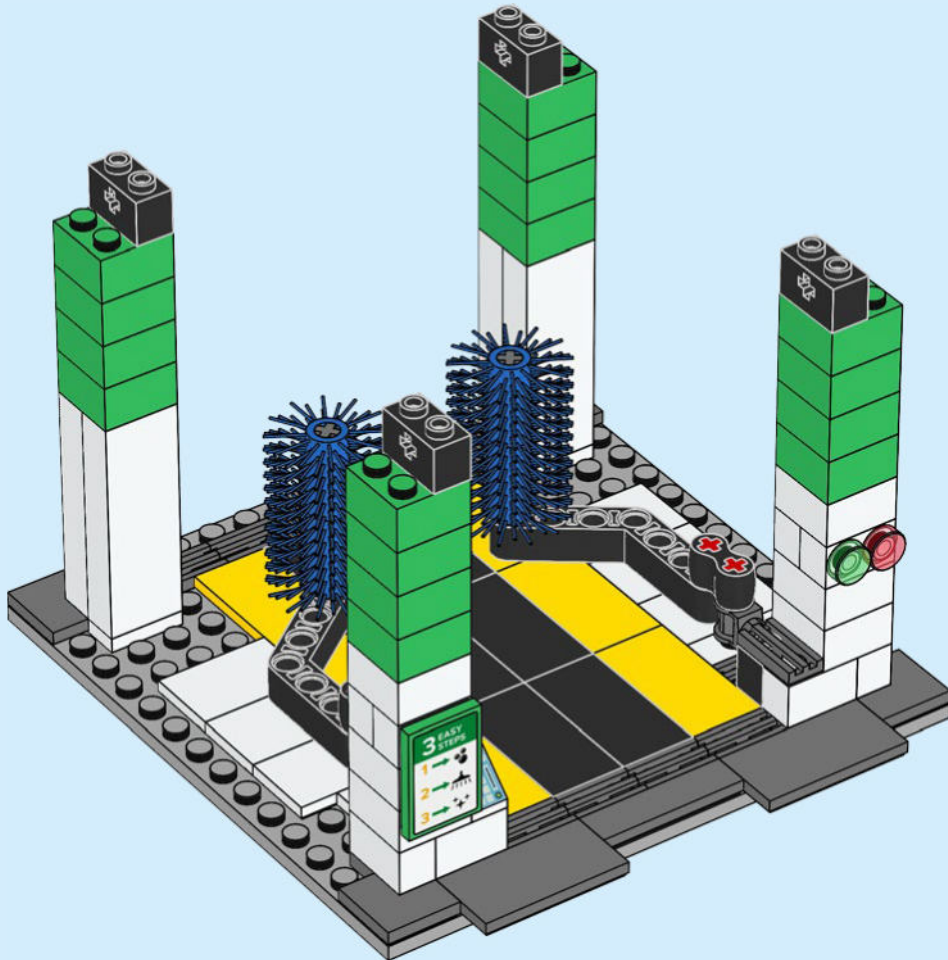

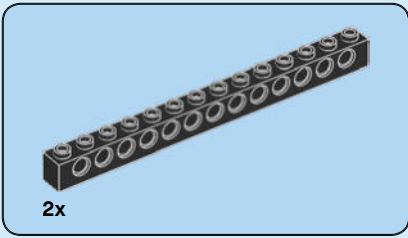

24

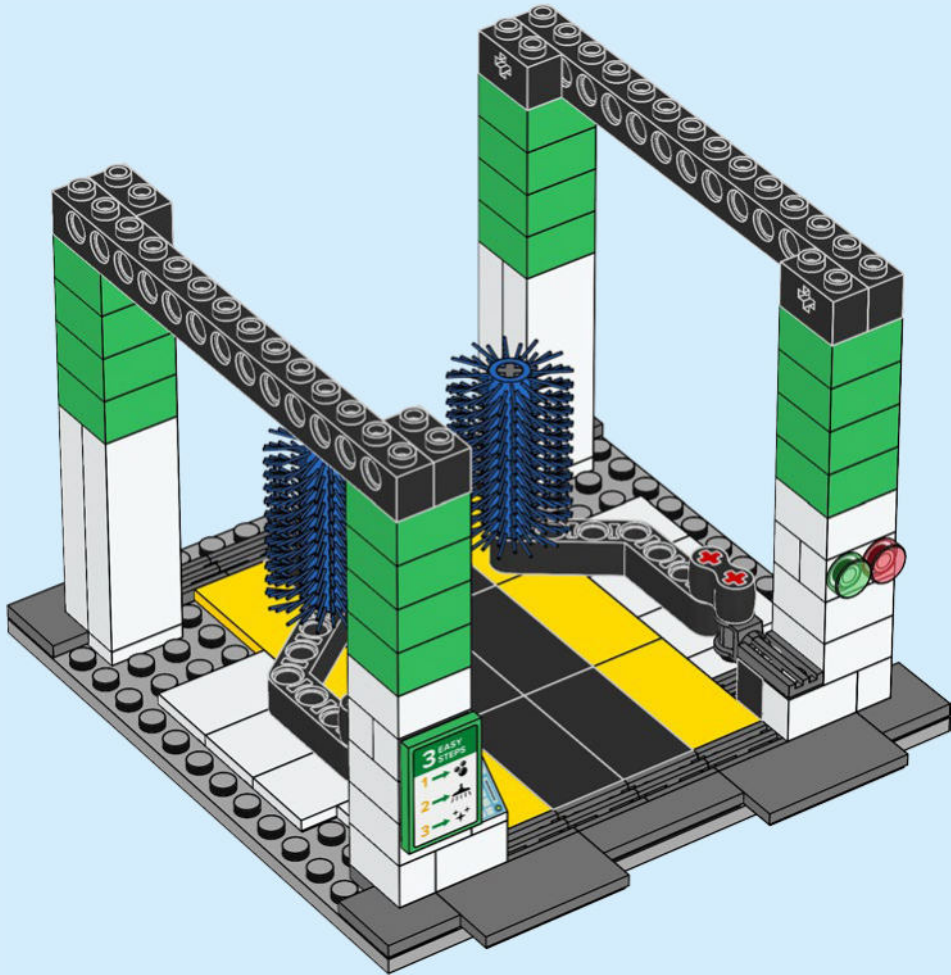



2x

25

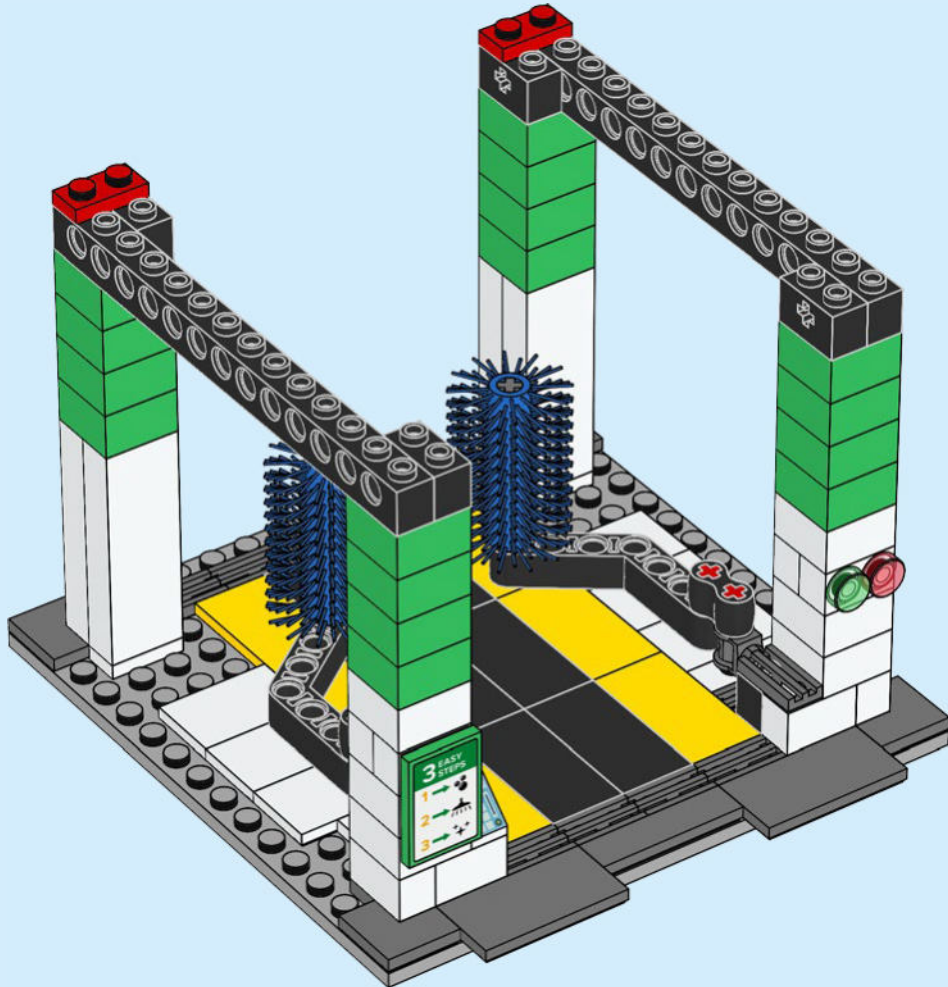

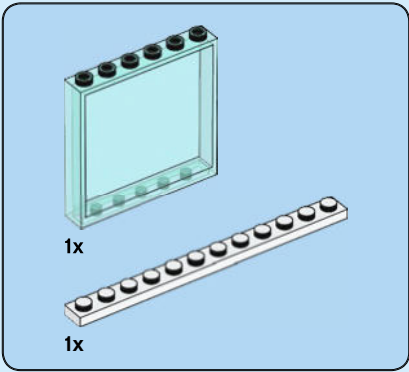
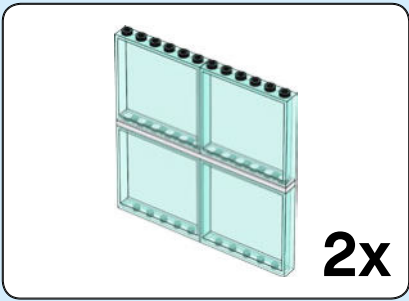

26

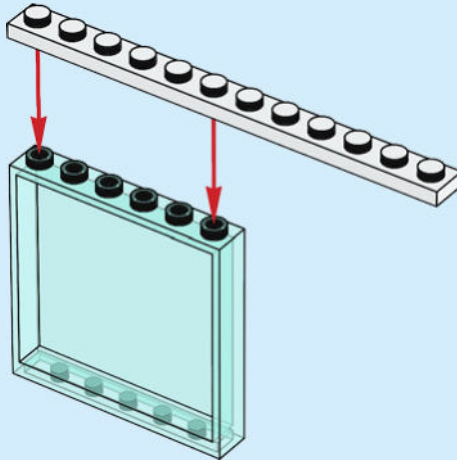

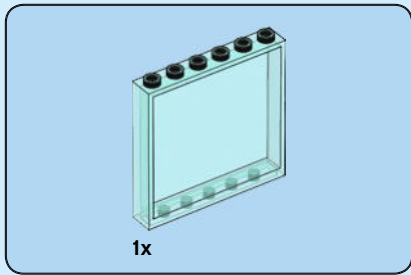

27

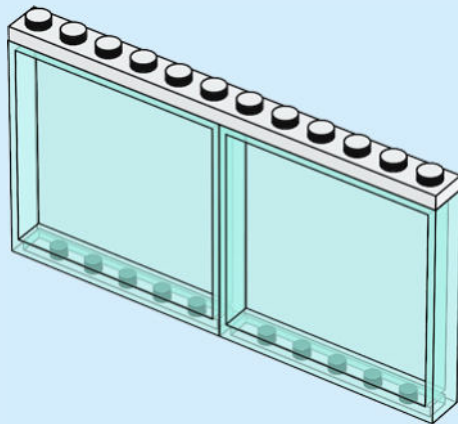

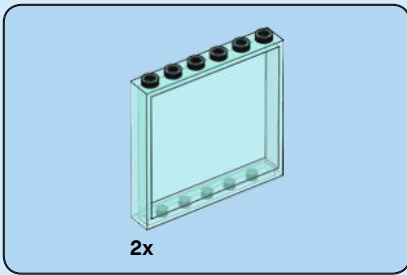

28

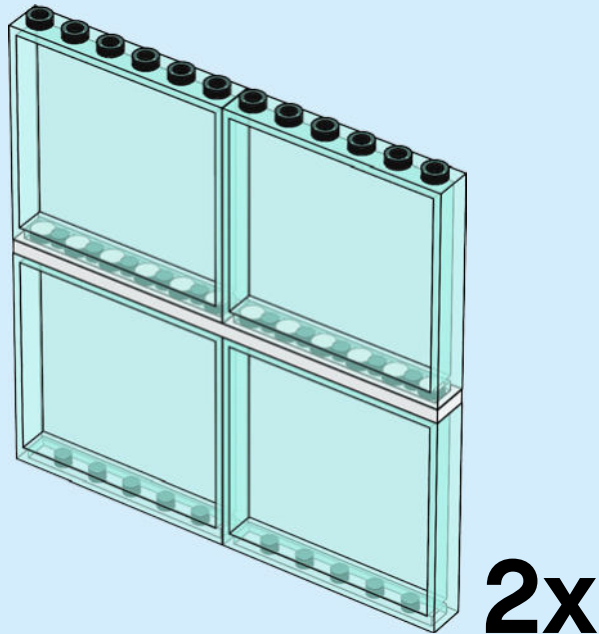



29

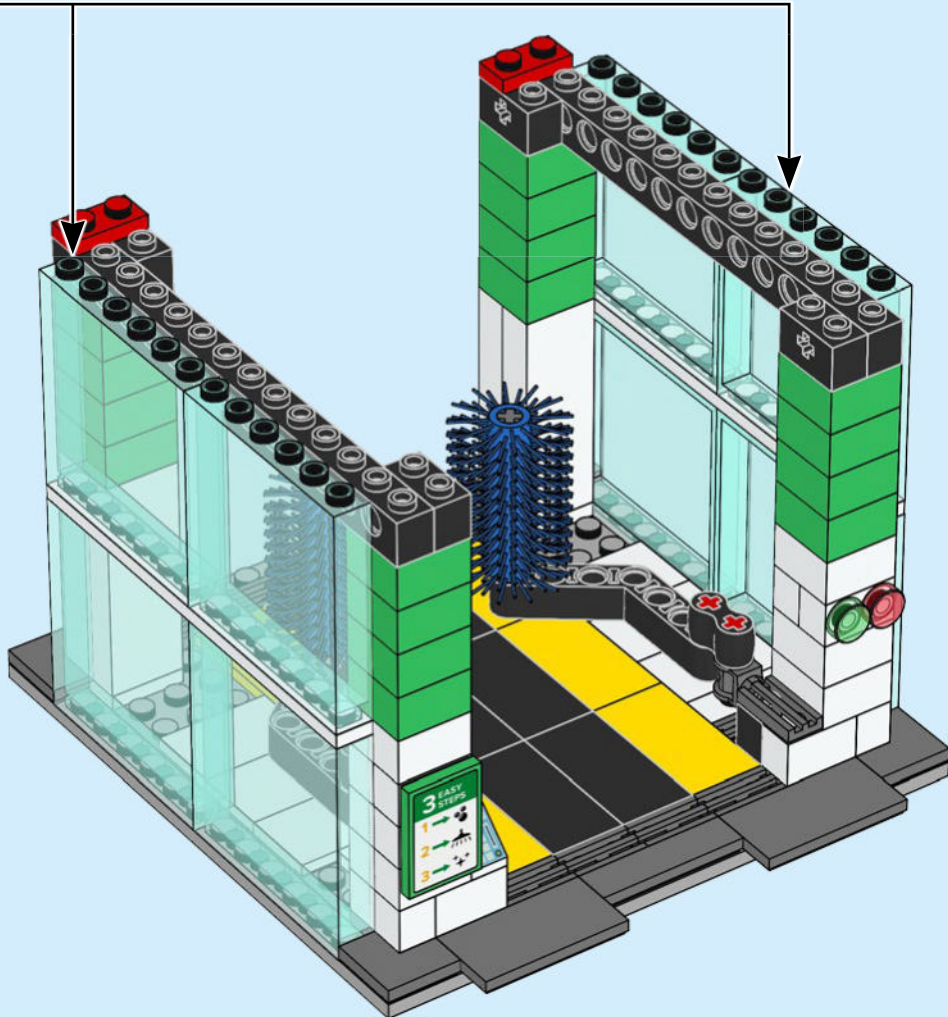





2x



2x

# 30

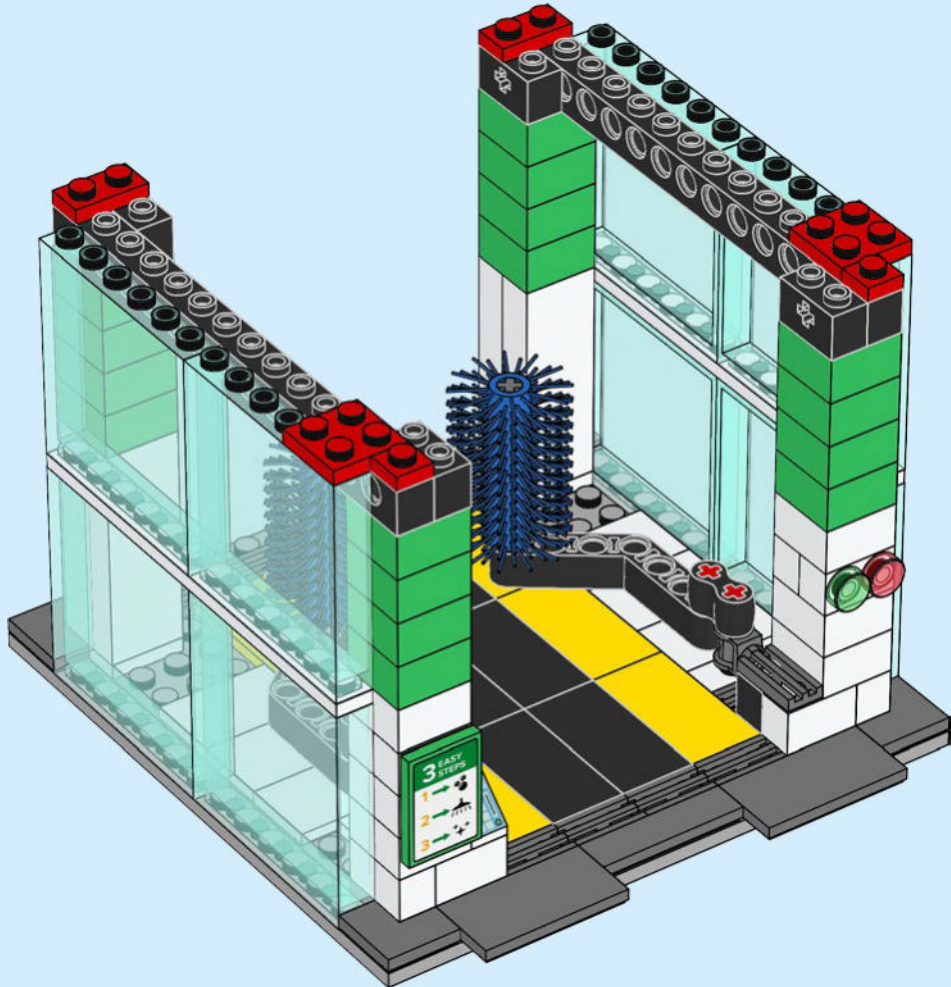

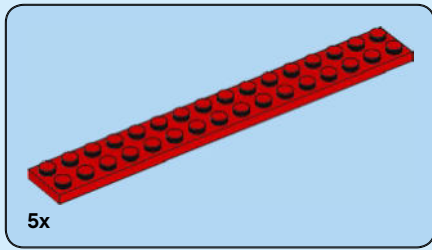

31

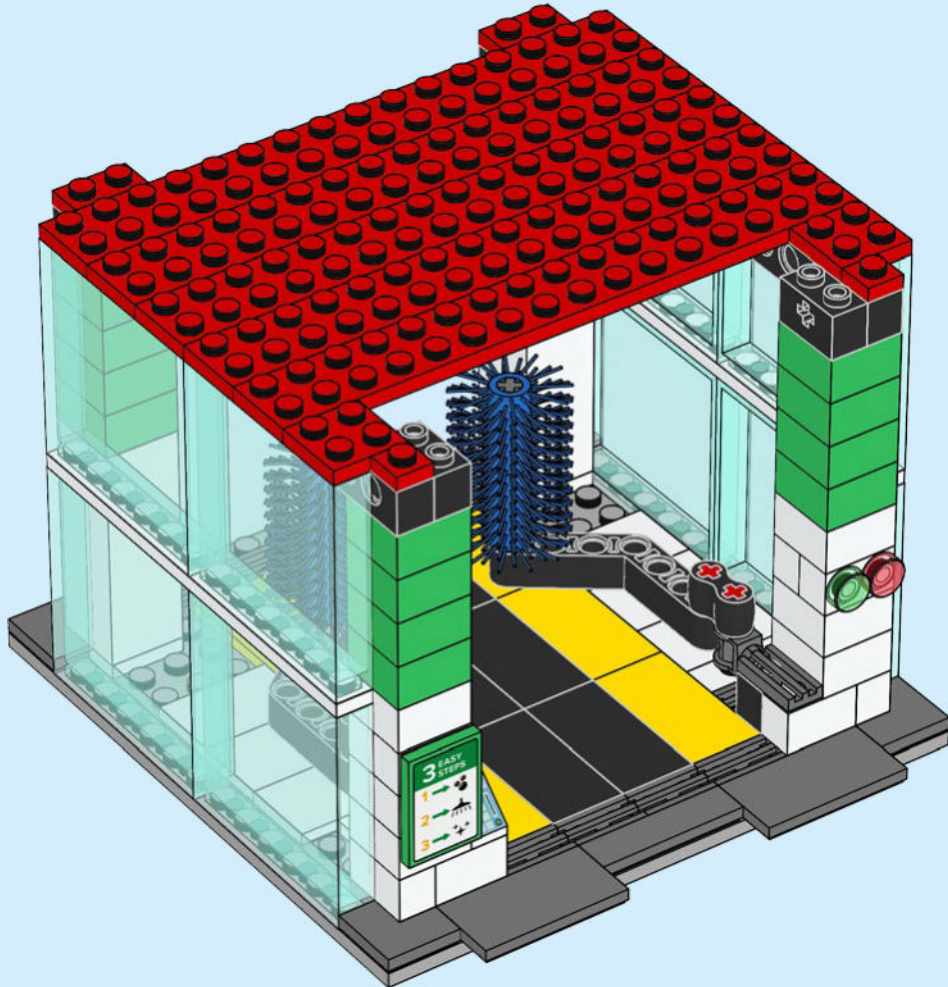

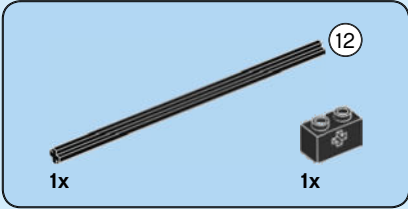
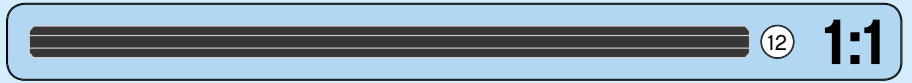
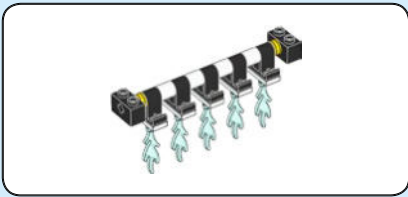

32

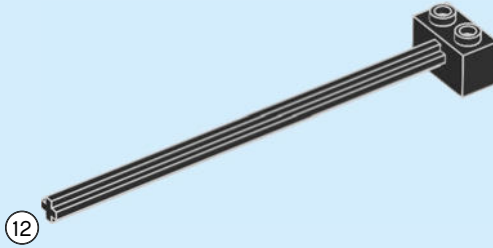



1x

33

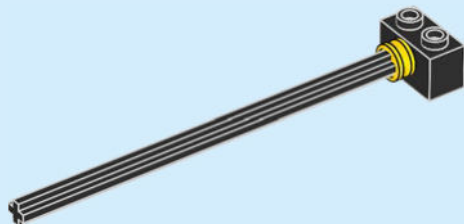

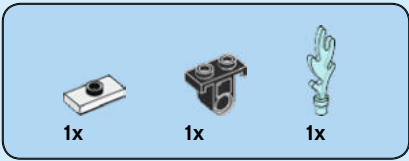

# 34

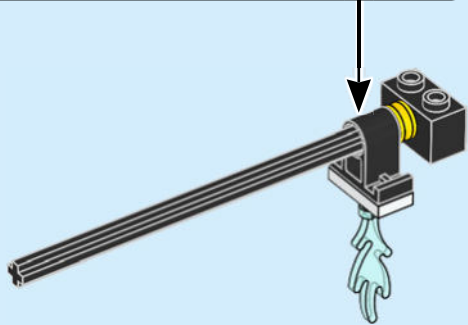
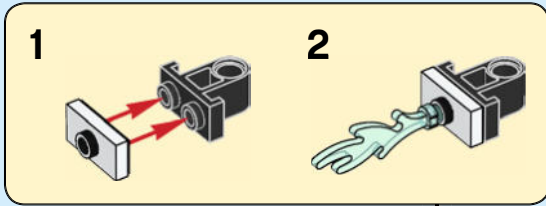



1x

35

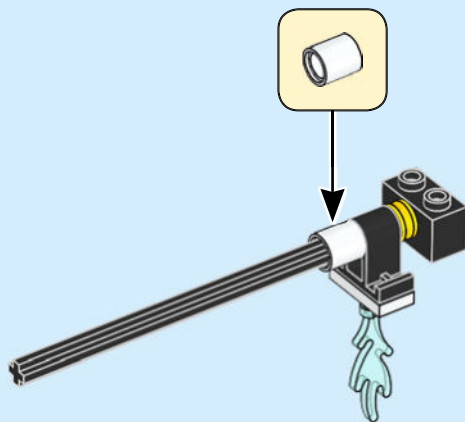



36

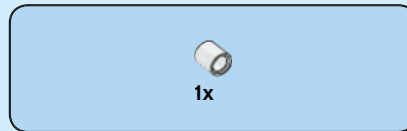
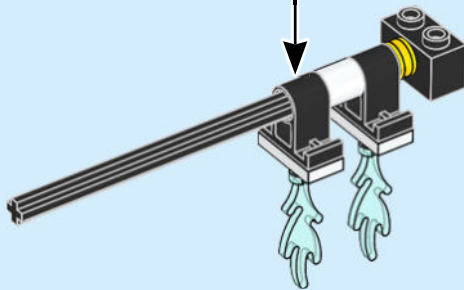
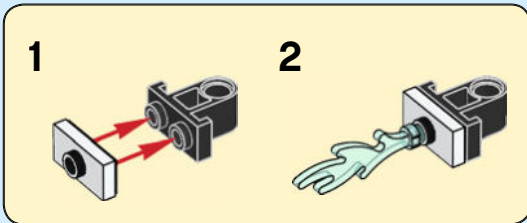

37

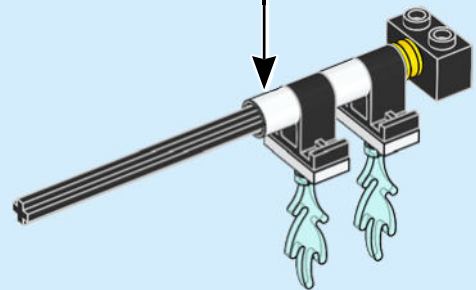

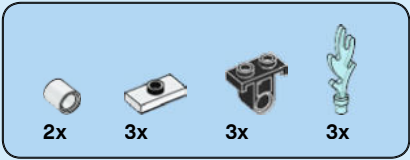

# 38

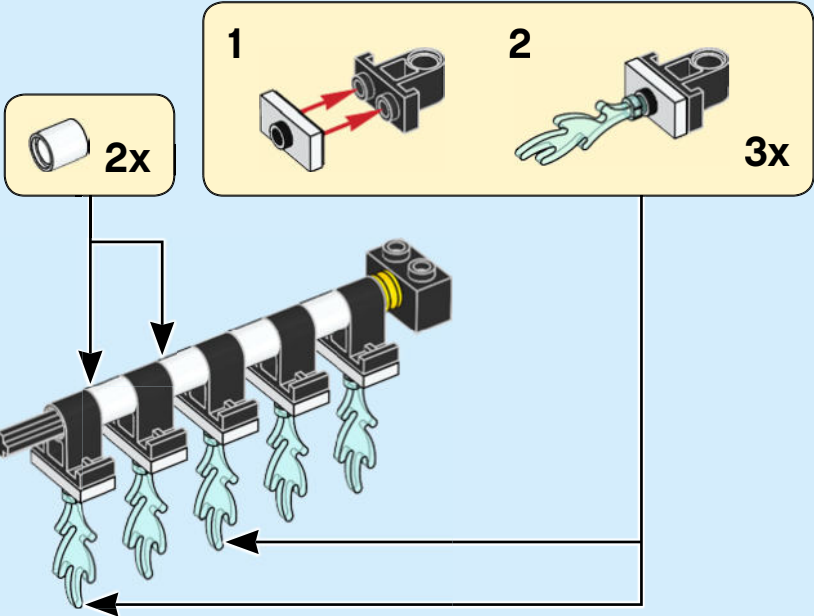





1x

39

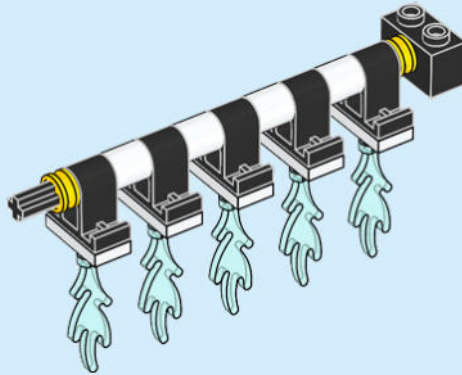



1x

40

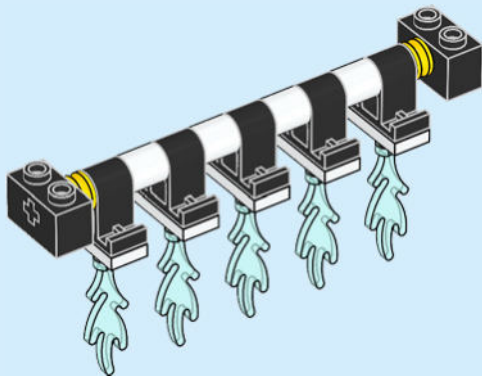

41

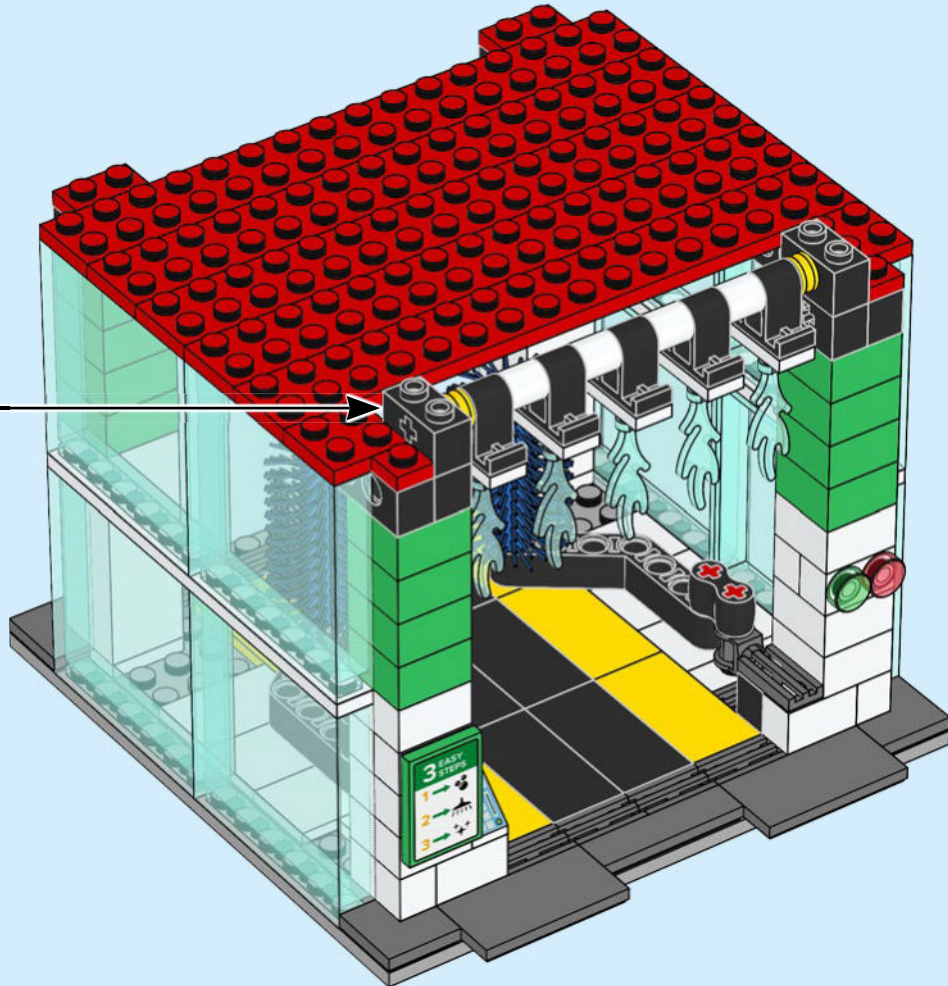

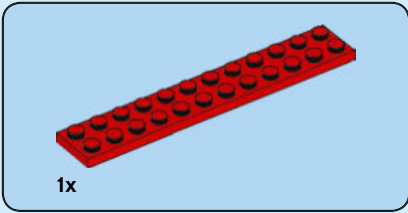

42

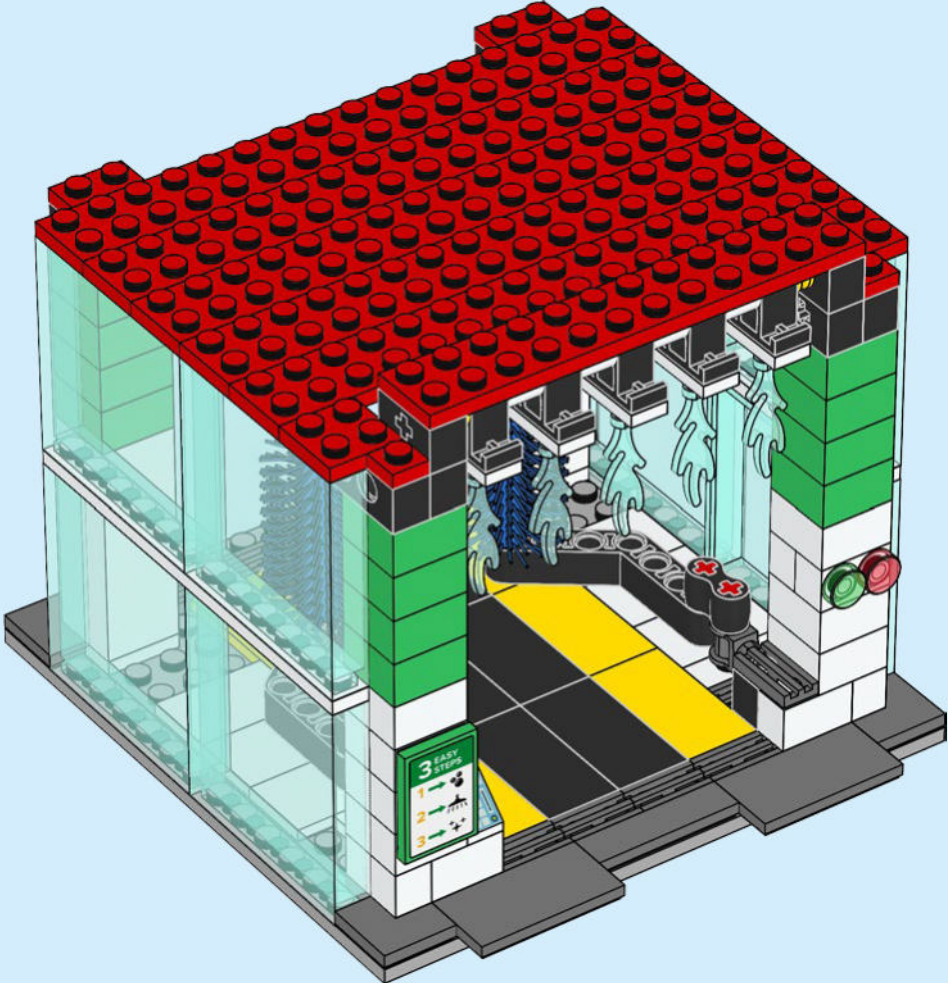

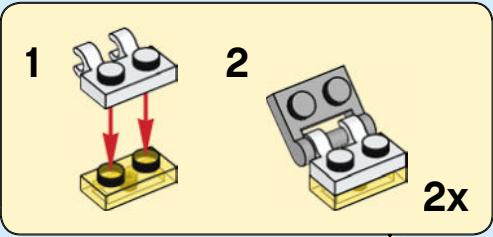
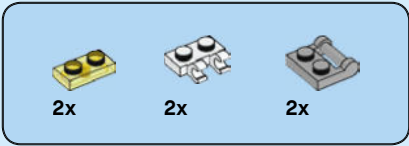

43

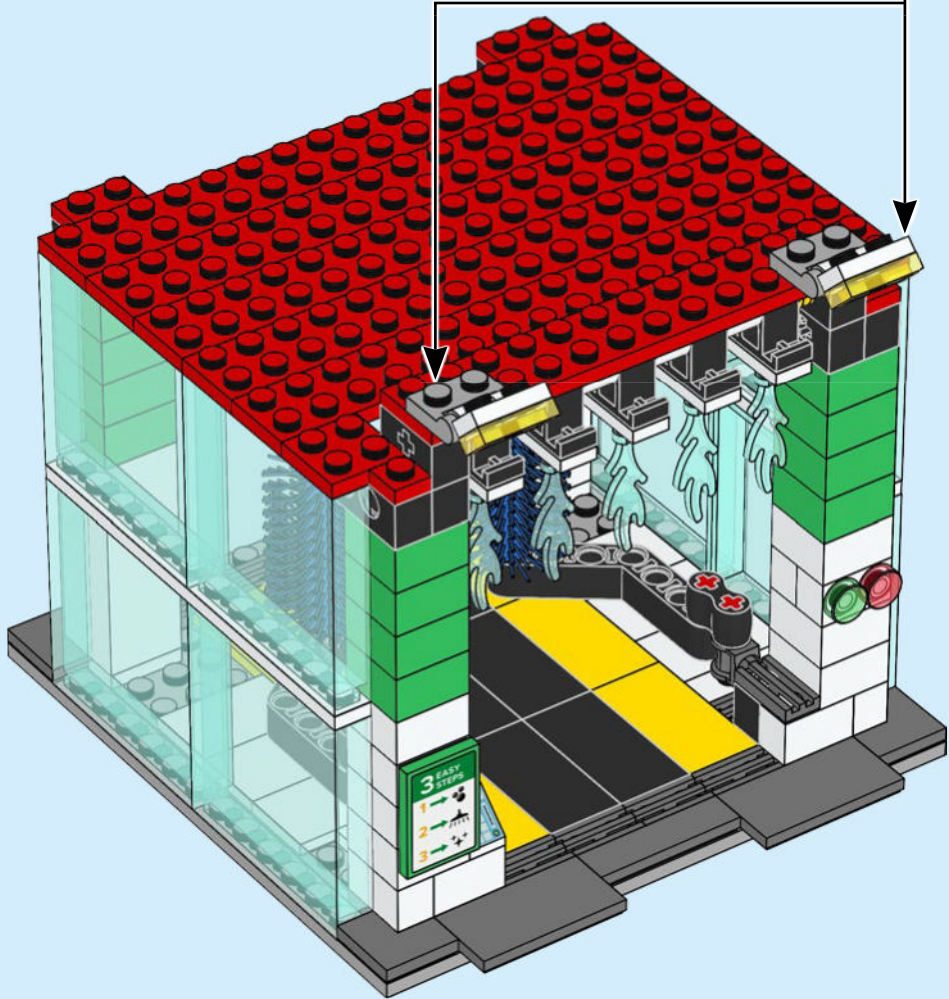

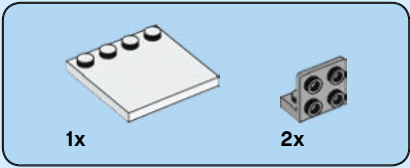

# 44

1

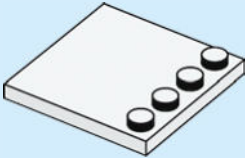

2

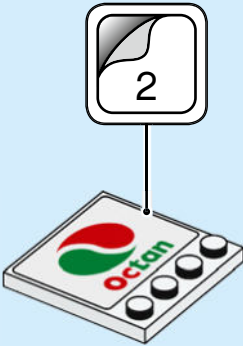

3

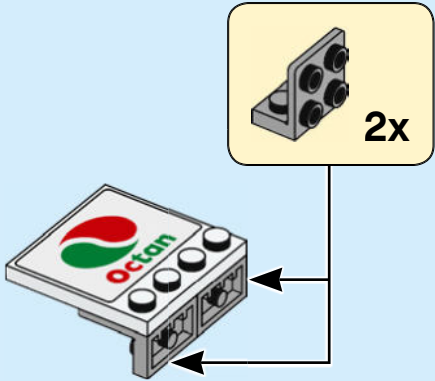



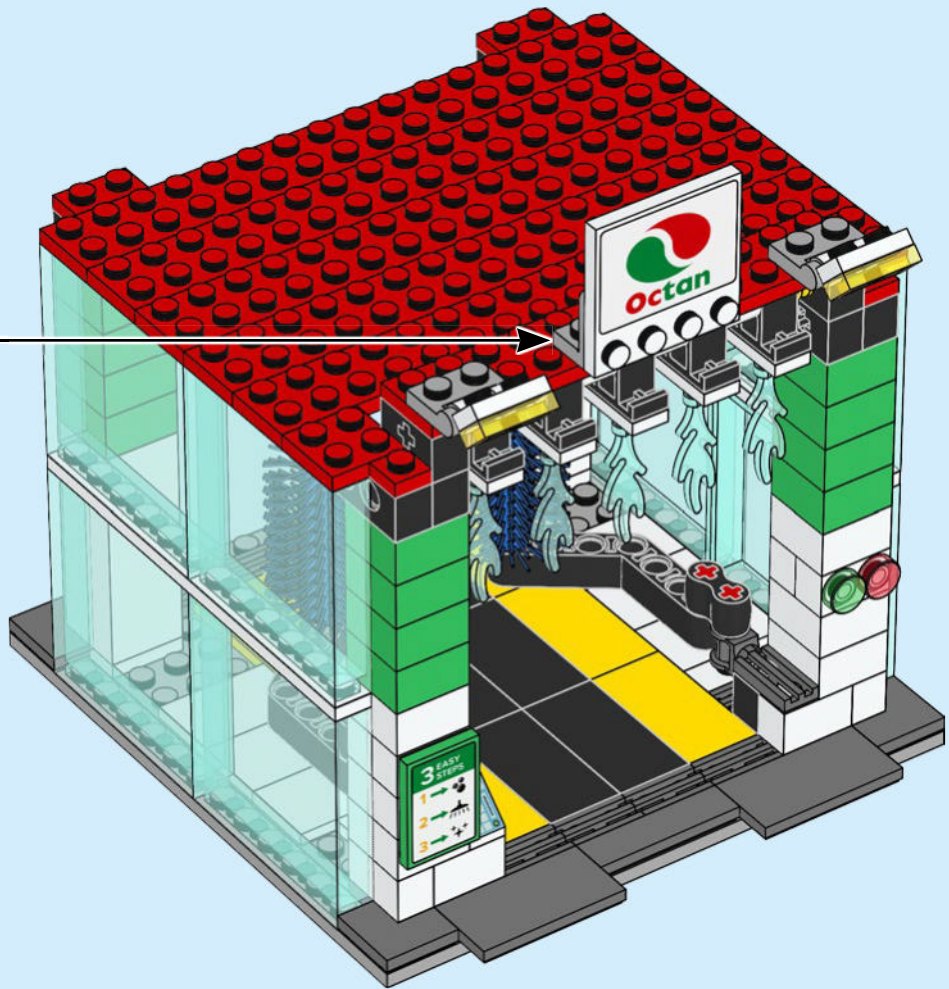

45

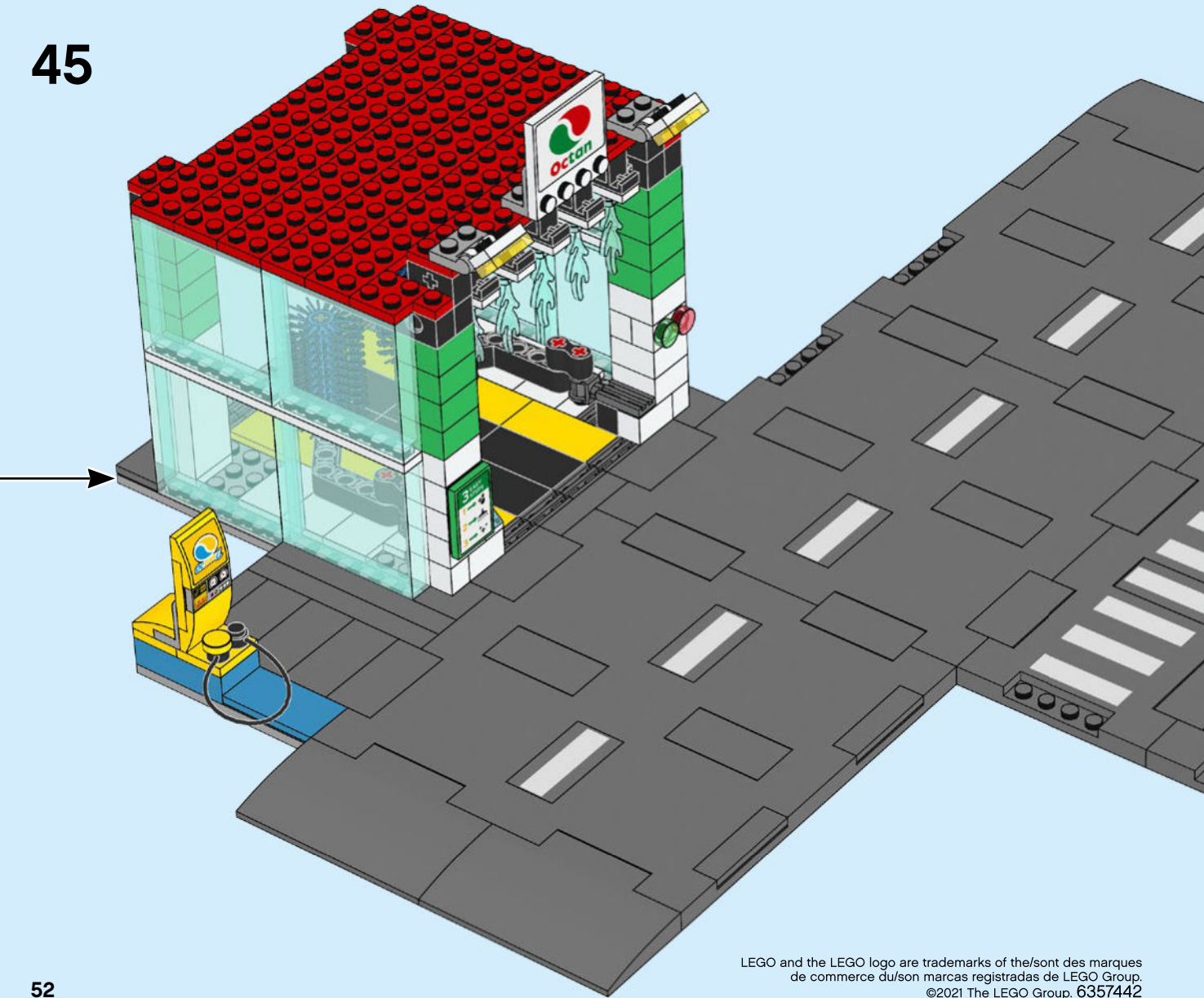

52





# CITY

60292



3

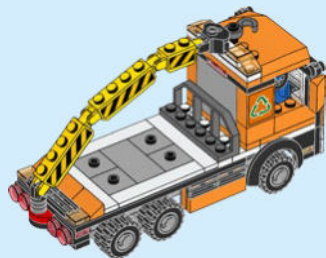
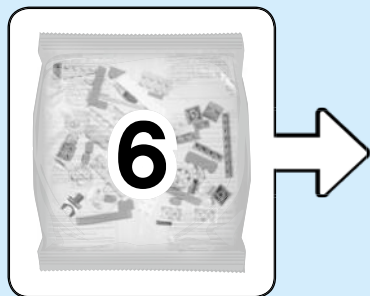
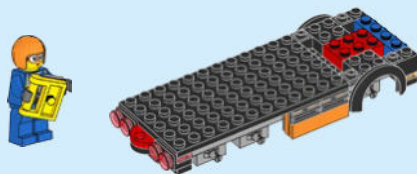

5



1

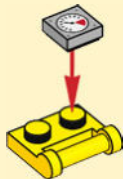

2



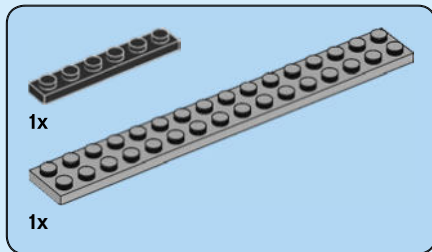

1

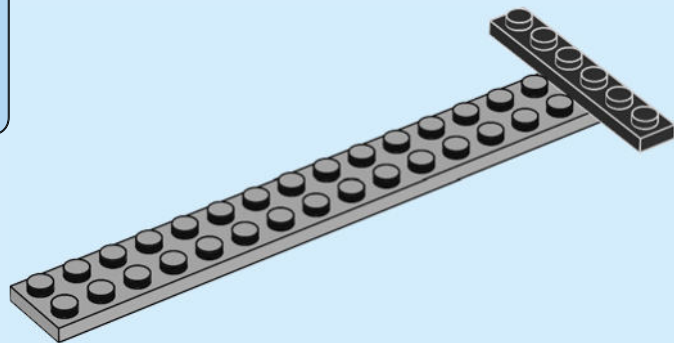



2x



1x

2

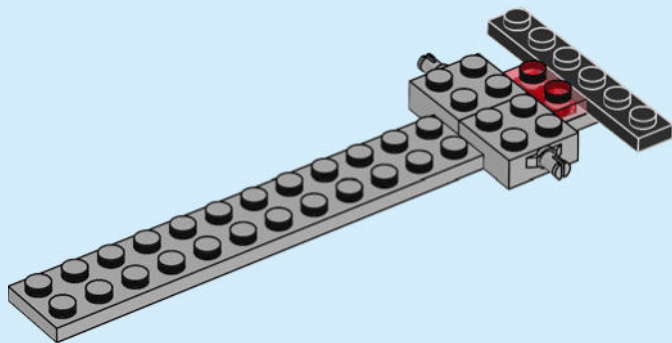

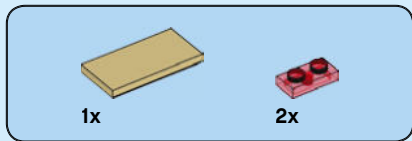

3

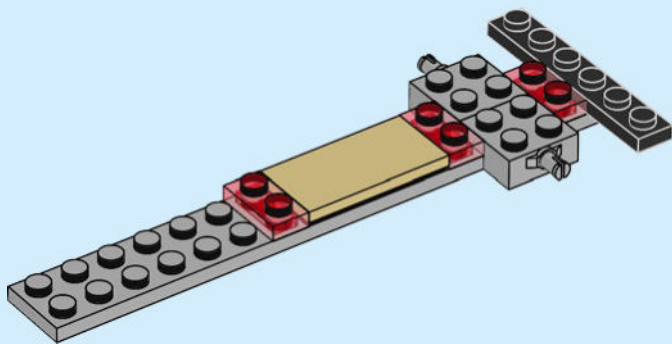

6



2x



1x

4

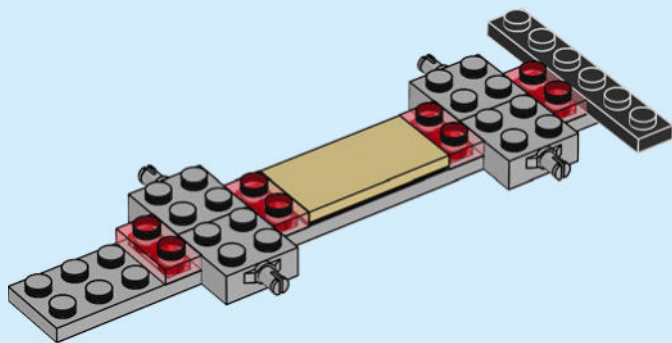



2x

5

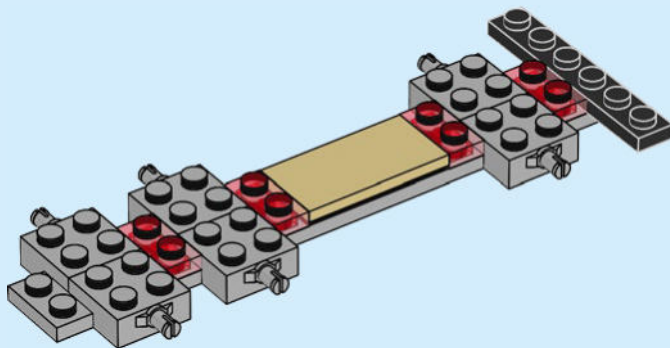

8





1x

6

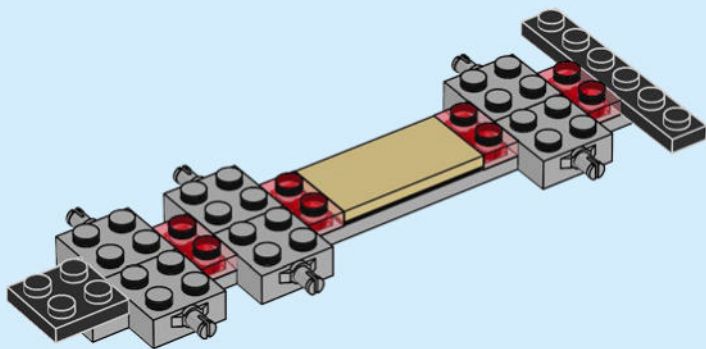

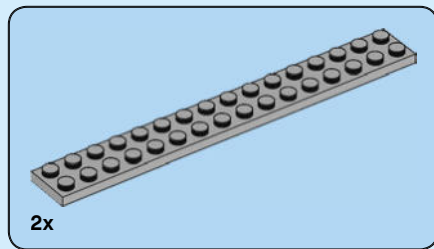

7

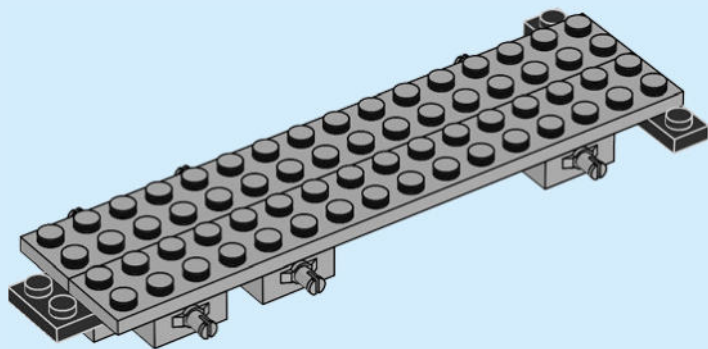



1x

8

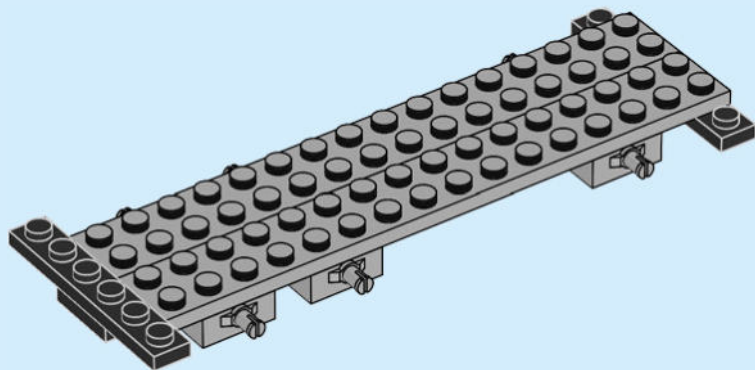

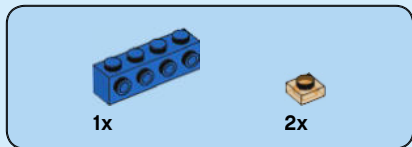

9

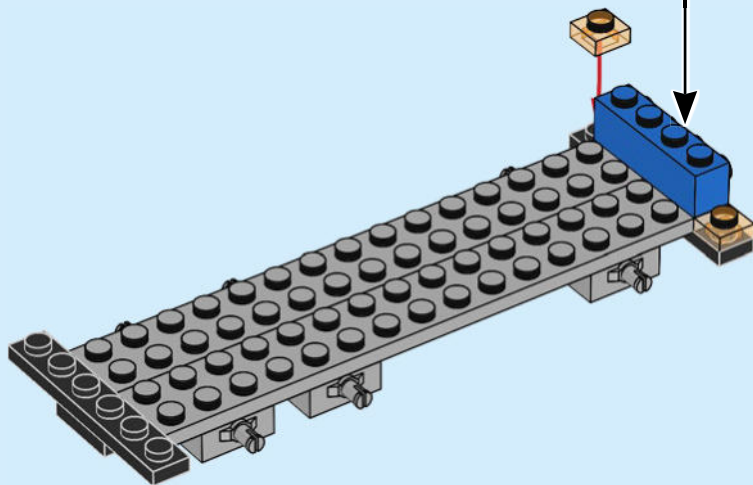
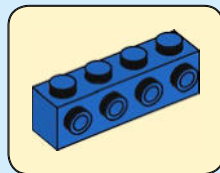

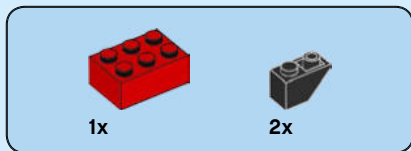

10

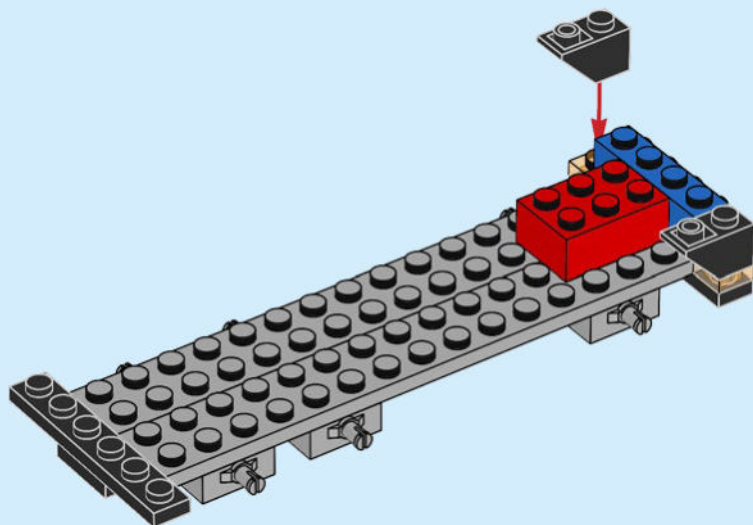



2x

11

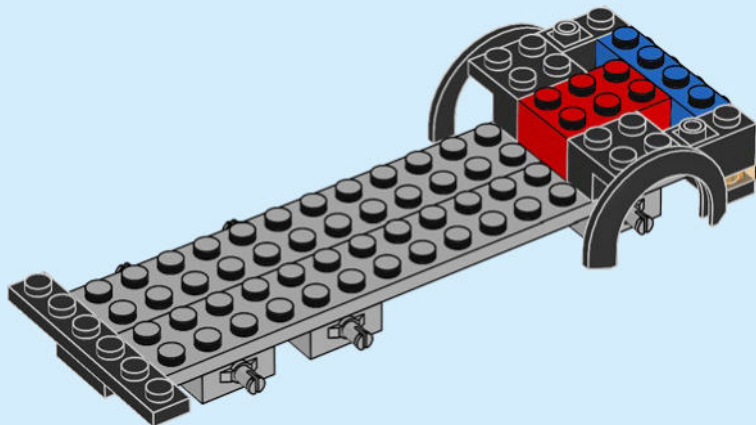

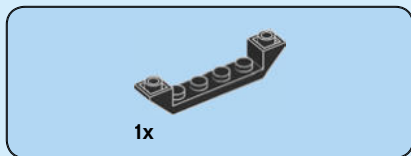

12

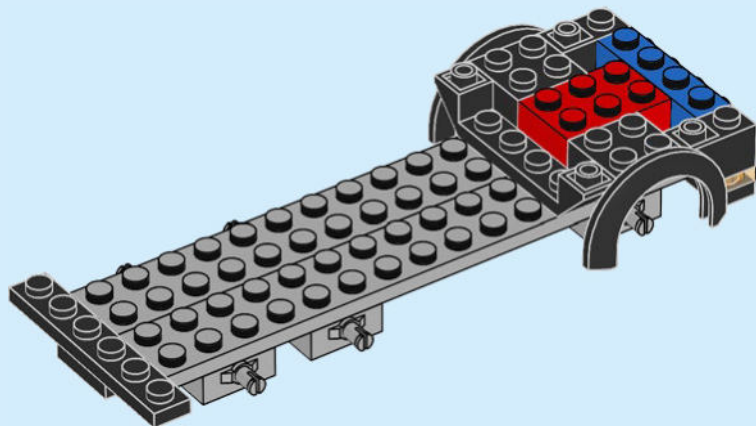



2x

13

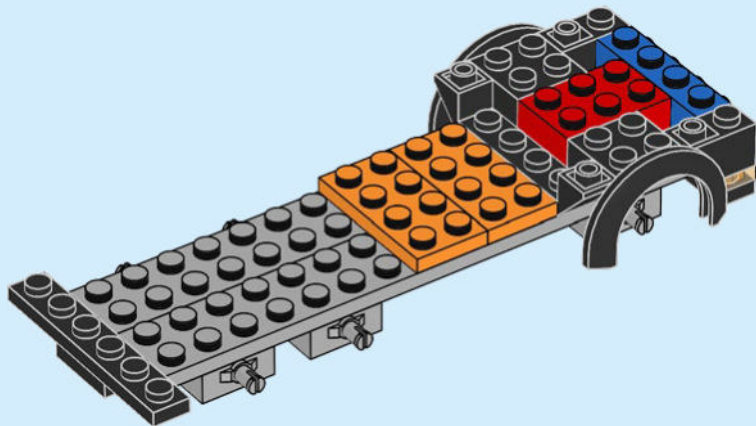





6x

14

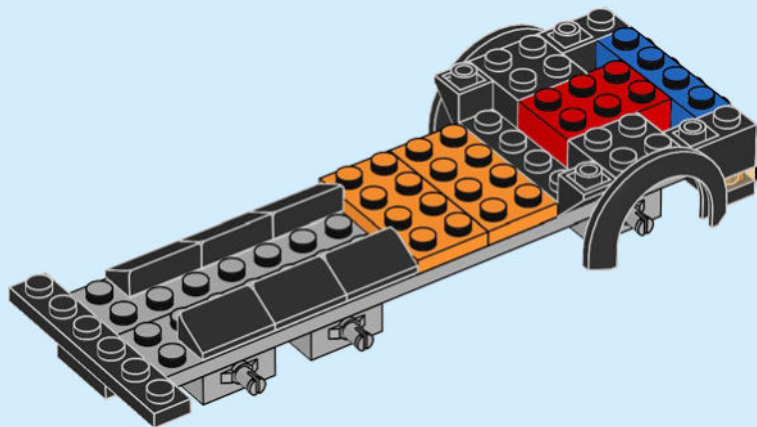



2x

15

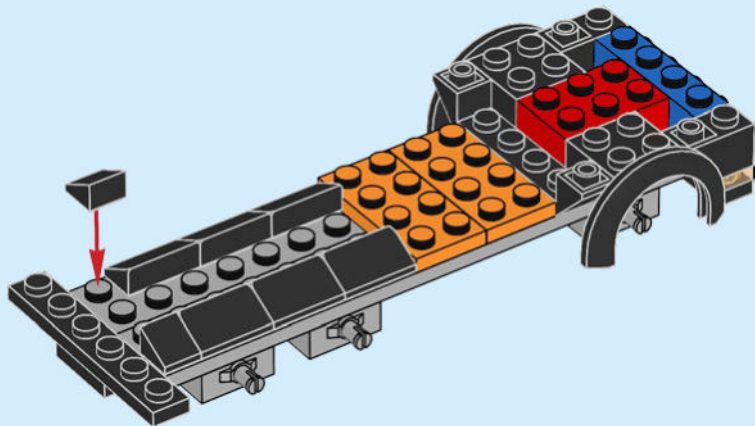



1x



1x

# 16

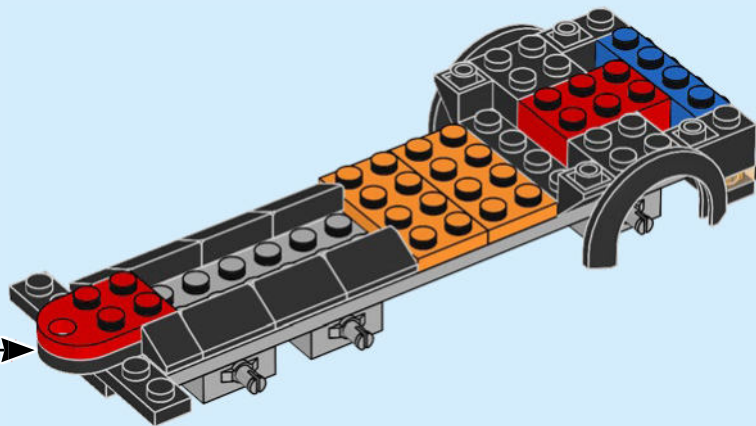
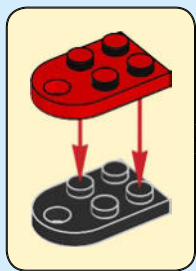



# 17

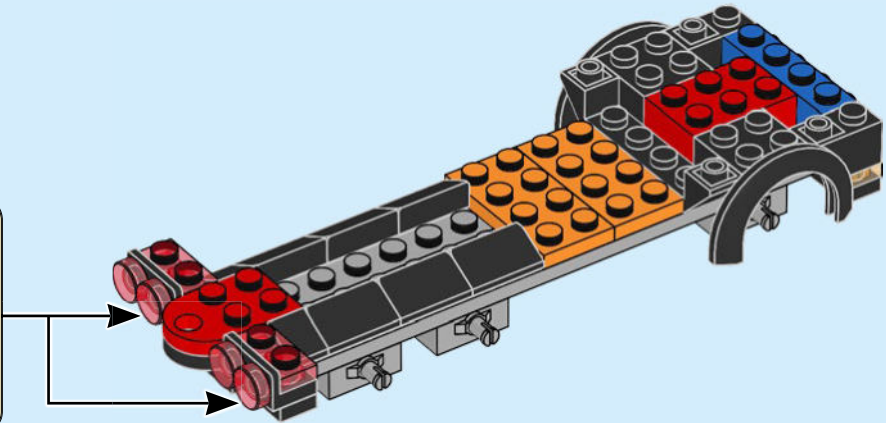
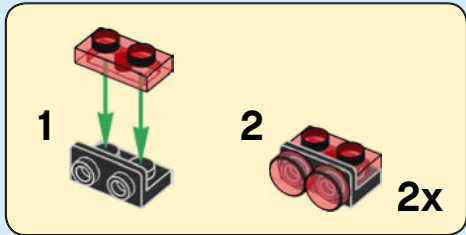



4x

18

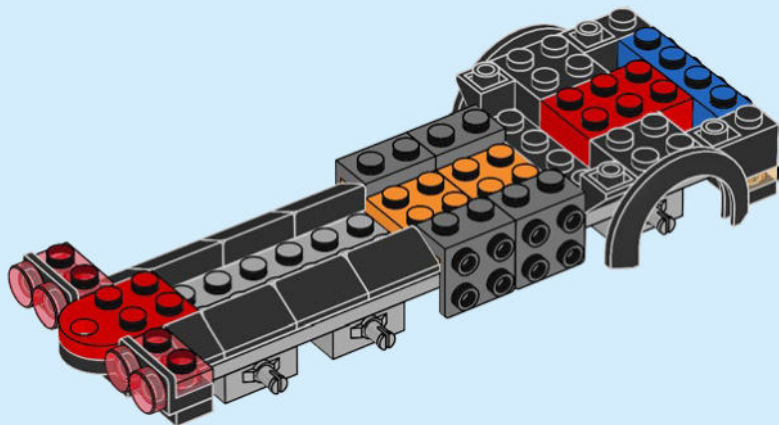

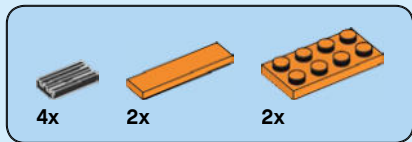

19

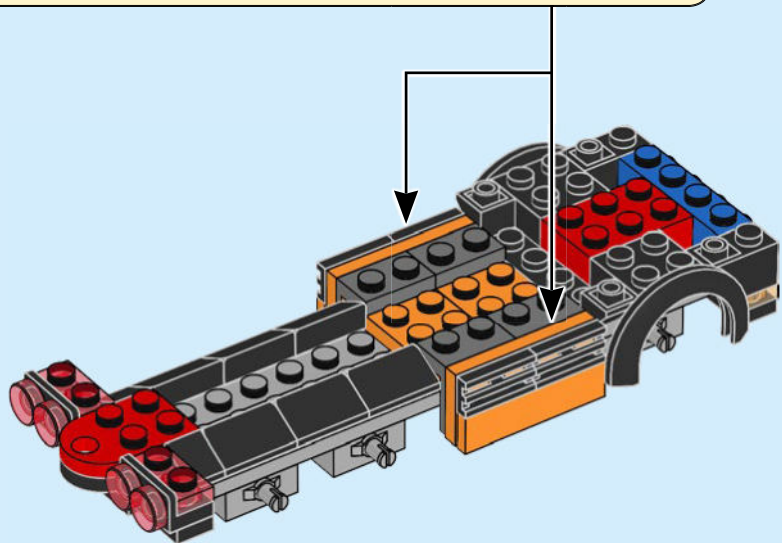
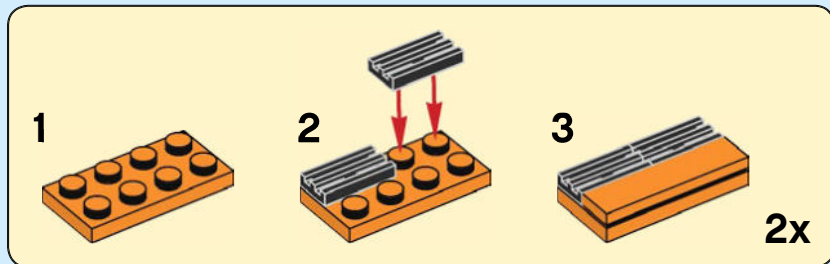

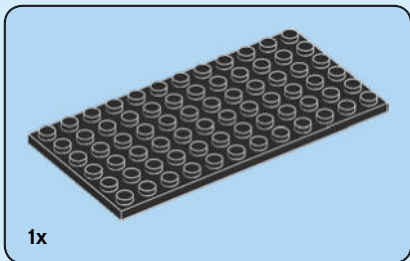

20

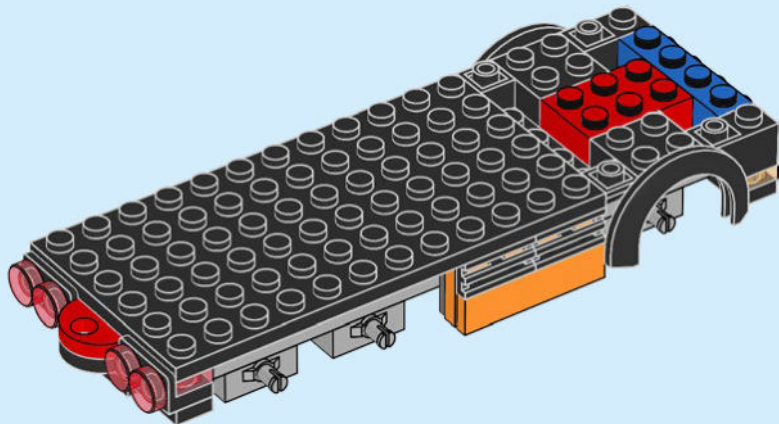

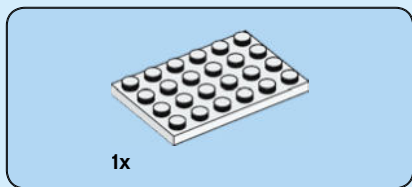
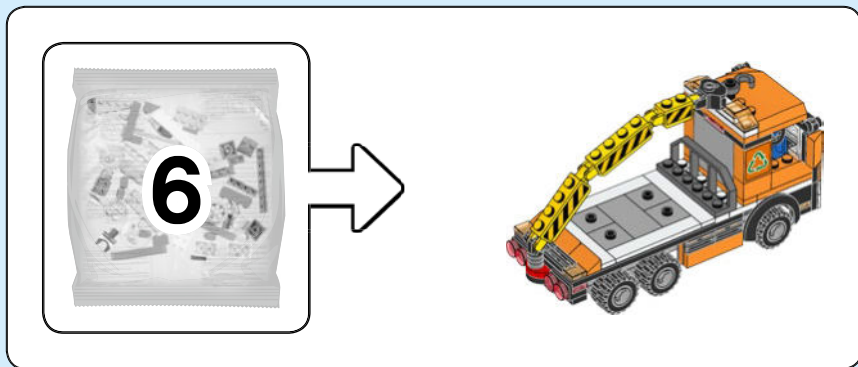

21

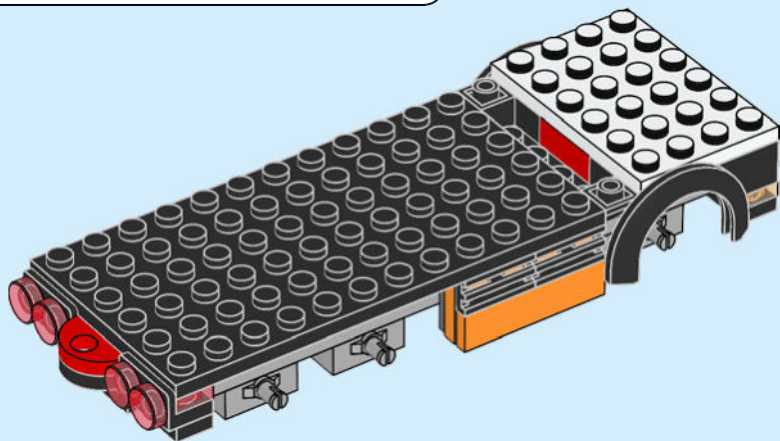



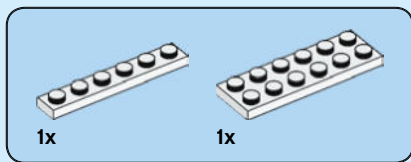

22

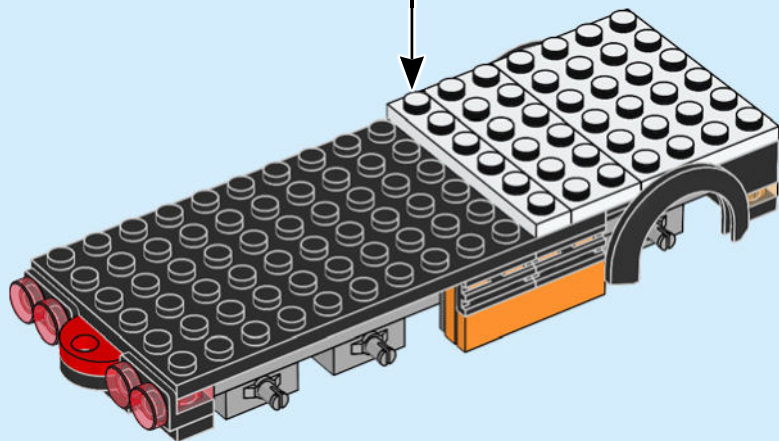
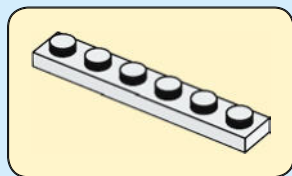



4x

23

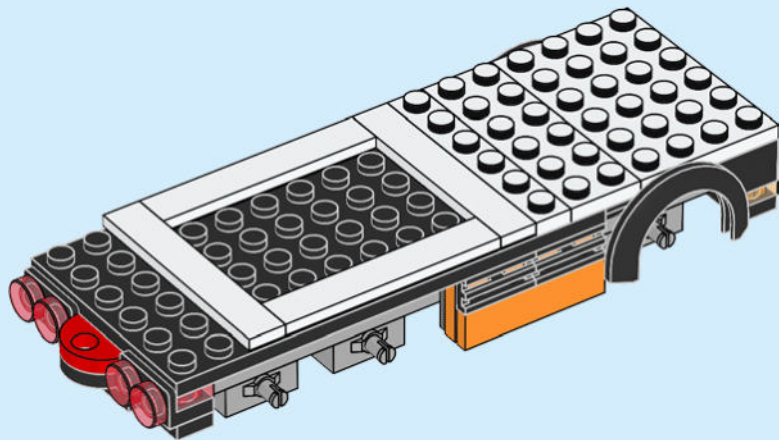

26

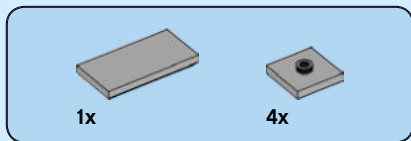

24

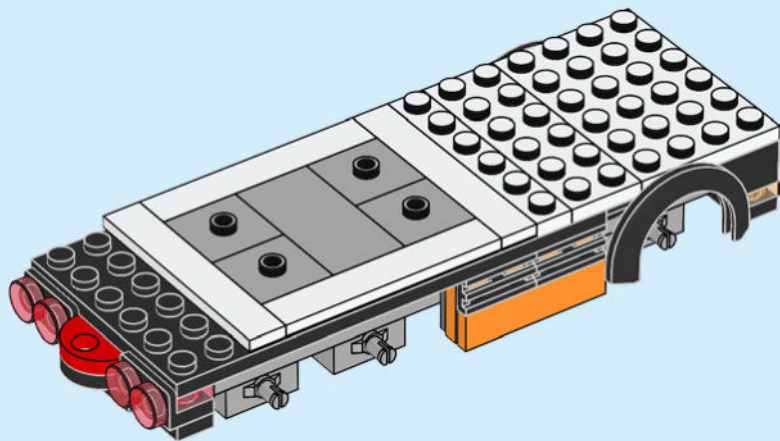



3x

25

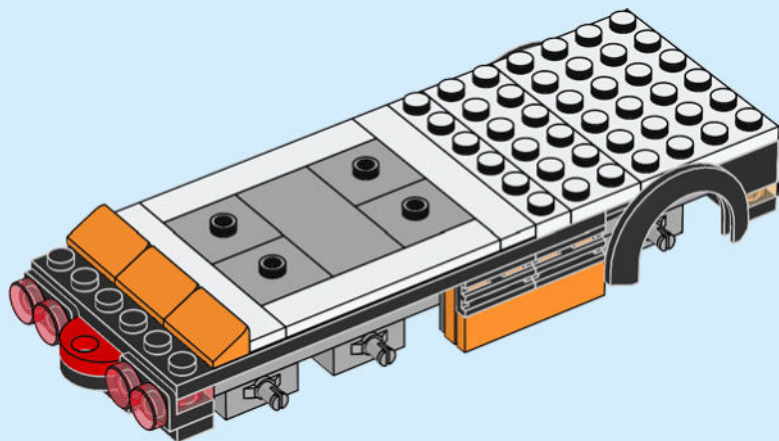



2x



2x

# 26

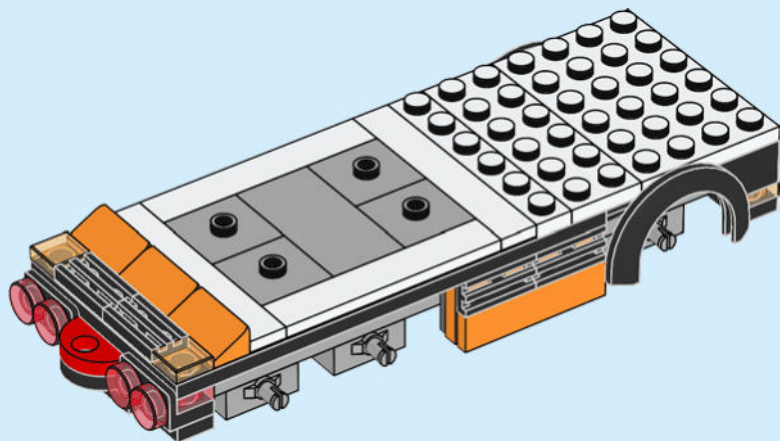

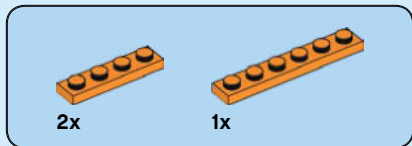

27

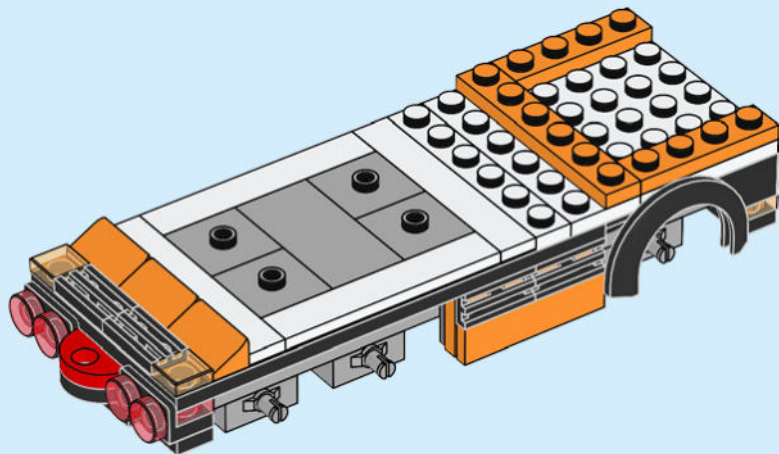



1x



1x

# 28

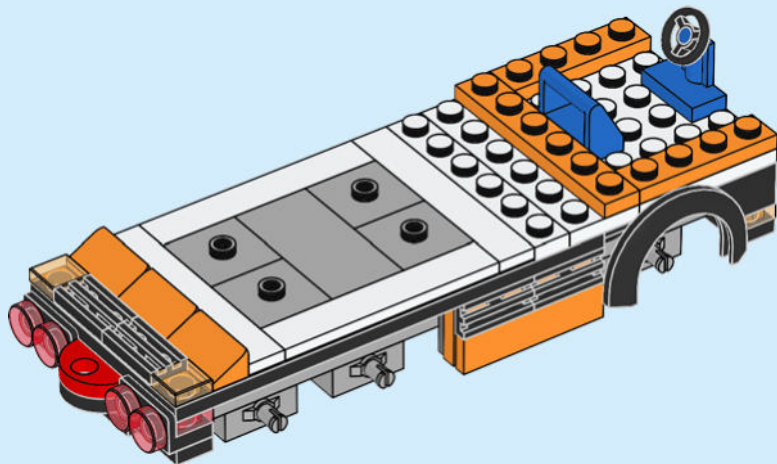



2x



2x

# 29

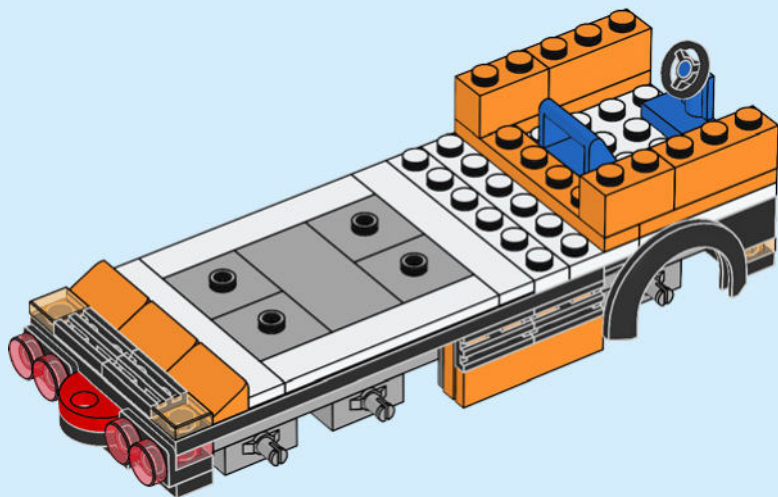



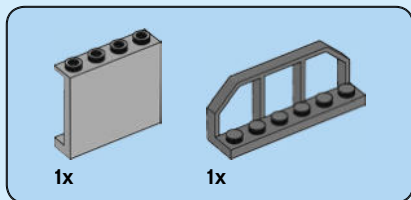

30

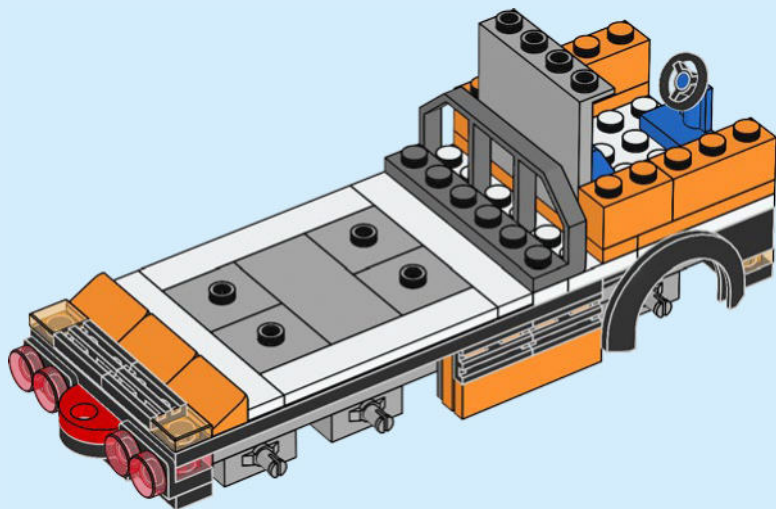



1x

31

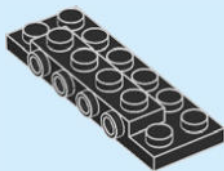

34



2x

32

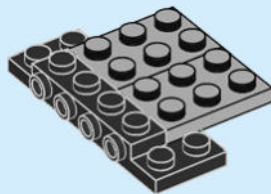

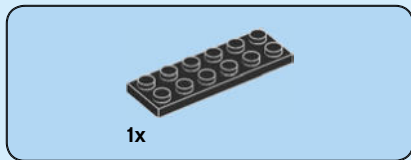

**33**

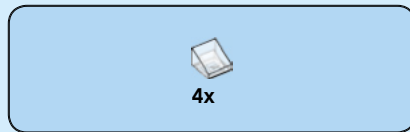
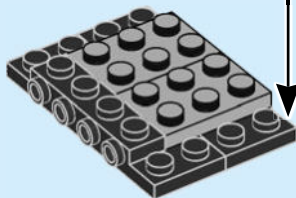
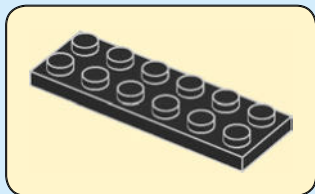

**34**

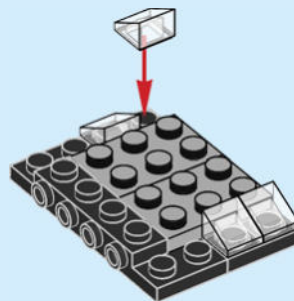



2x

35

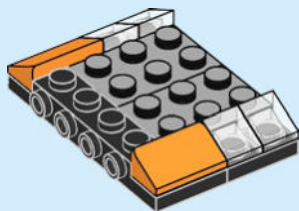

36



1x

36

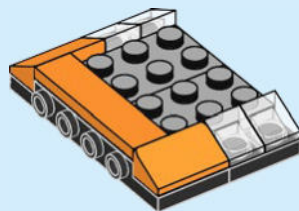

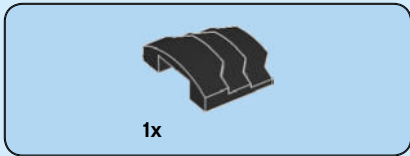

37

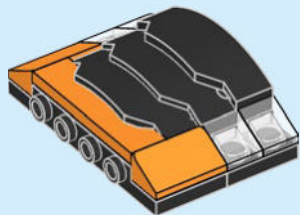

38

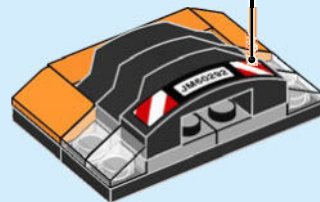
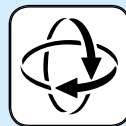

39

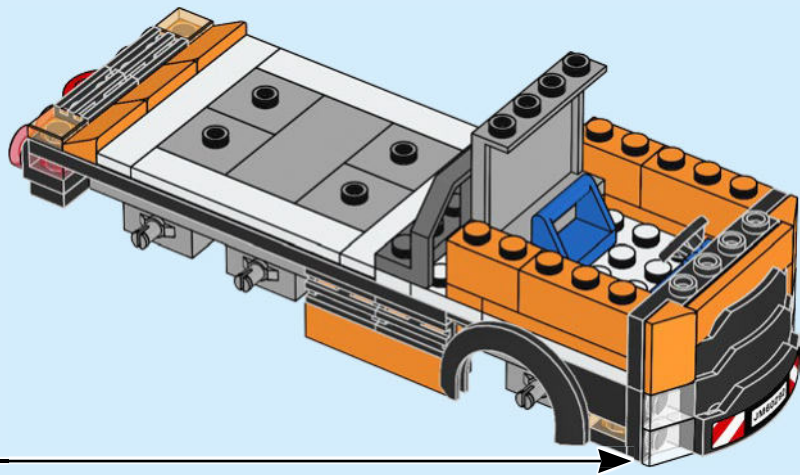

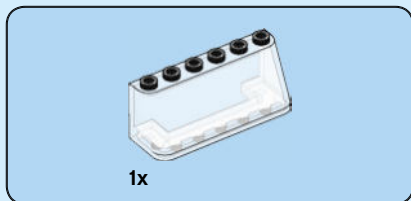

40

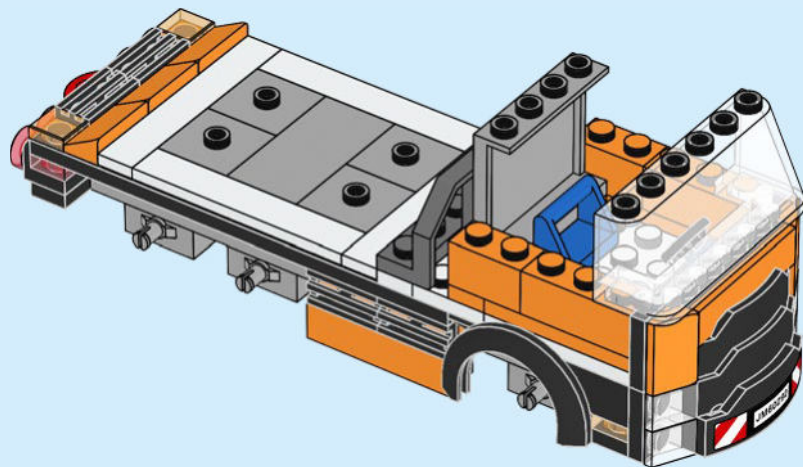

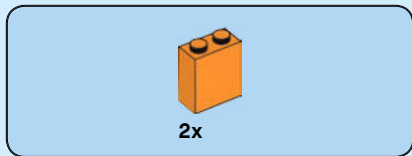

41

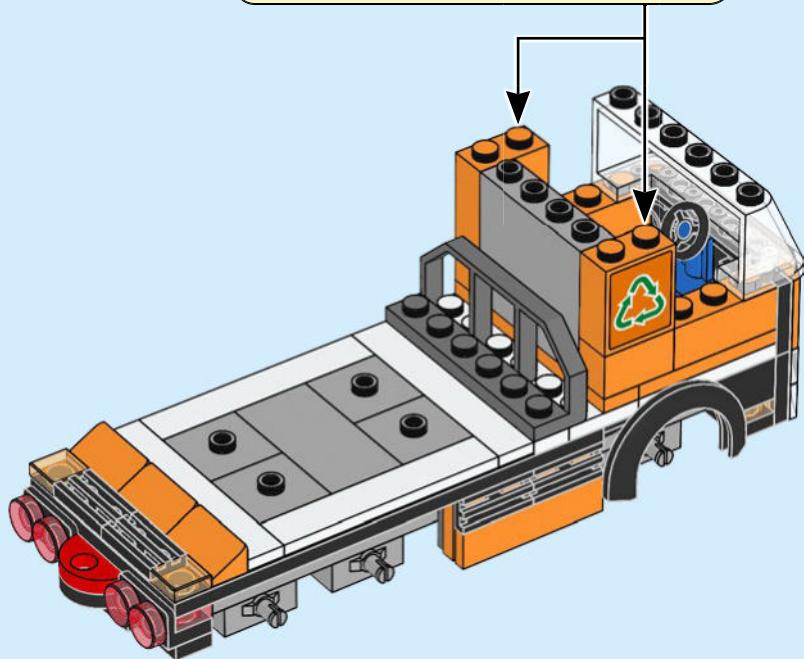
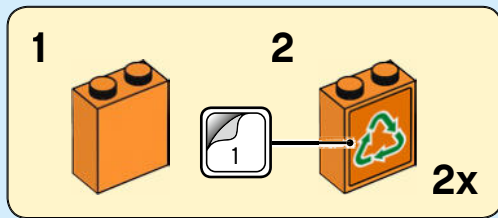





42

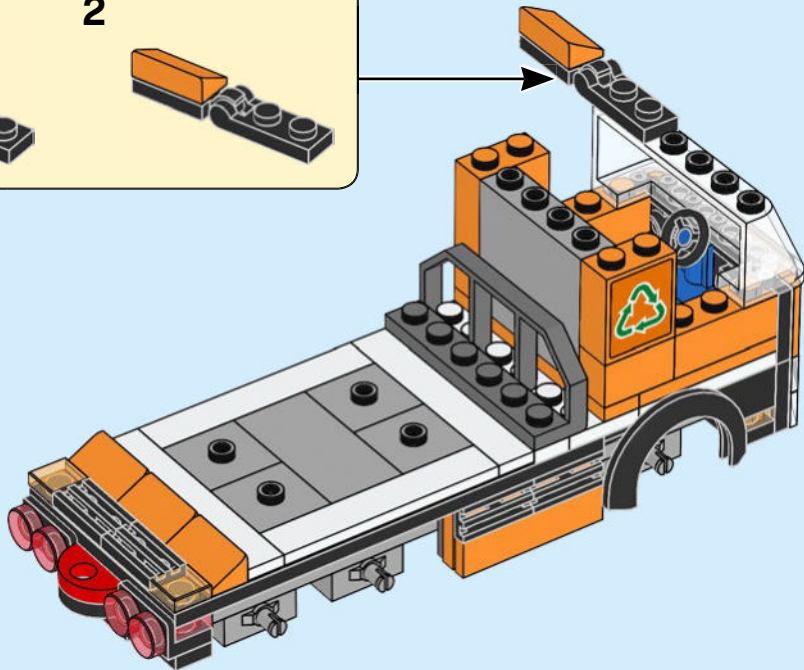
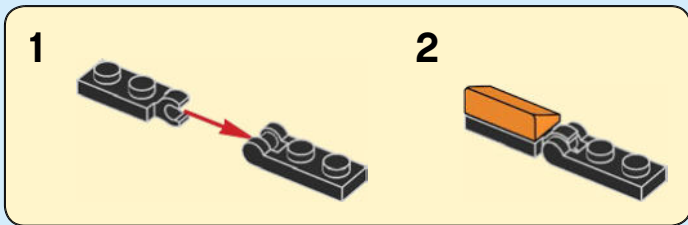

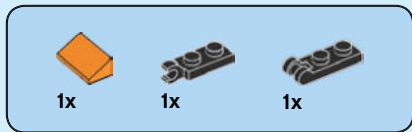

43

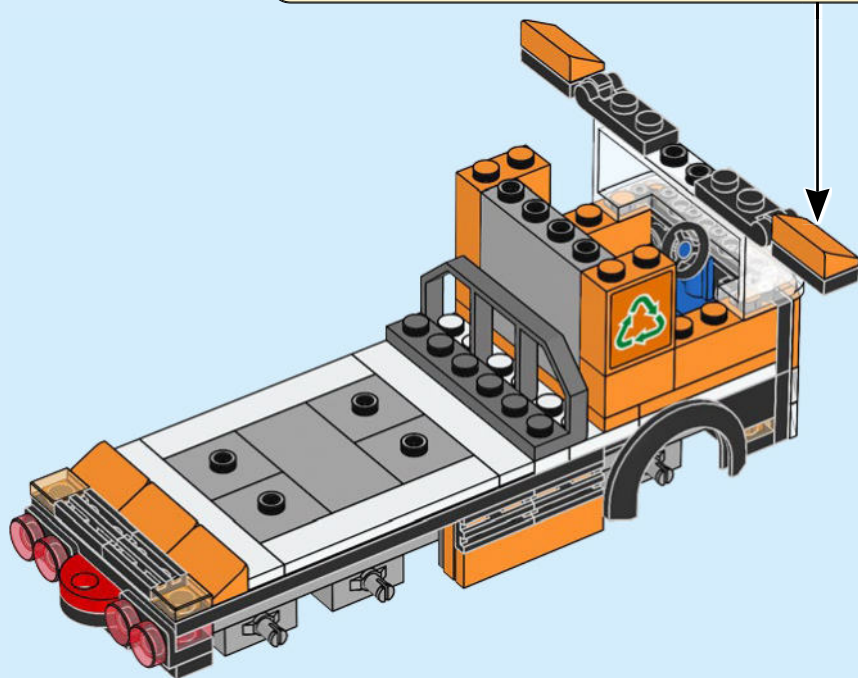
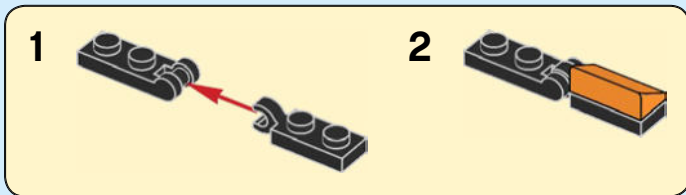



2x



1x



1x

# 44

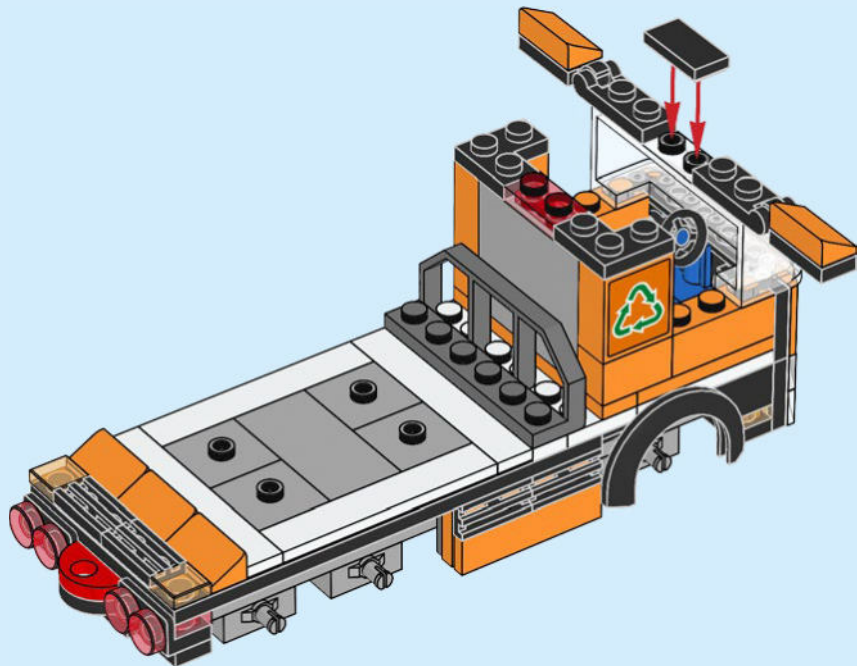

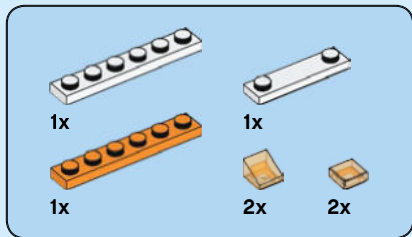

45

1

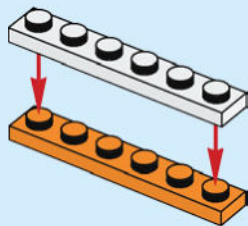

2

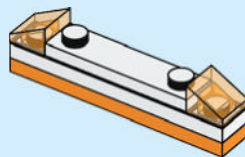

3

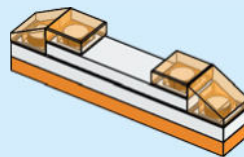

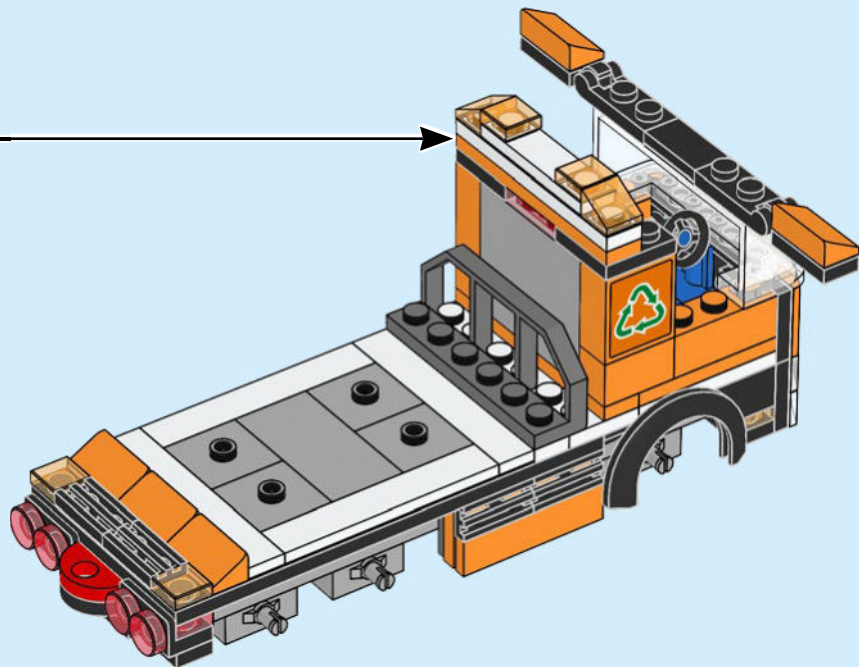

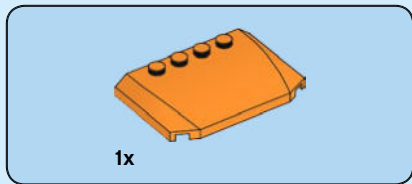

46

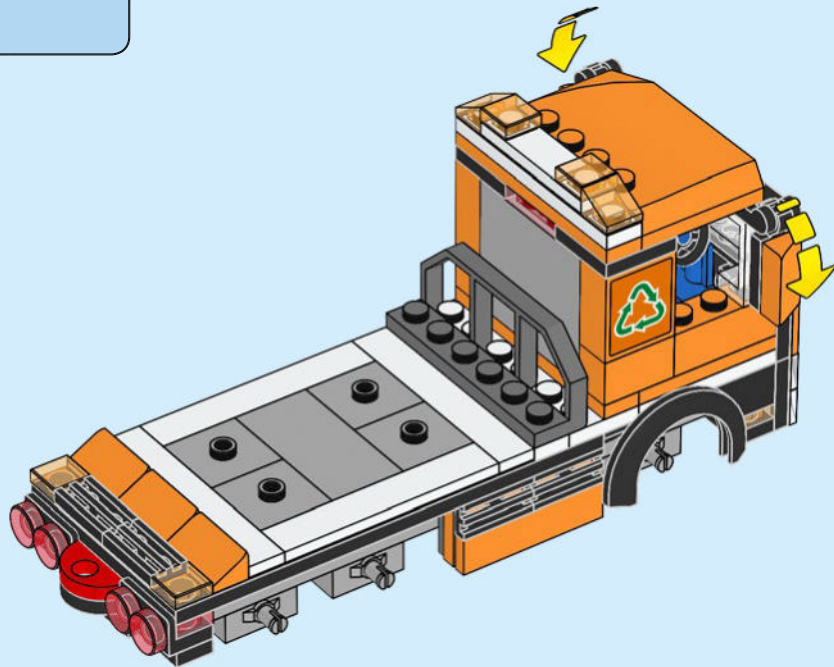



47

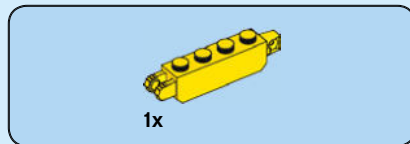
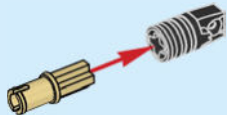

48

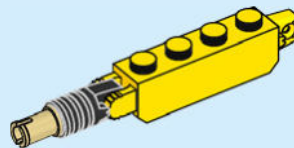

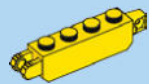

1x

49

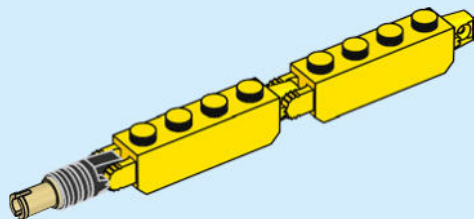

48



1x

50

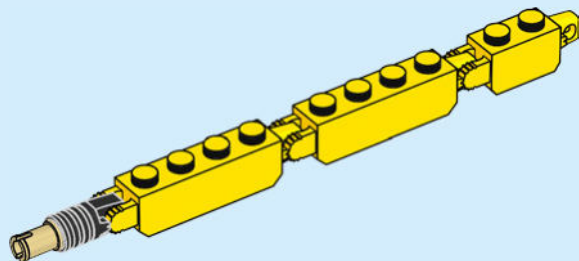



51

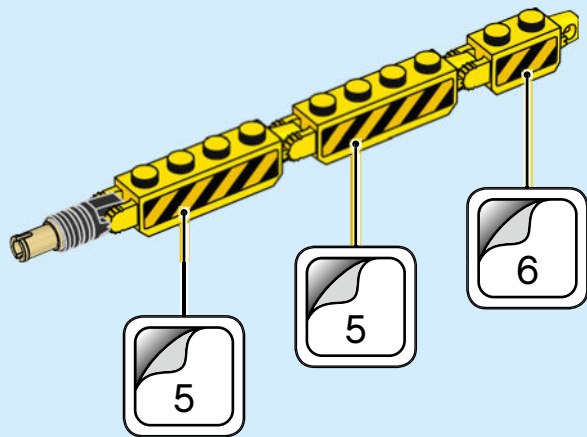

52

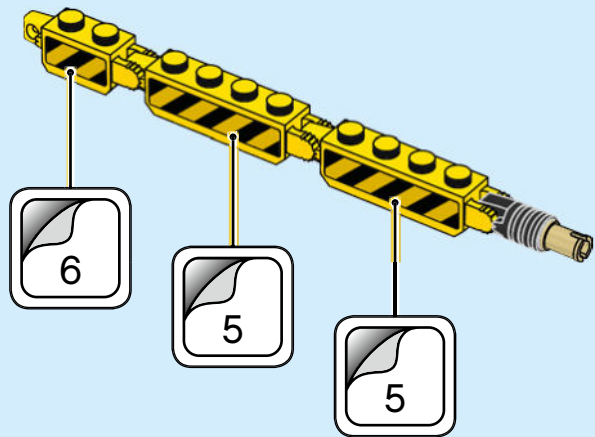



1x



1x

# 53

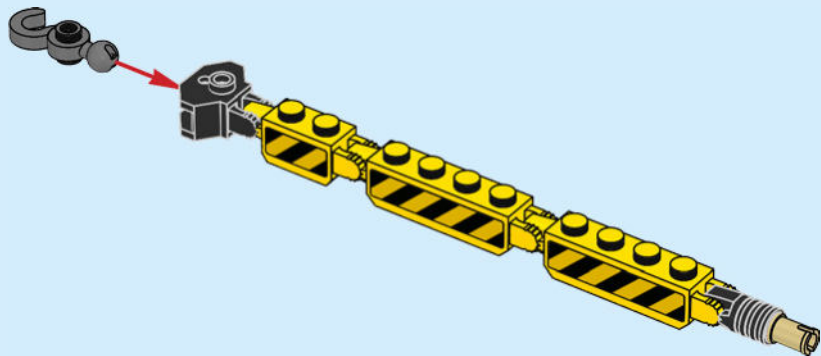

54

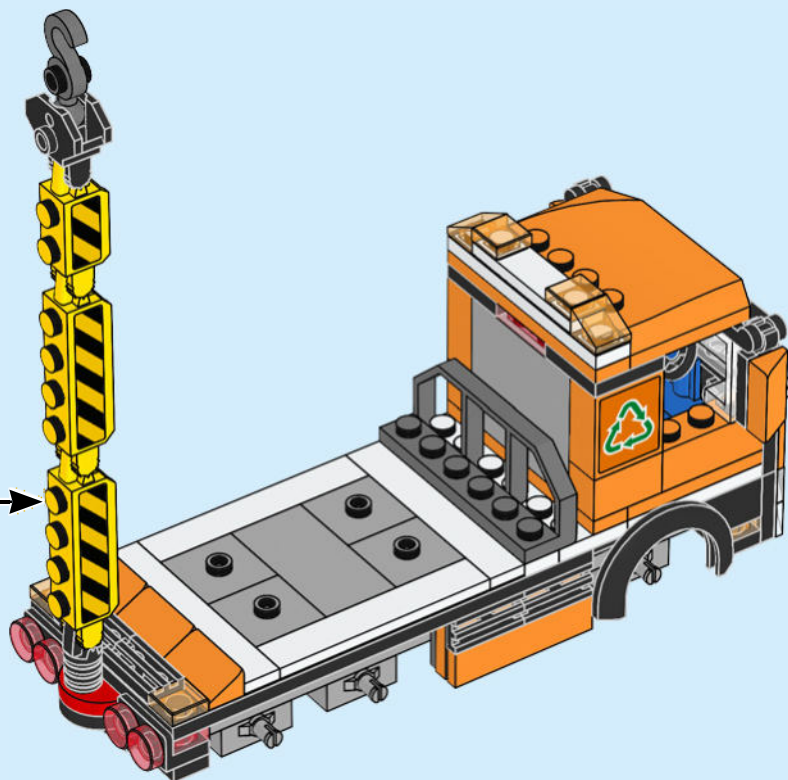

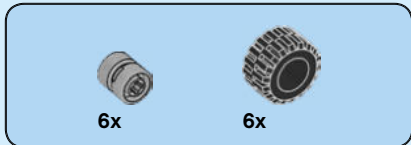

55

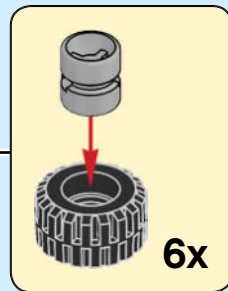
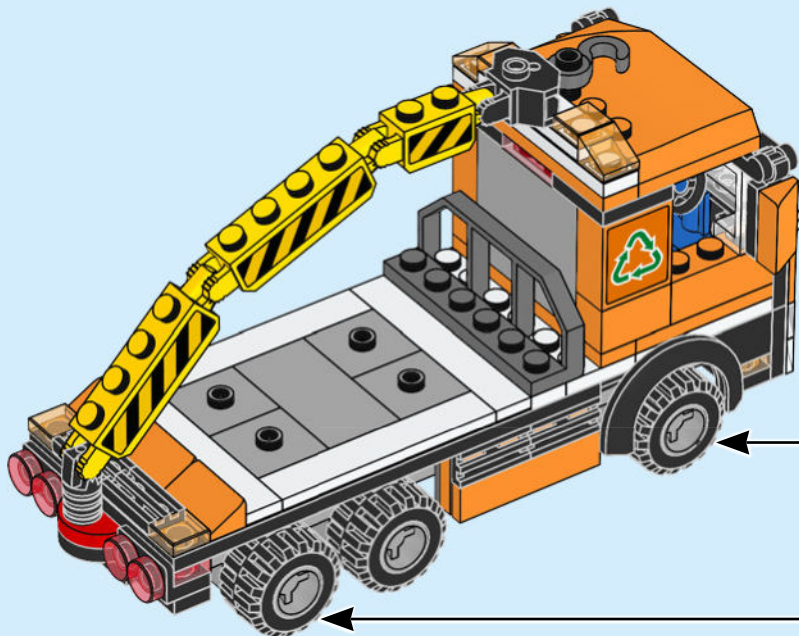

52



# CITY

60292



4



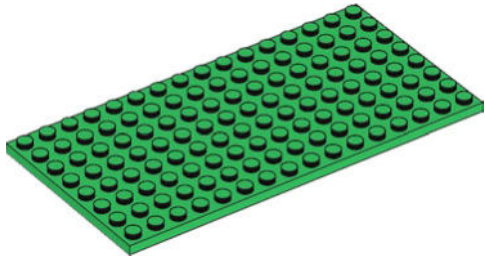

1x

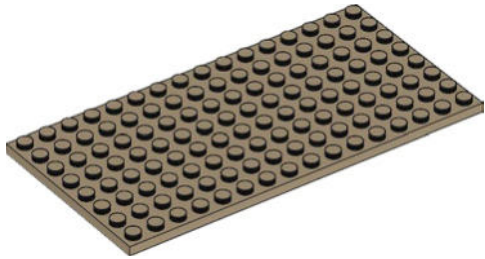
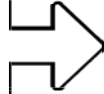

1x

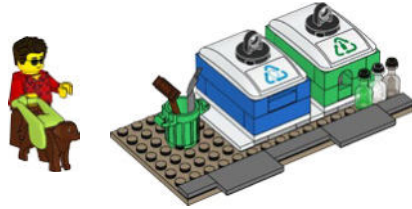
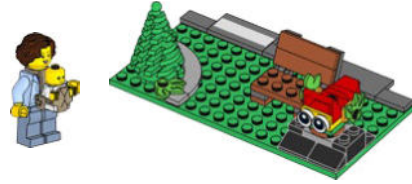

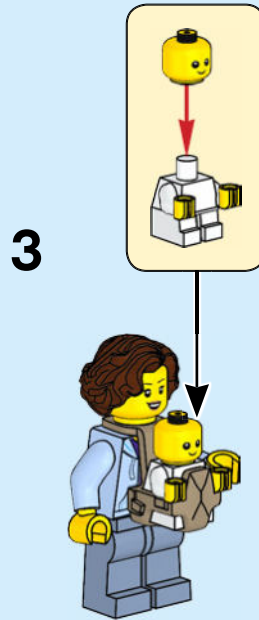
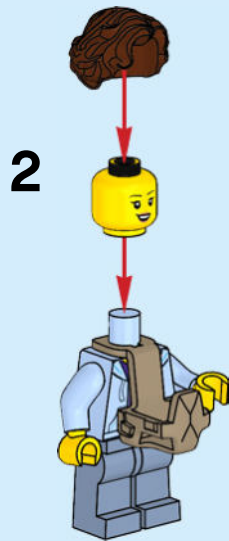
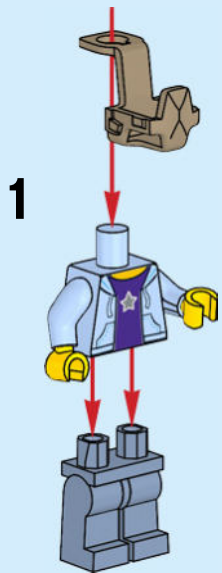

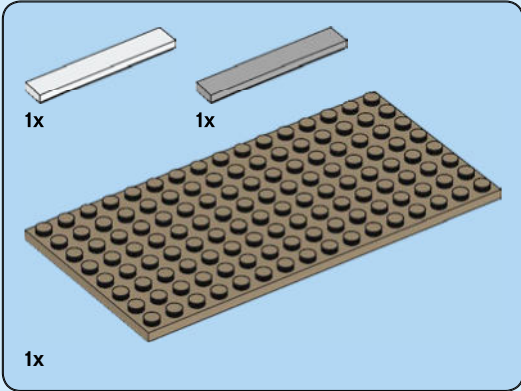
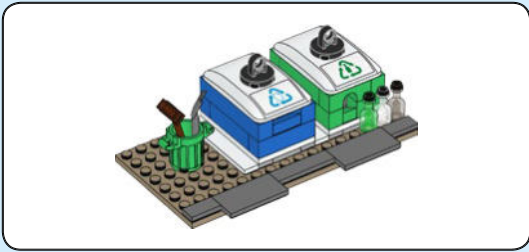

1

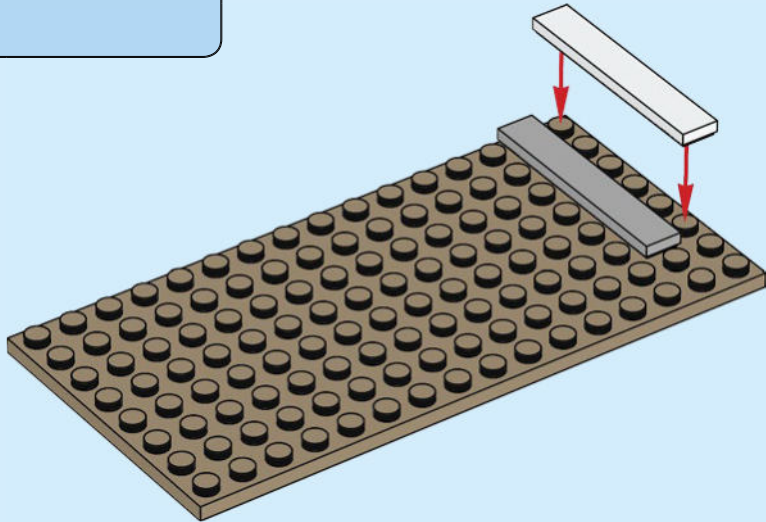



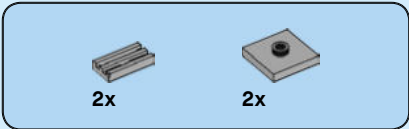

2

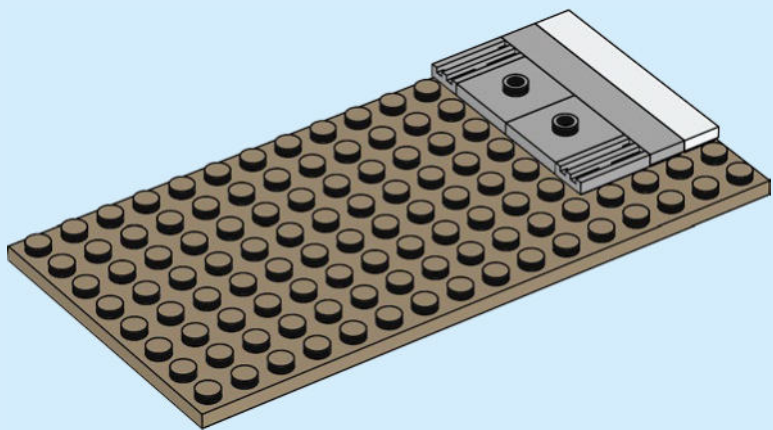

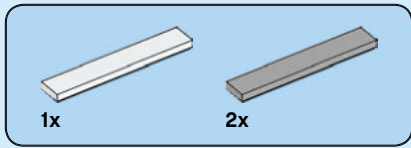

**3**

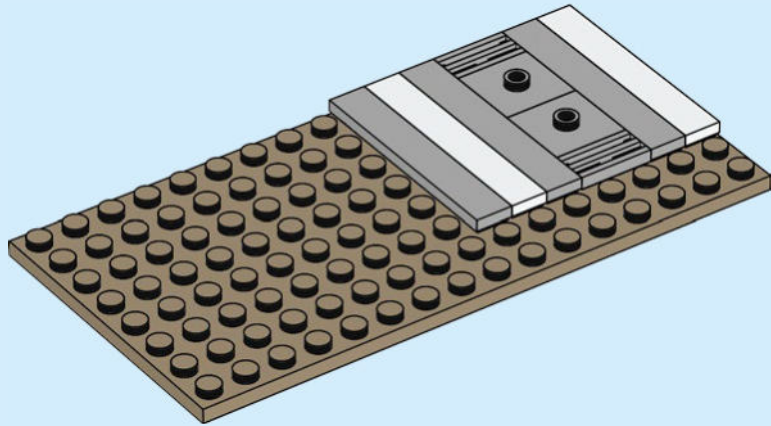

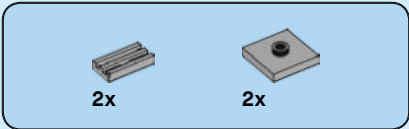

4

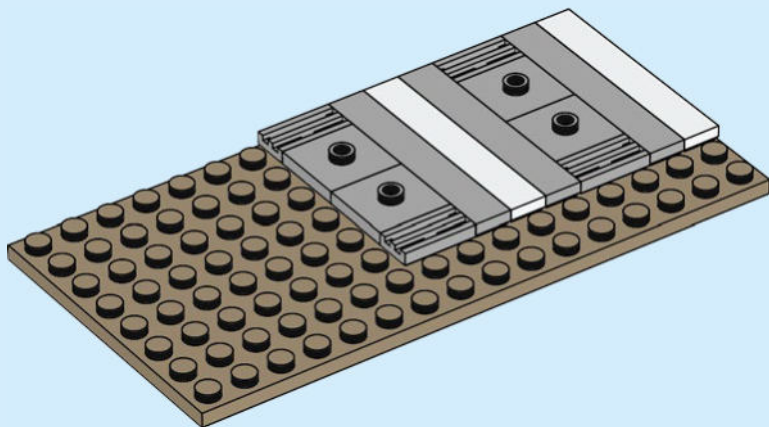

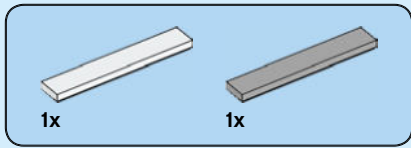

5

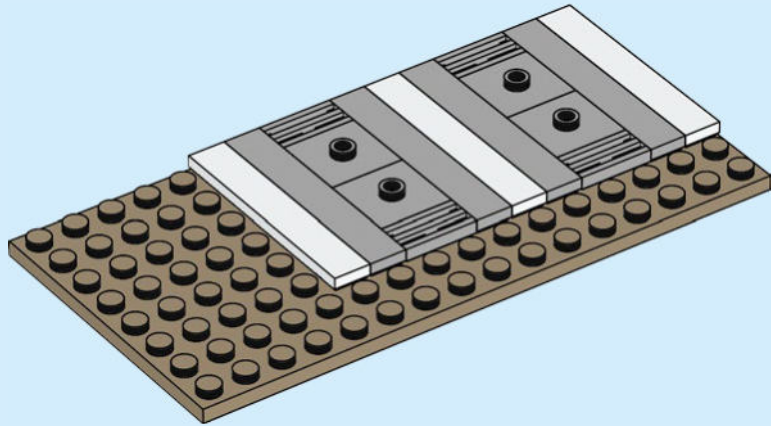

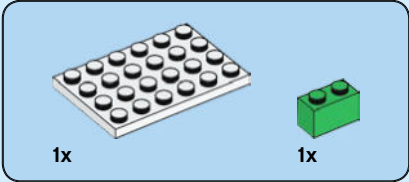

6

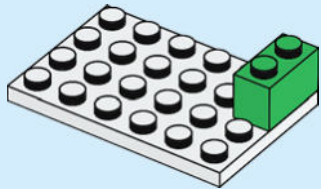

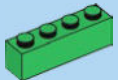

1x

7

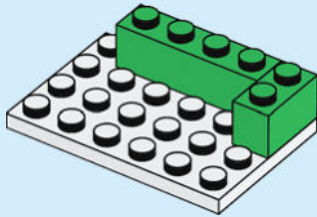

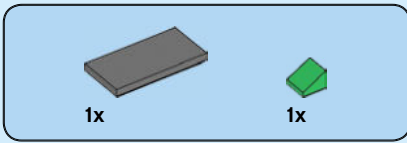

8

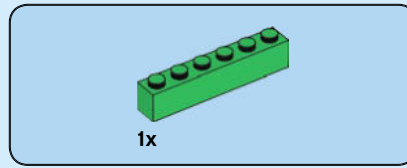
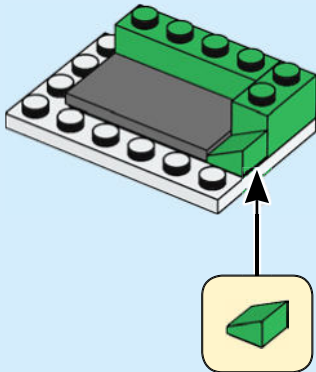

9

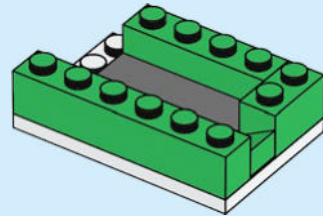

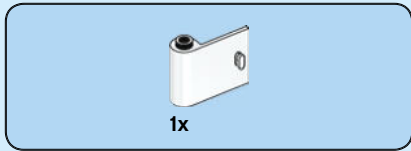

10

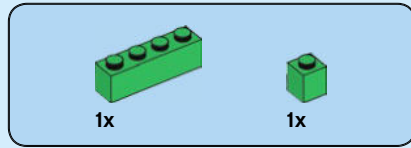
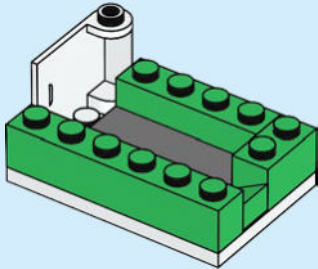

11

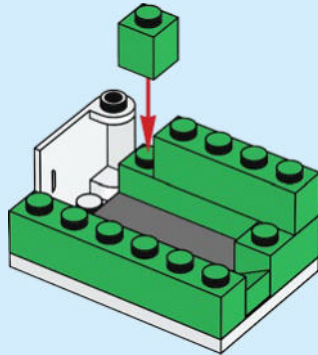



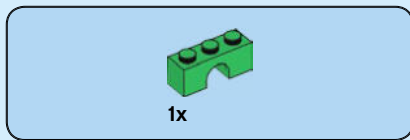

12

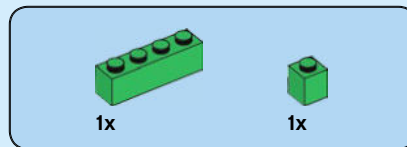
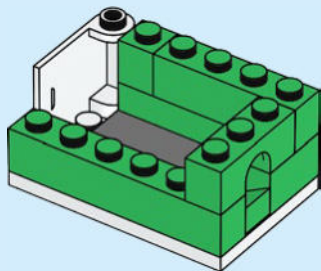

13

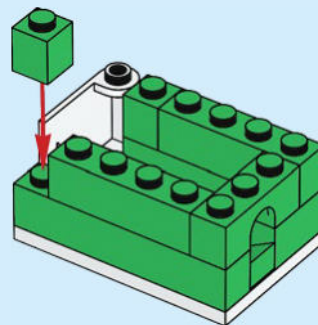

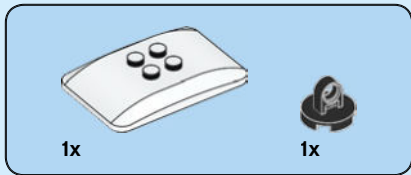

14

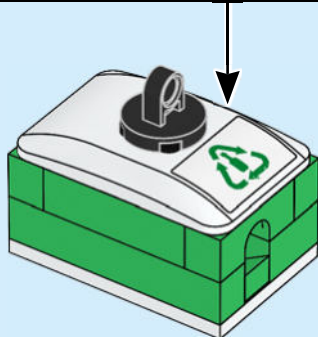
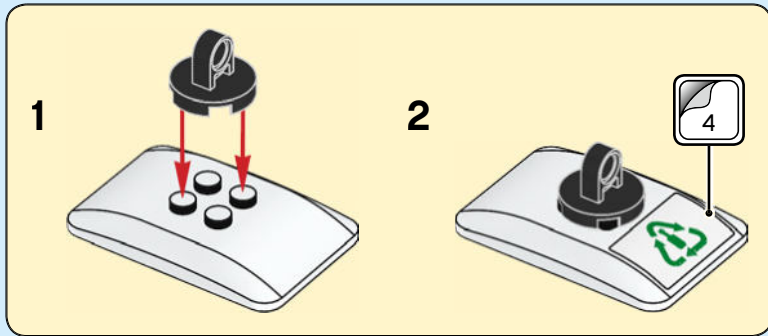

15

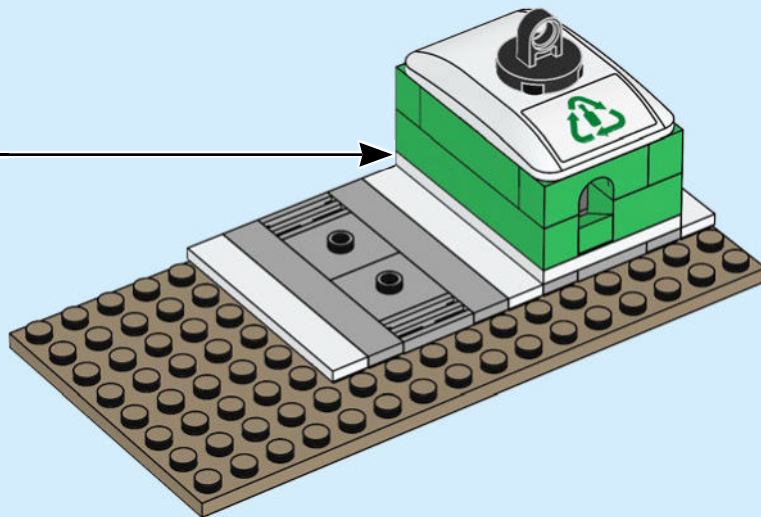

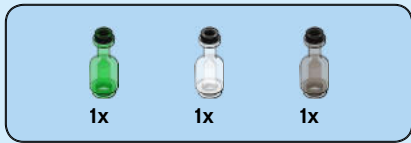

16

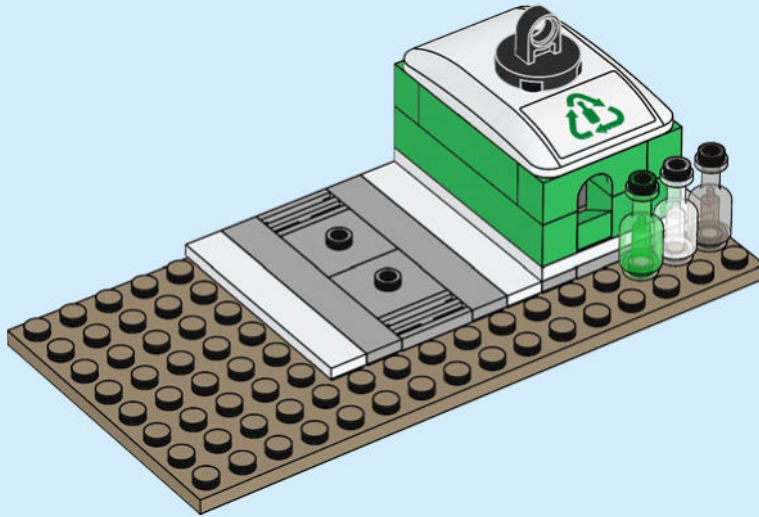

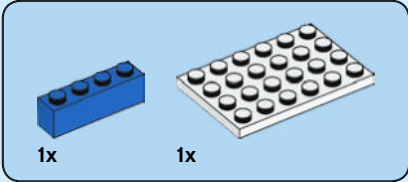

17

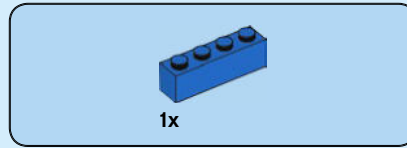
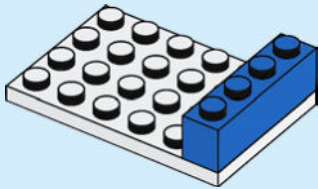

18

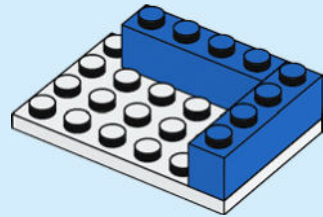

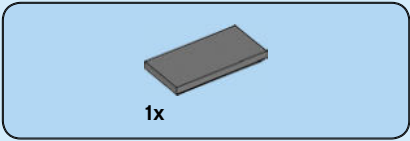

19

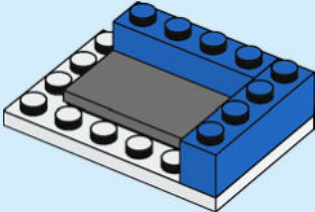

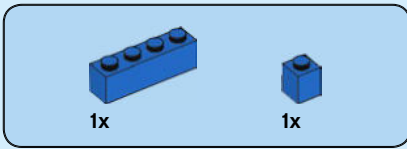

20

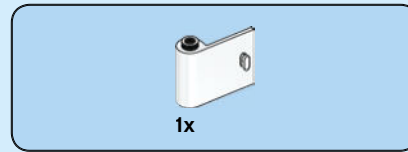
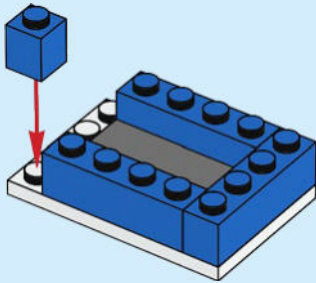

21

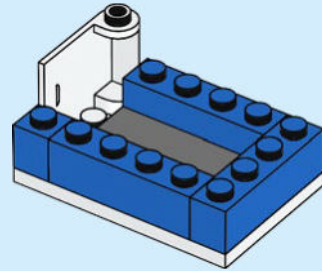

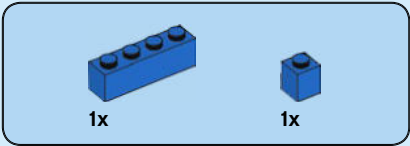

22

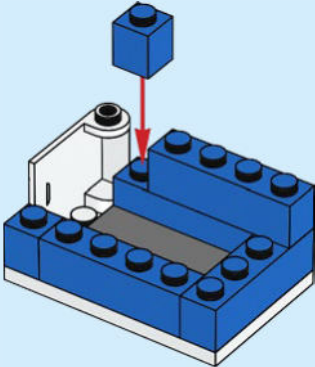





23

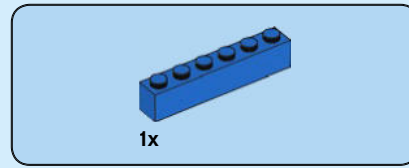
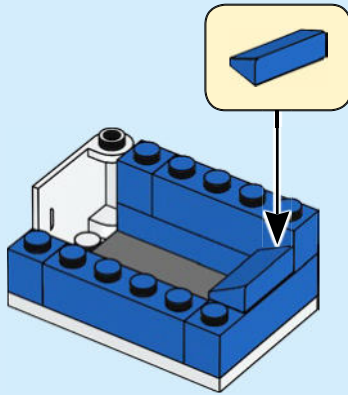

24

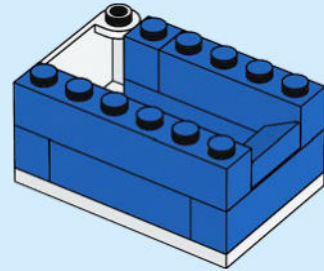

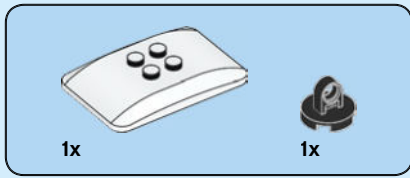

25

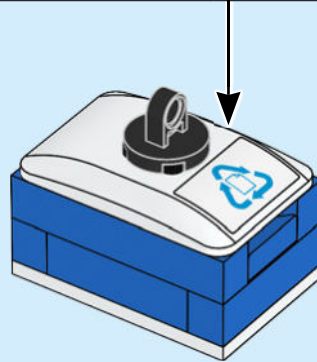
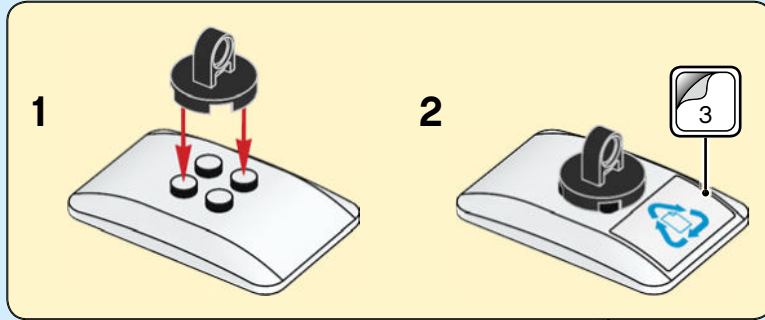

26

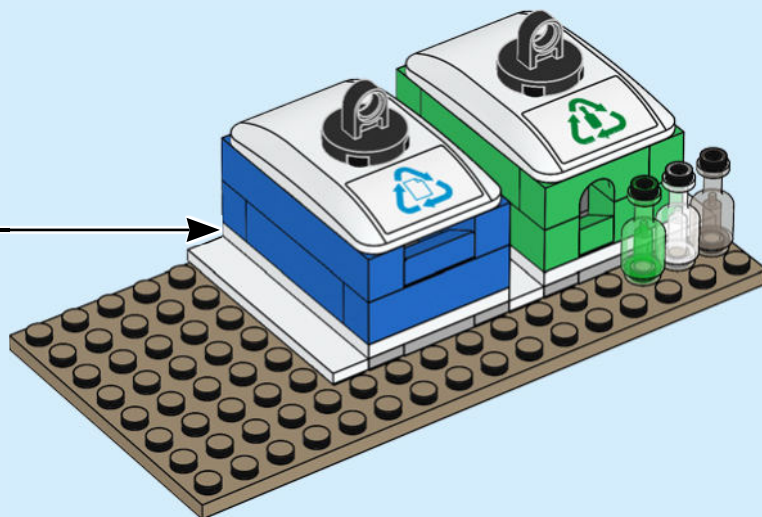

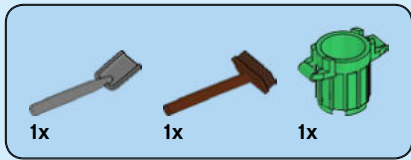

27

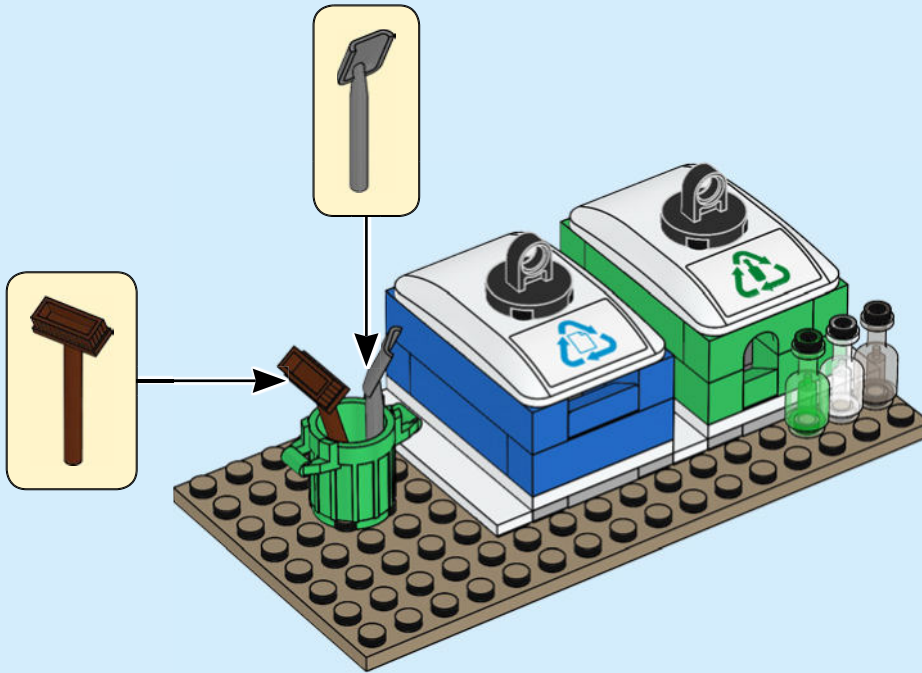

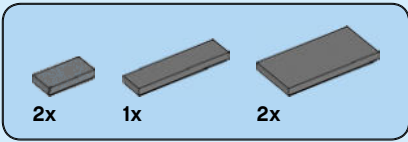

28

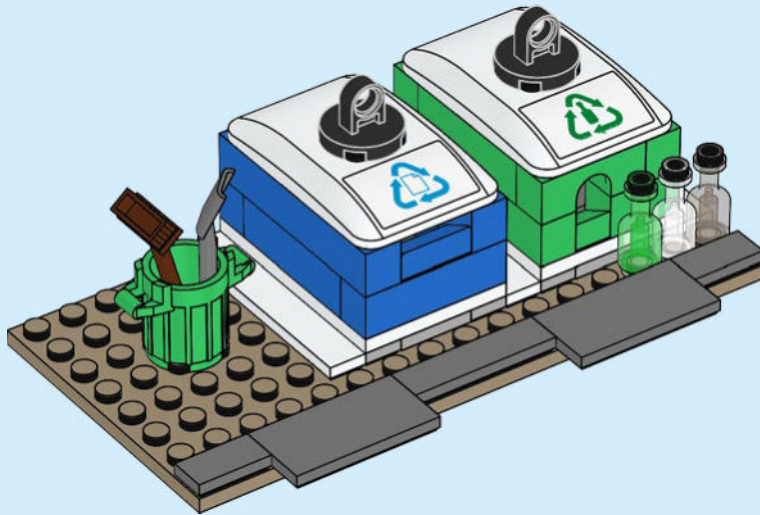

29

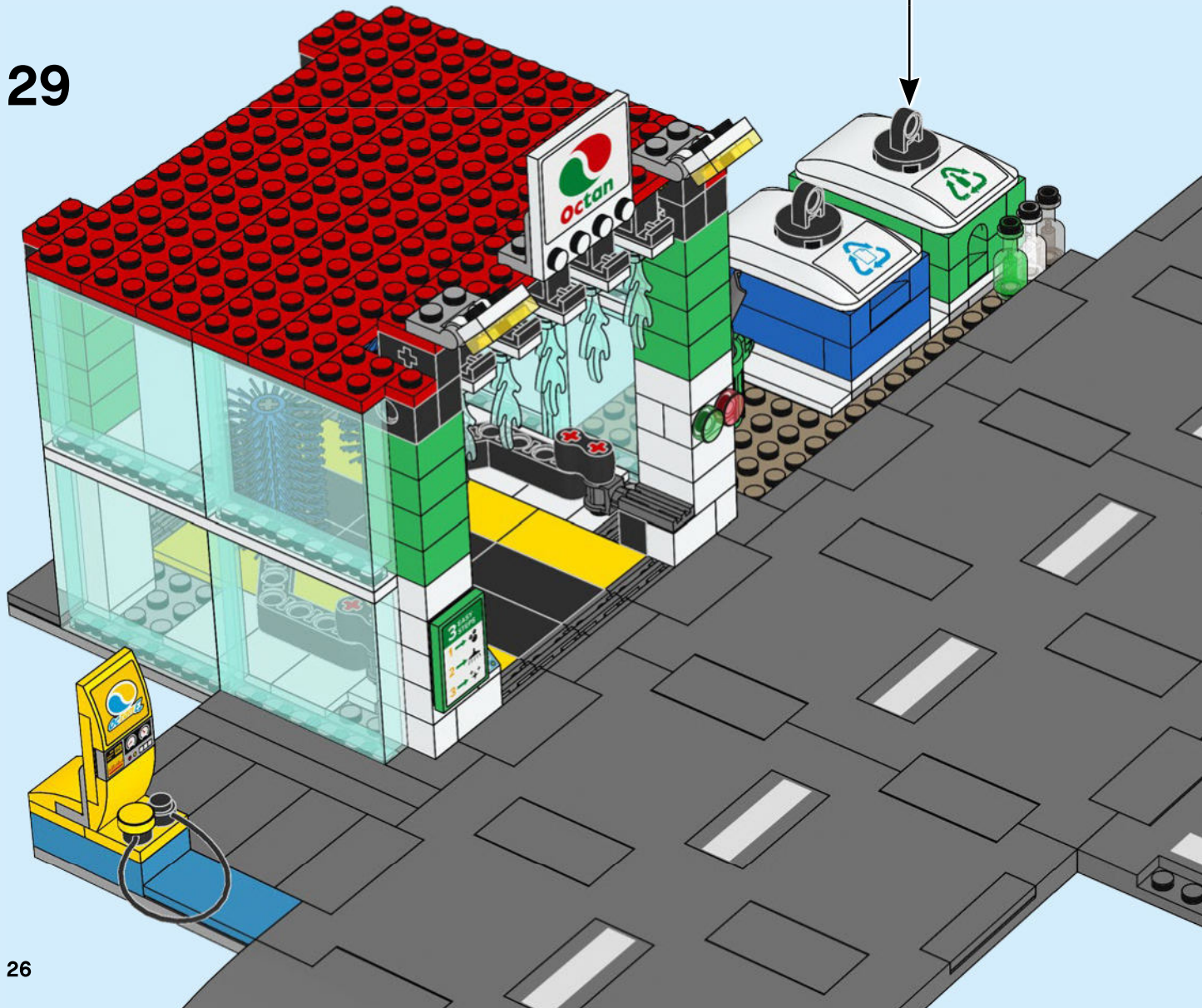



3x



30

3x



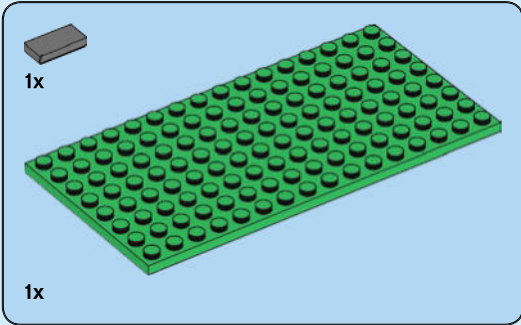
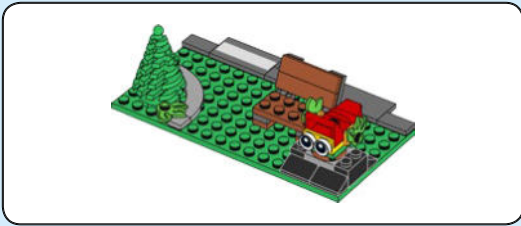

**1**

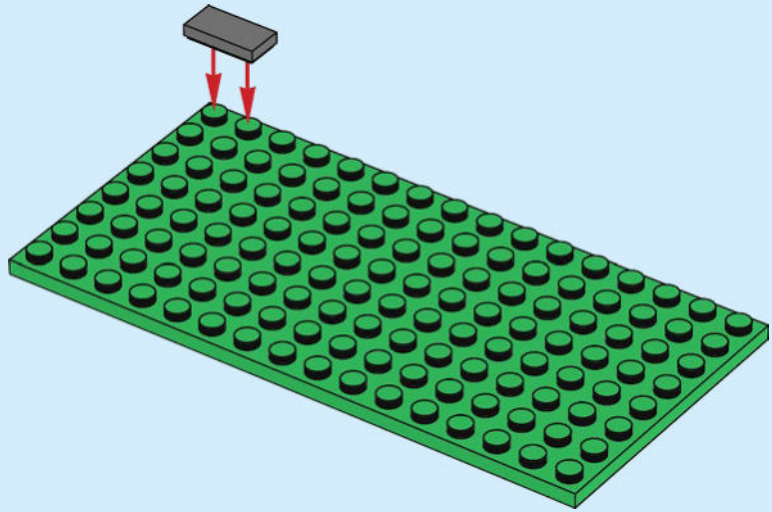



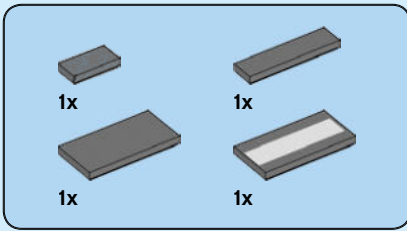

**2**

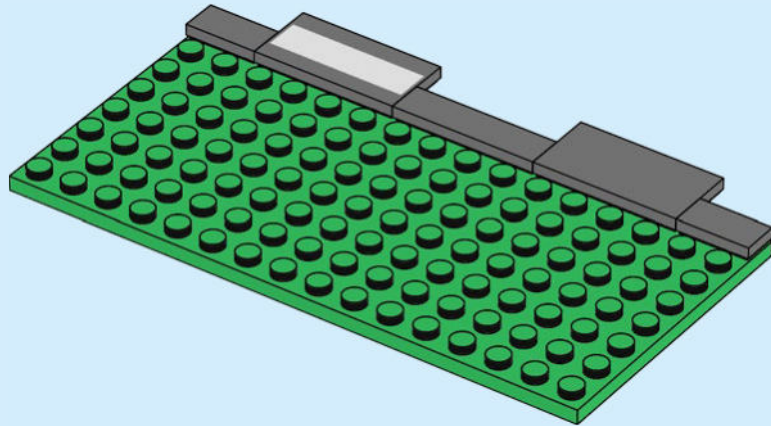



2x

3

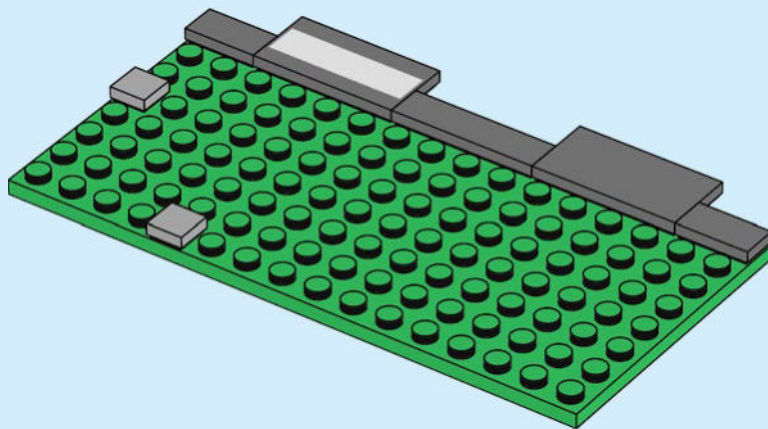

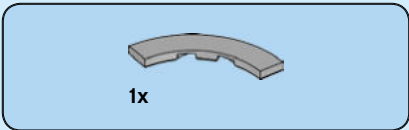

4

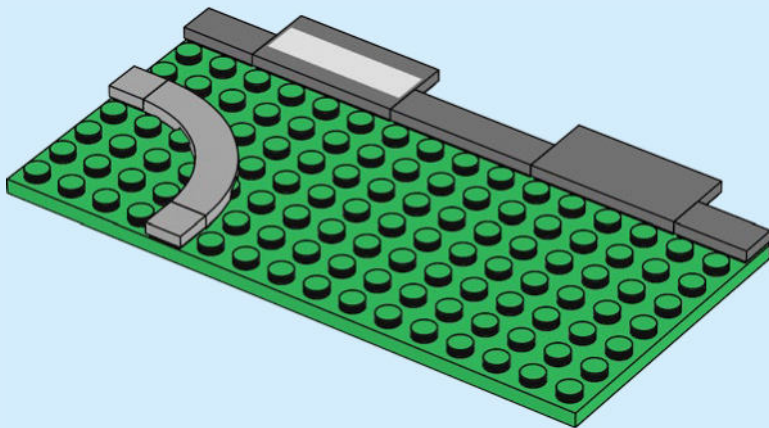

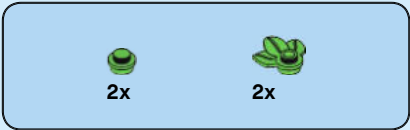

5

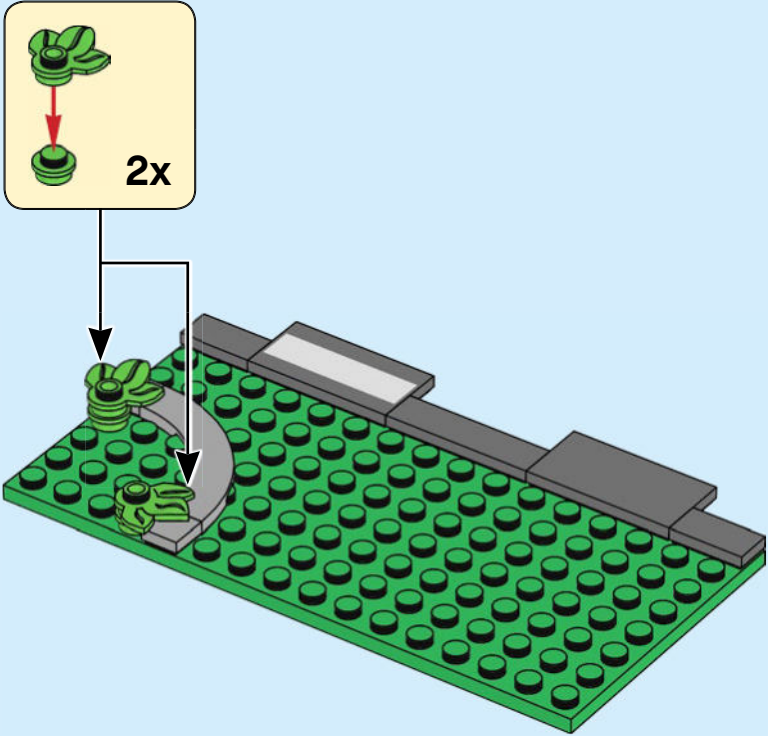

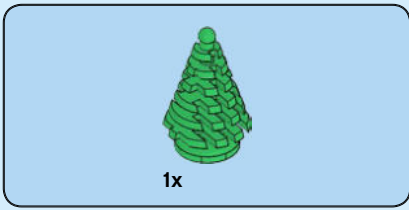

6

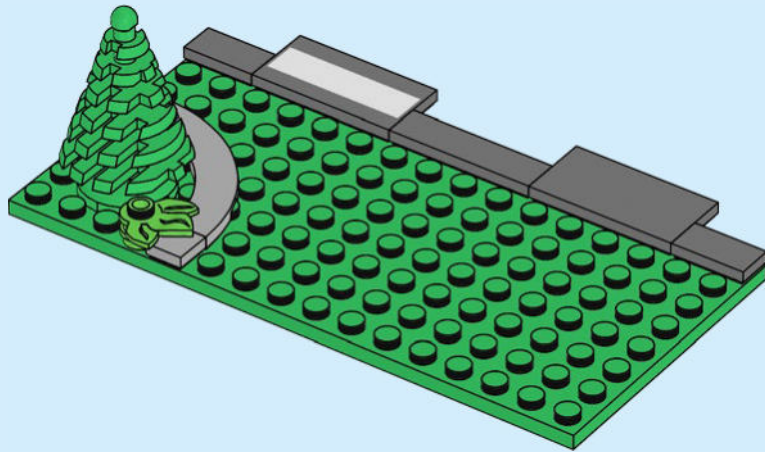



2x

7

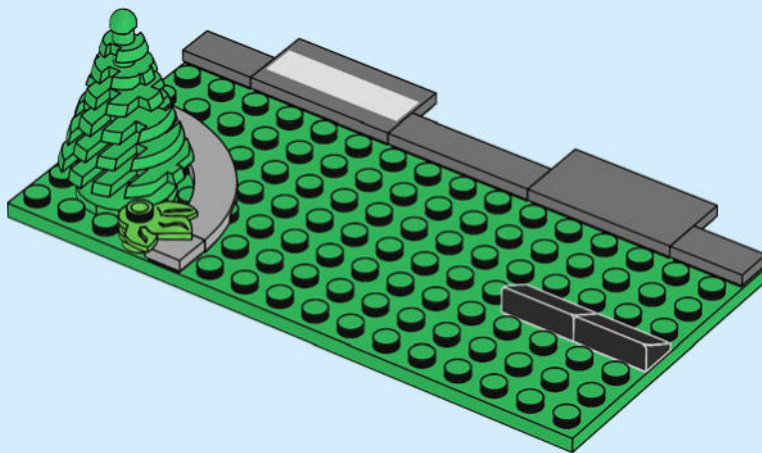

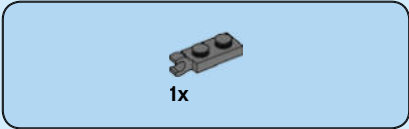

8

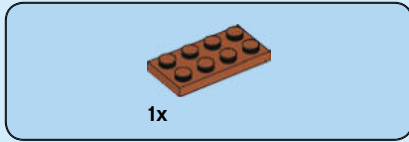

9

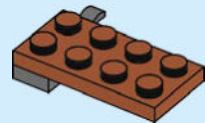



1x

10

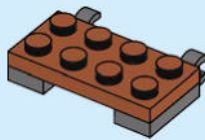





11

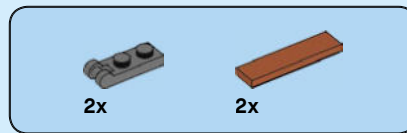
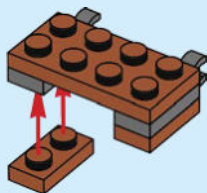

12

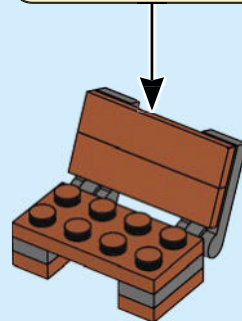
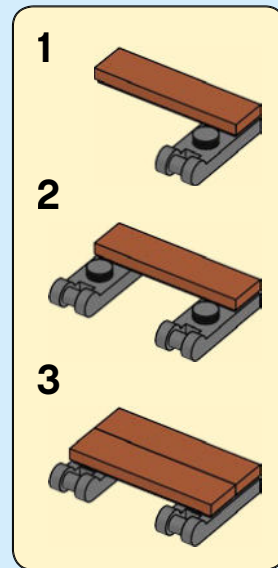

13

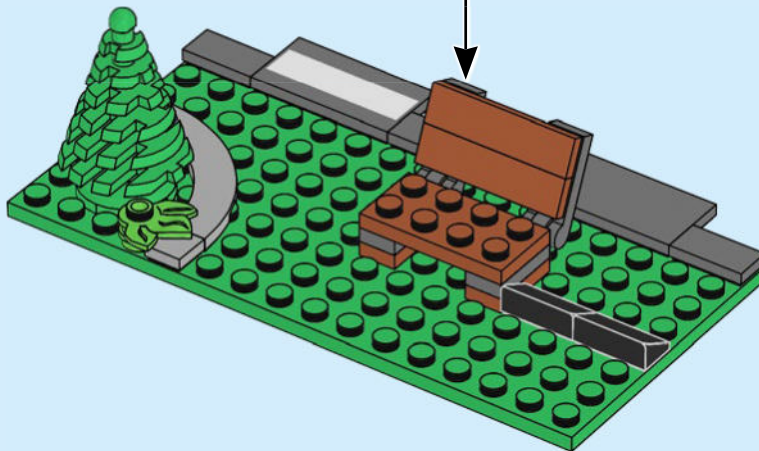

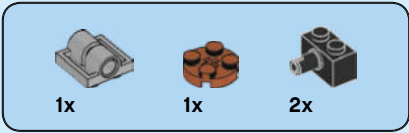

# 14

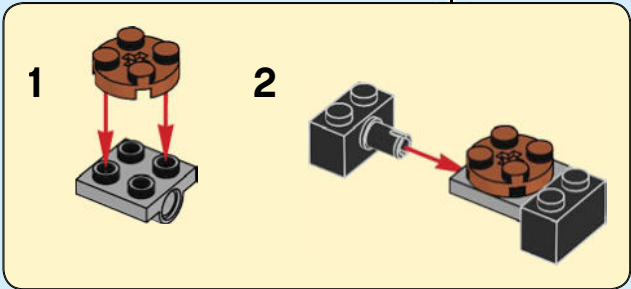
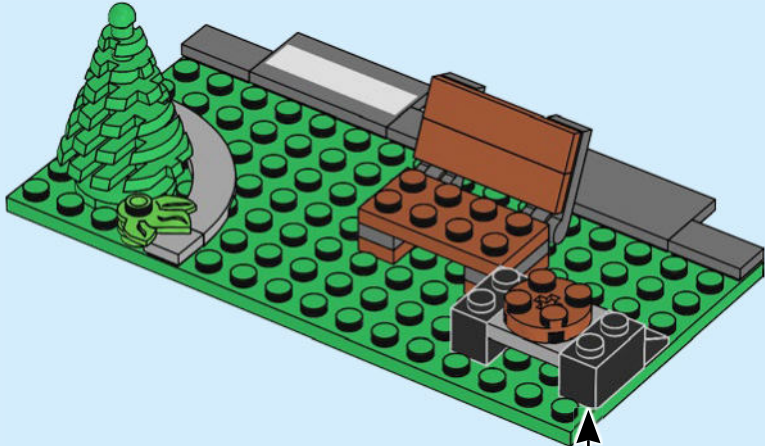



2x

15

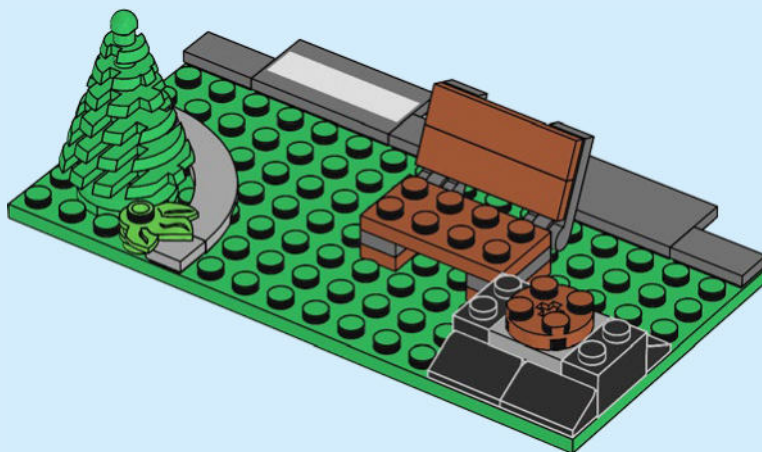

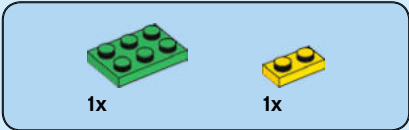

16

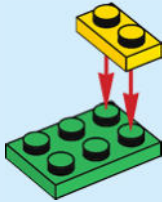

17





1x

18

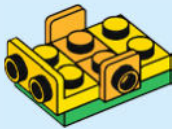

1x



1x

19

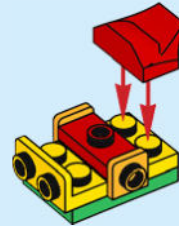



1x

20

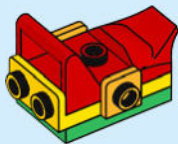

2x

21

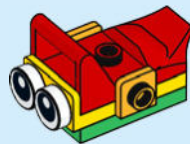



2x

22





23

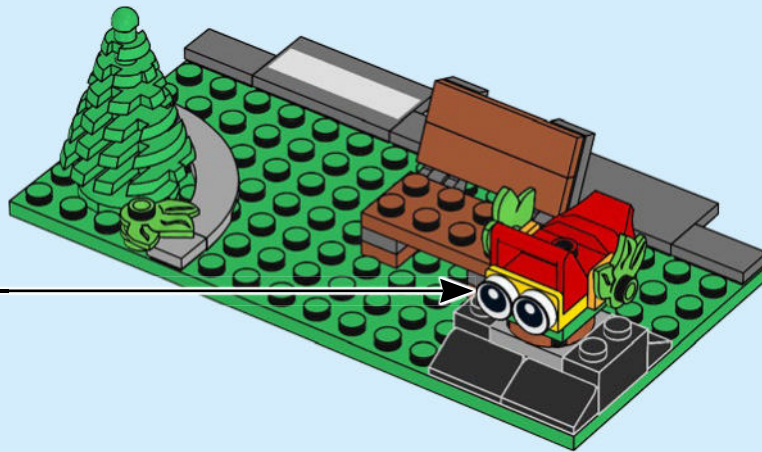

24

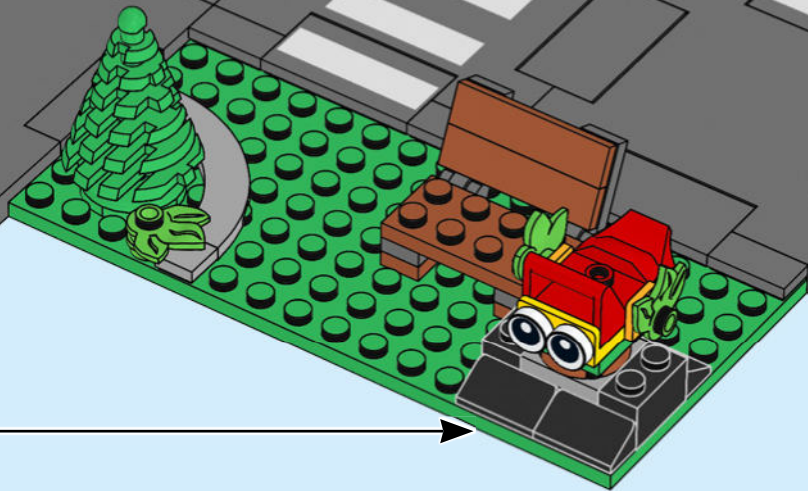

# CITY

## ADVENTURES

City Abenteuer  
 Aventuras en City  
 City Aventuras  
 City kalandok  
 City piedzīvojumi  
 乐高城市大冒险



60242



60243



60243 • 60276



60244



60244 • 60277



60245



60245



60246



60246



60276



60277



60242  
60246  
60276



60248 • 60280



60247 • 60281



60282



60282



60258



60258 • 60266



60292



60292



# CITY

## ADVENTURES

City Abenteuer  
Aventuras en City  
City Aventuras  
City kalandok  
City piedzīvojumi  
乐高城市大冒险

Aus der erfolgreichen TV-Serie!  
Vu dans la série télévisée à succès !  
Dalla divertentissima serie TV!  
¡De la popular serie de la tele!  
Da série de sucesso da TV!  
A népszerű TV-sorozatból!  
No populārā TV seriāla!  
源自热门动画片!



FROM THE HIT  
TV SERIES!



# CITY

60292



5



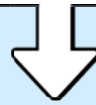
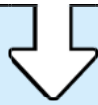
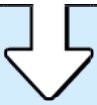

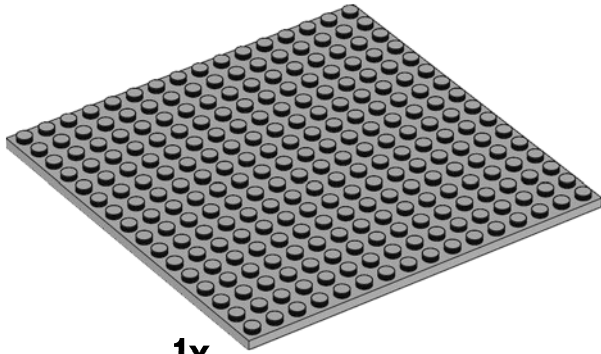

1x

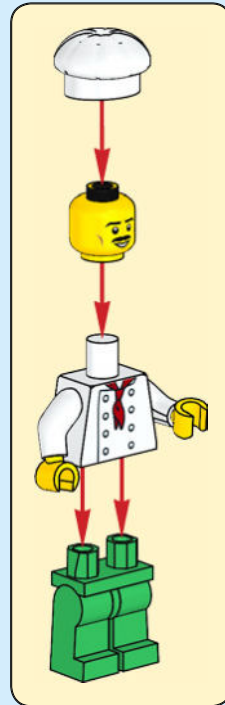
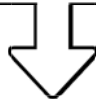



1

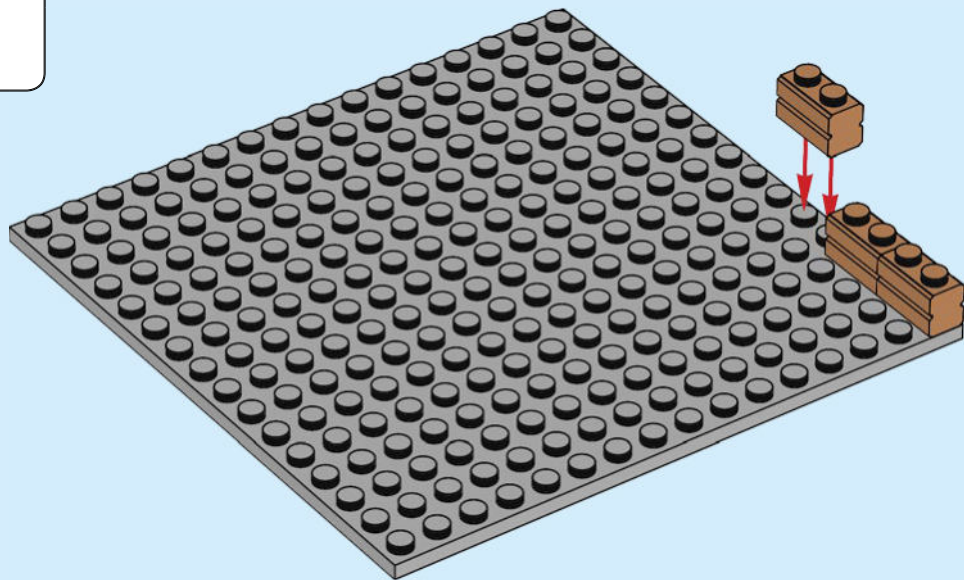



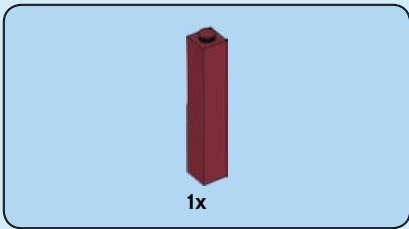

2

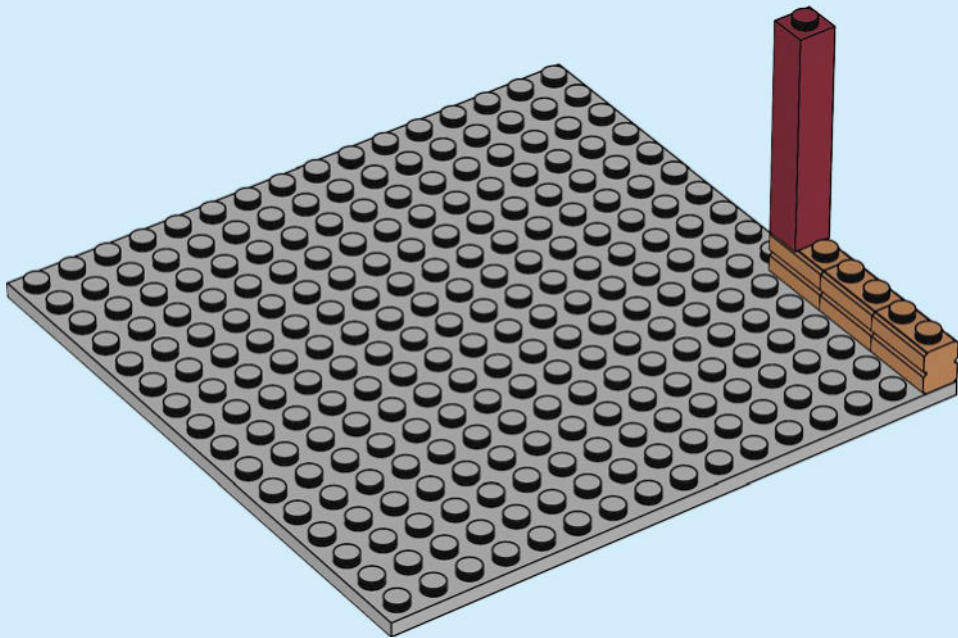

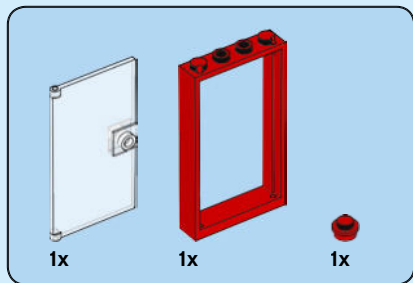

3

1

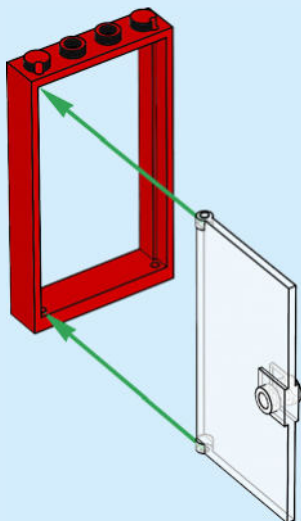

2

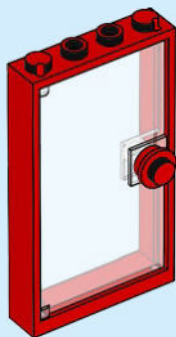

3

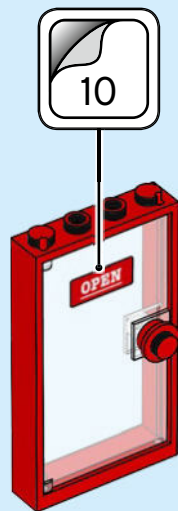

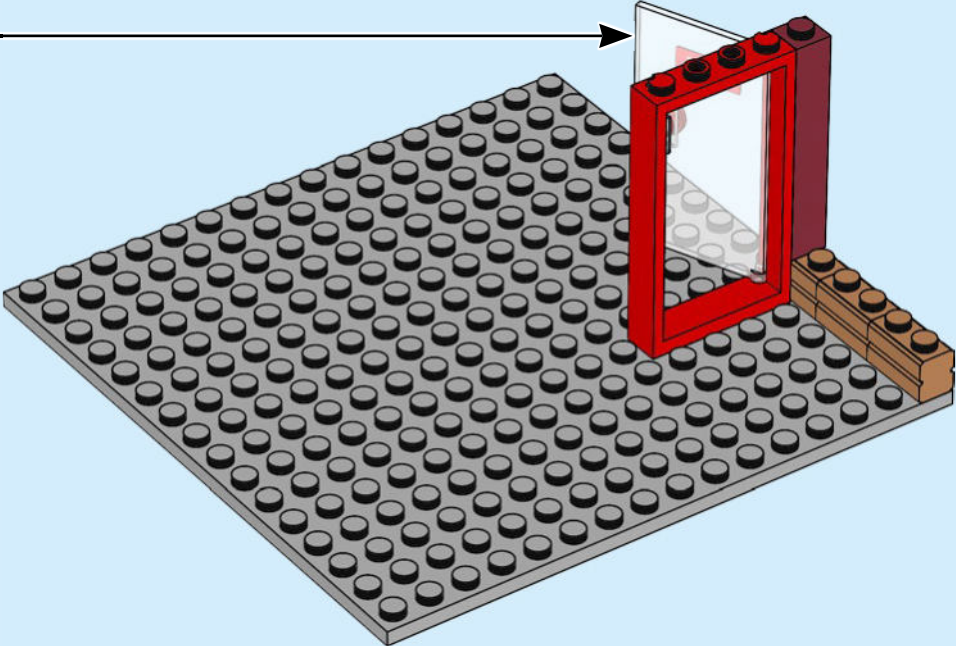



1x



3x

4

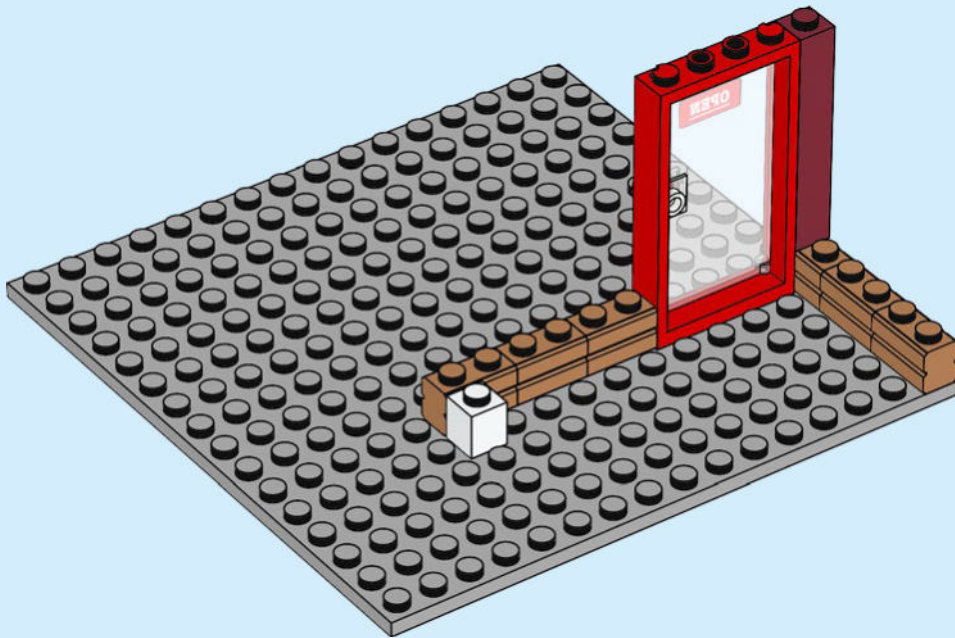



3x

5

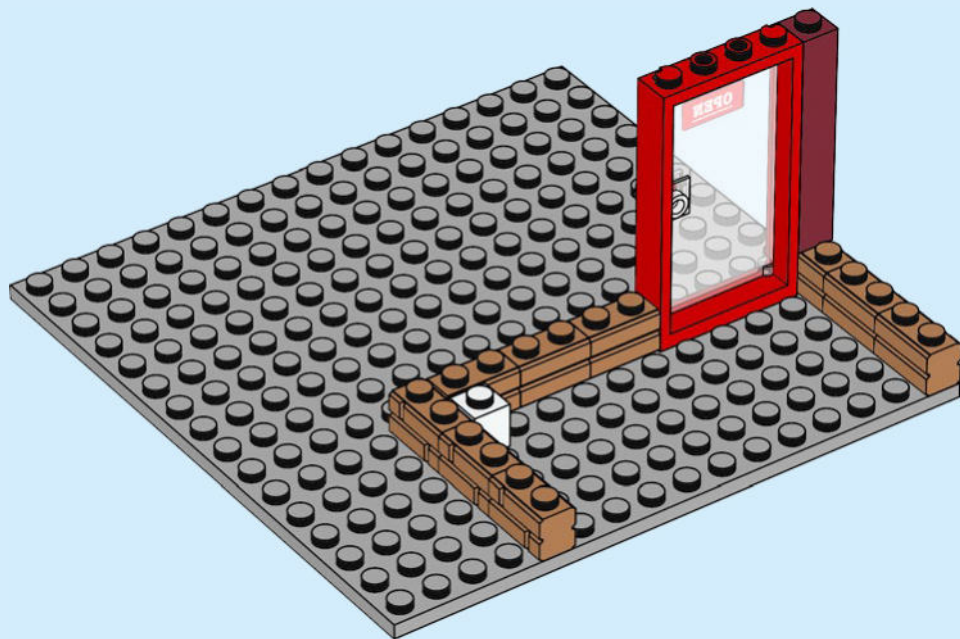



1x



1x

6

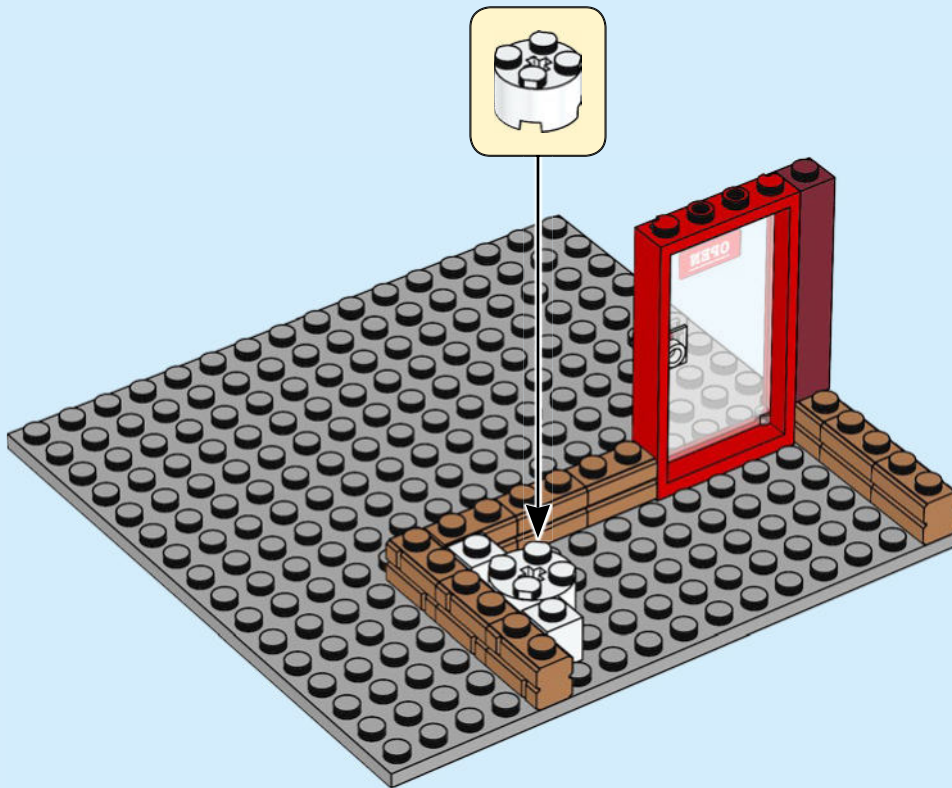



2x

7

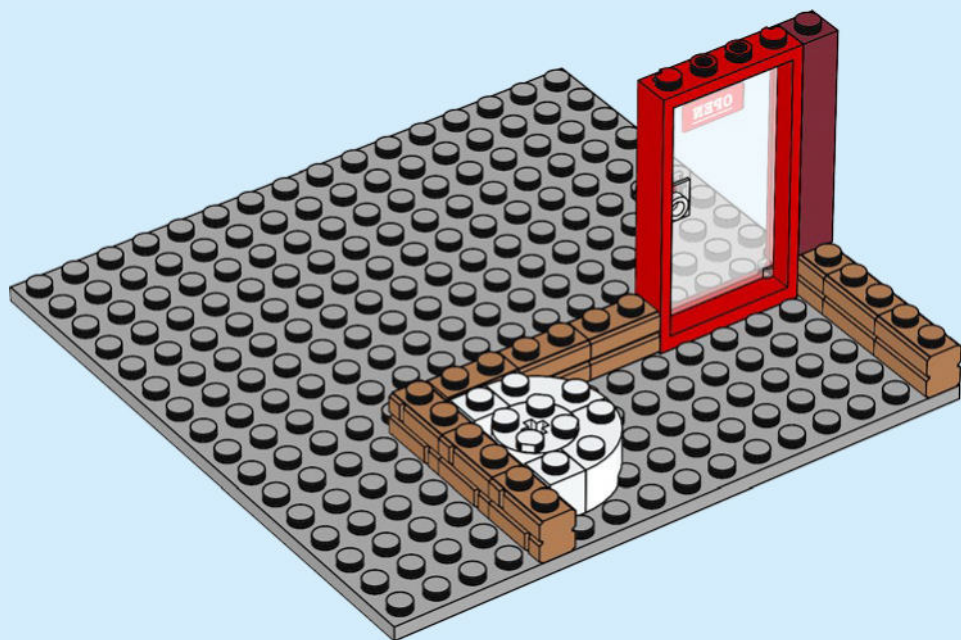





2x



1x

8

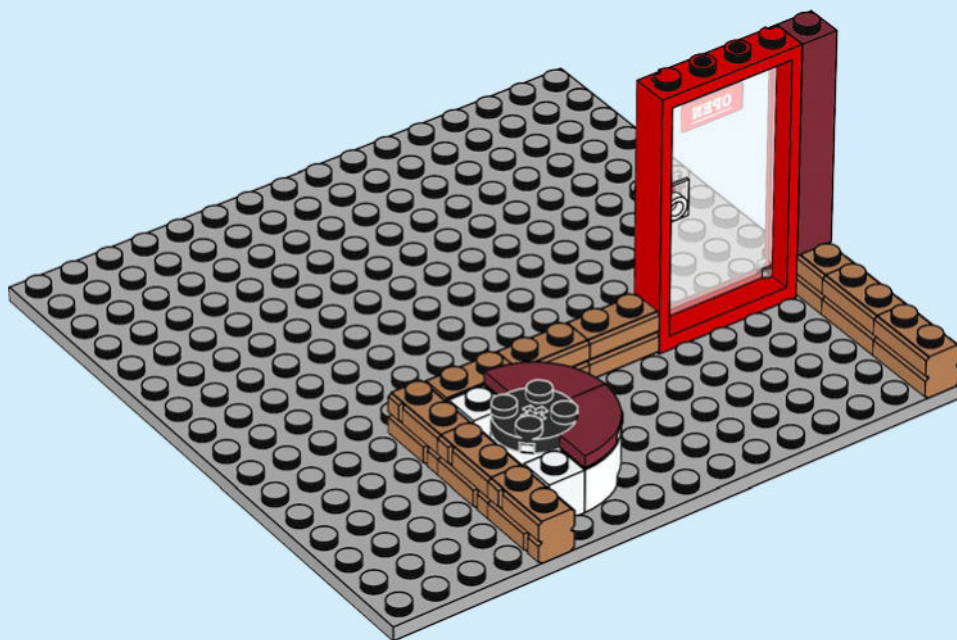





1x



1x

9

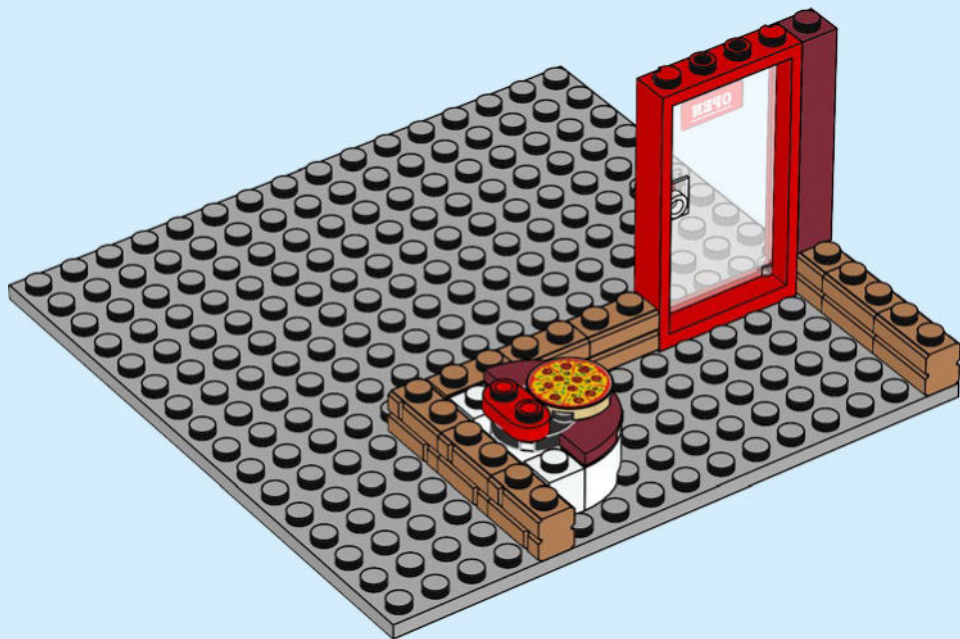



2x



2x

# 10

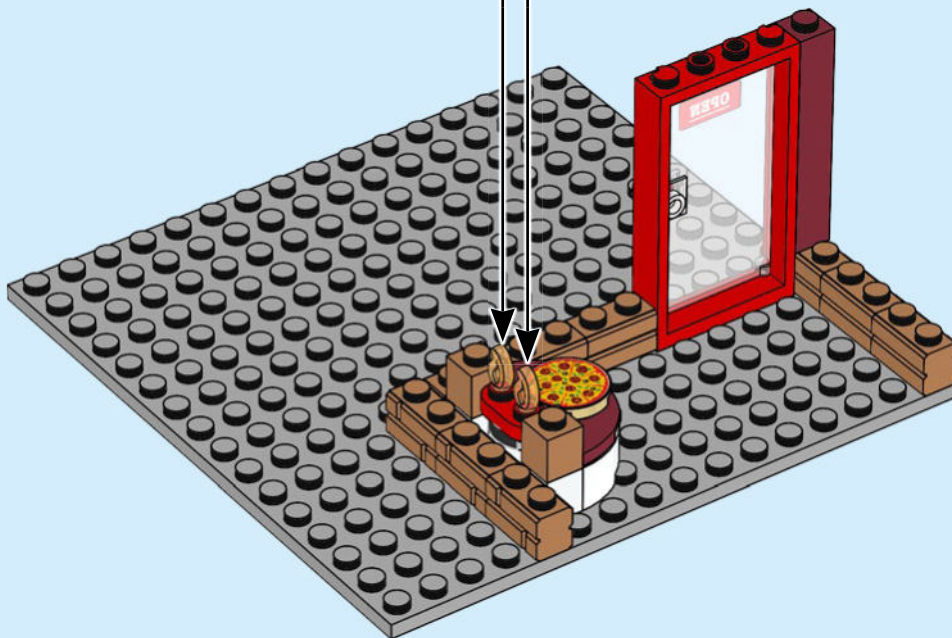

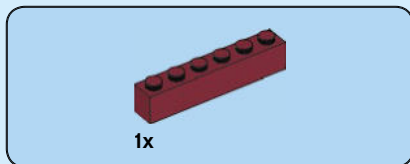

11



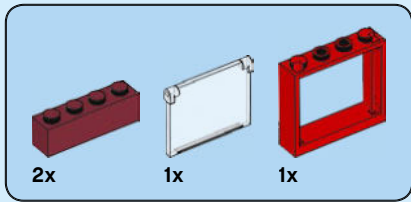

# 12

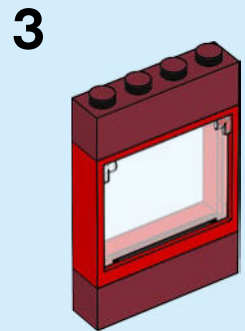
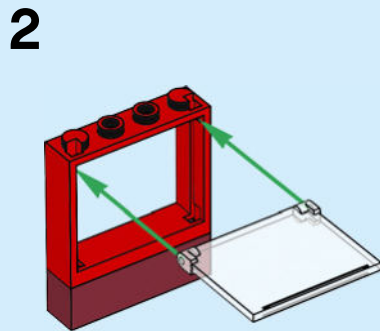
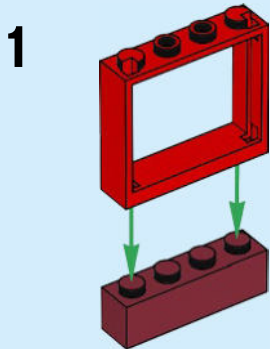



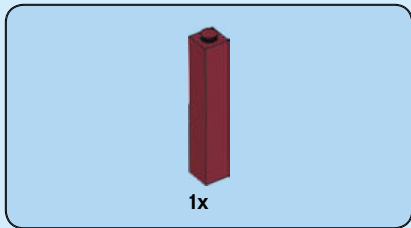

13





3x

14





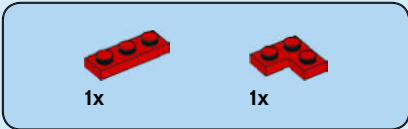

15







1x

16



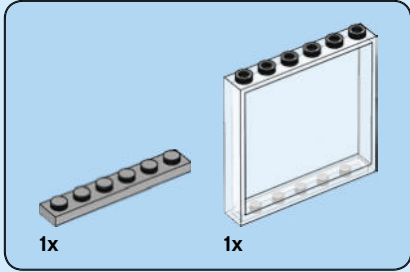

17

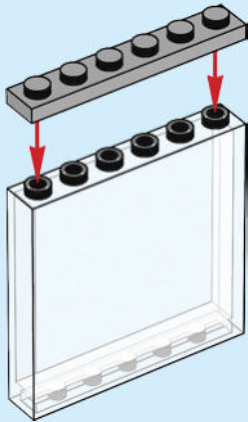

18

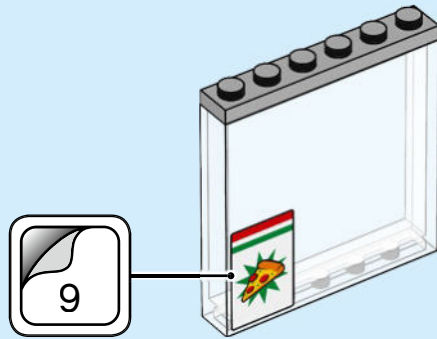

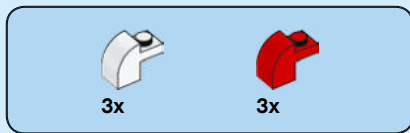

19

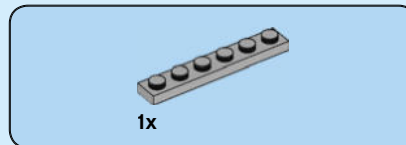
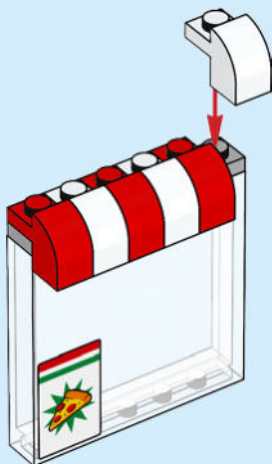

20

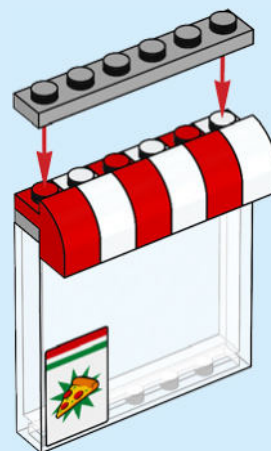

21

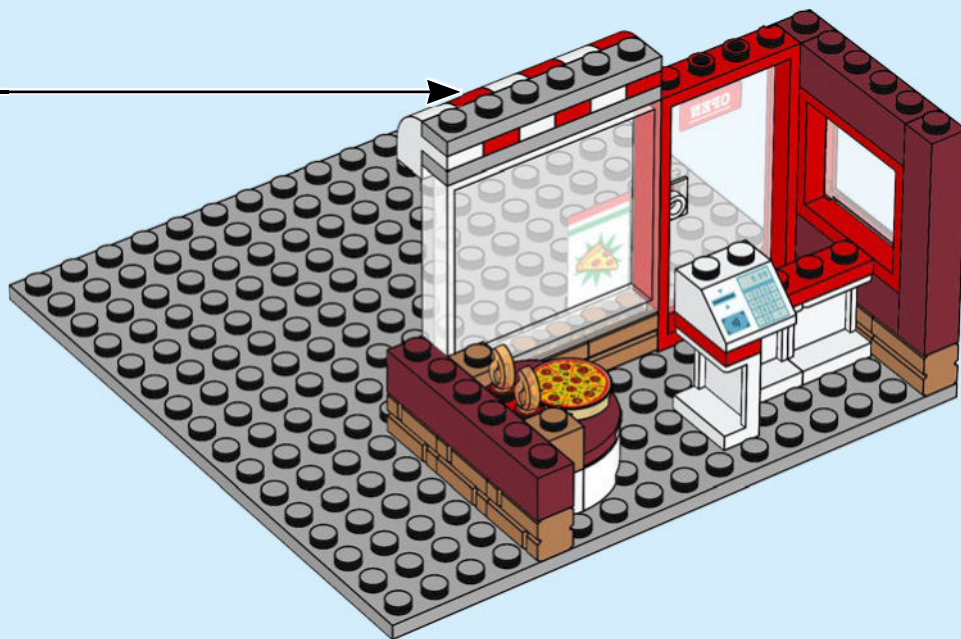

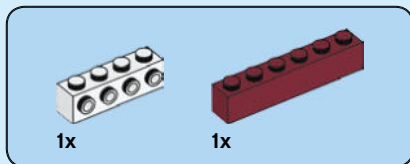

22





1x

23

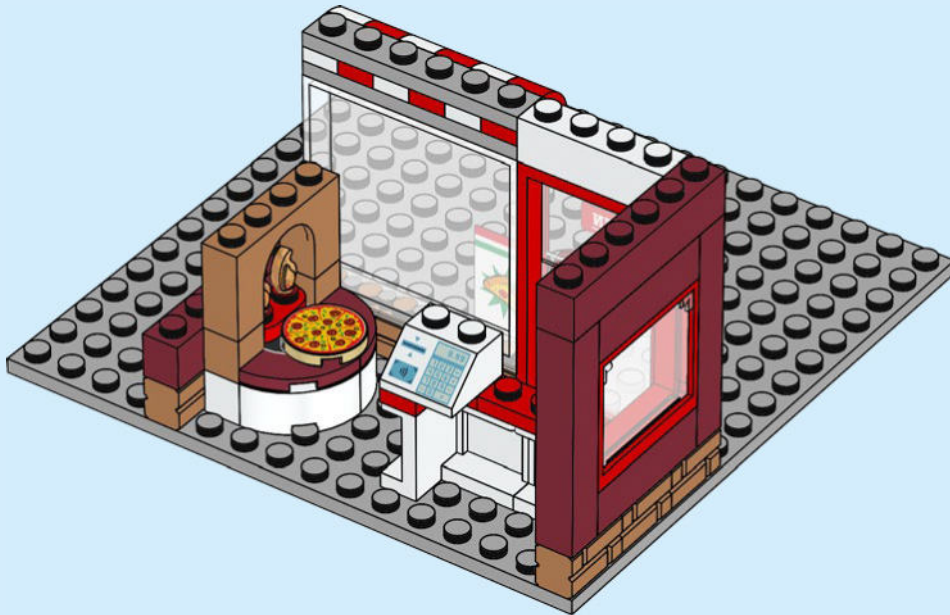



2x

24

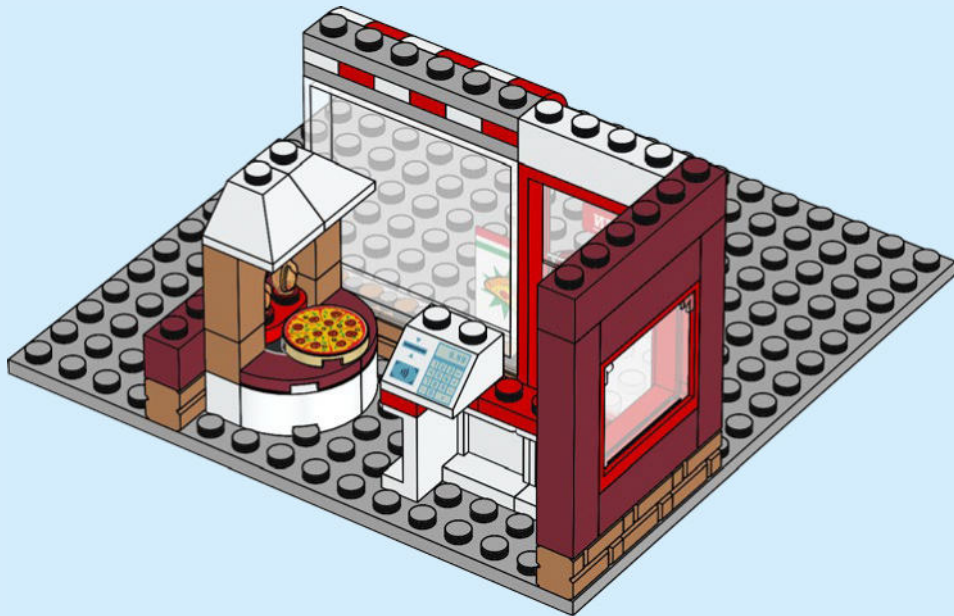



2x

25

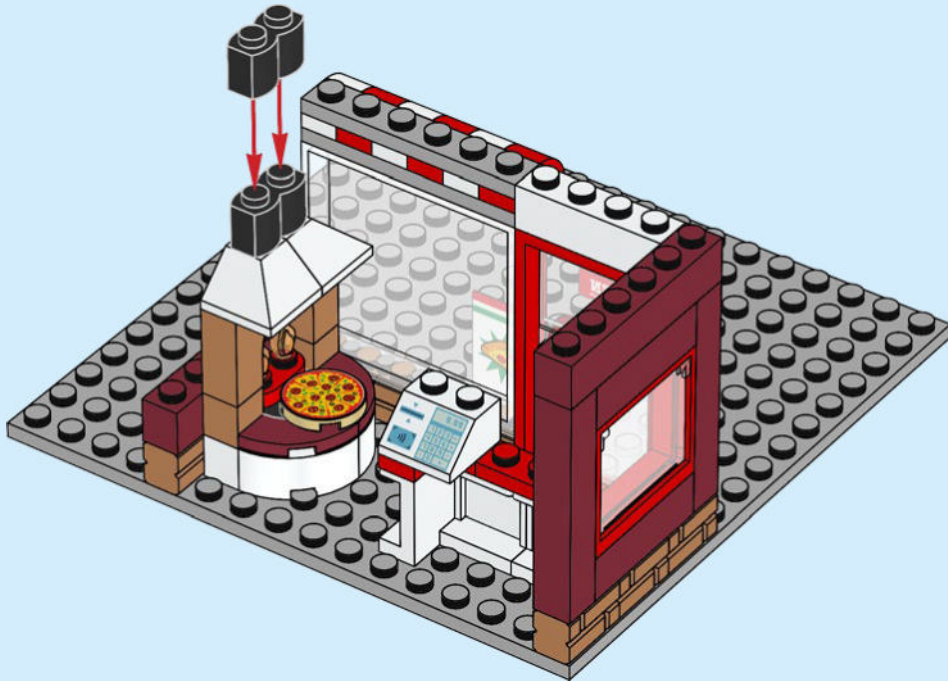



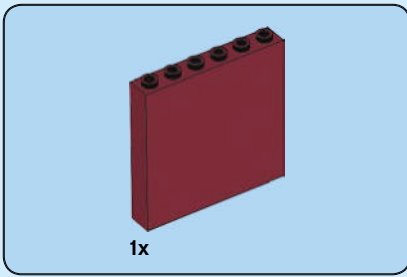

26





2x



1x

27



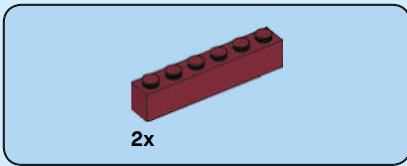

28





1x

29

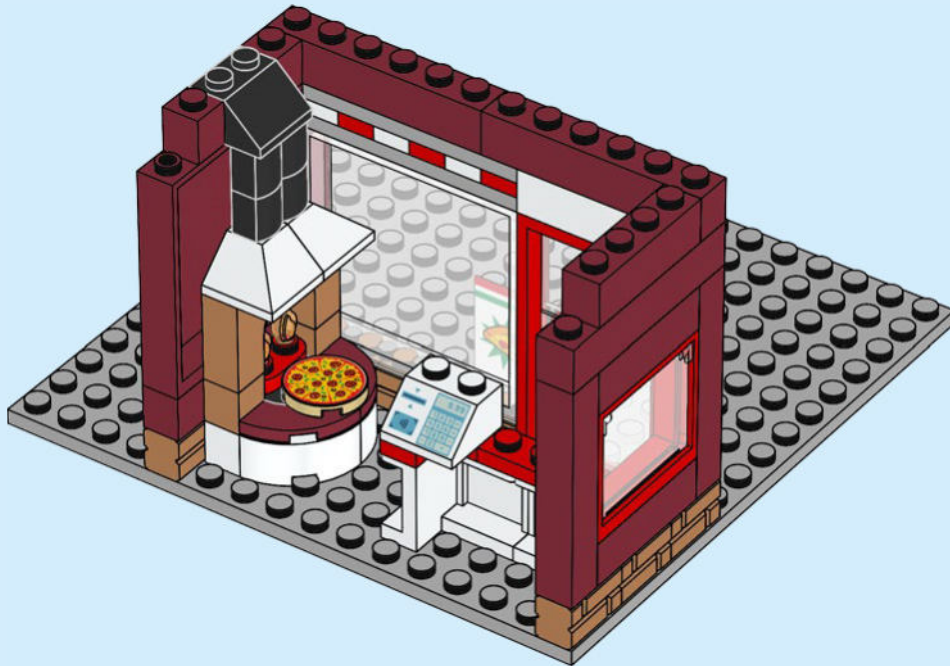

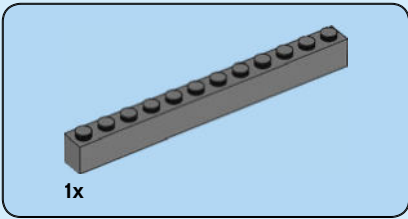

30

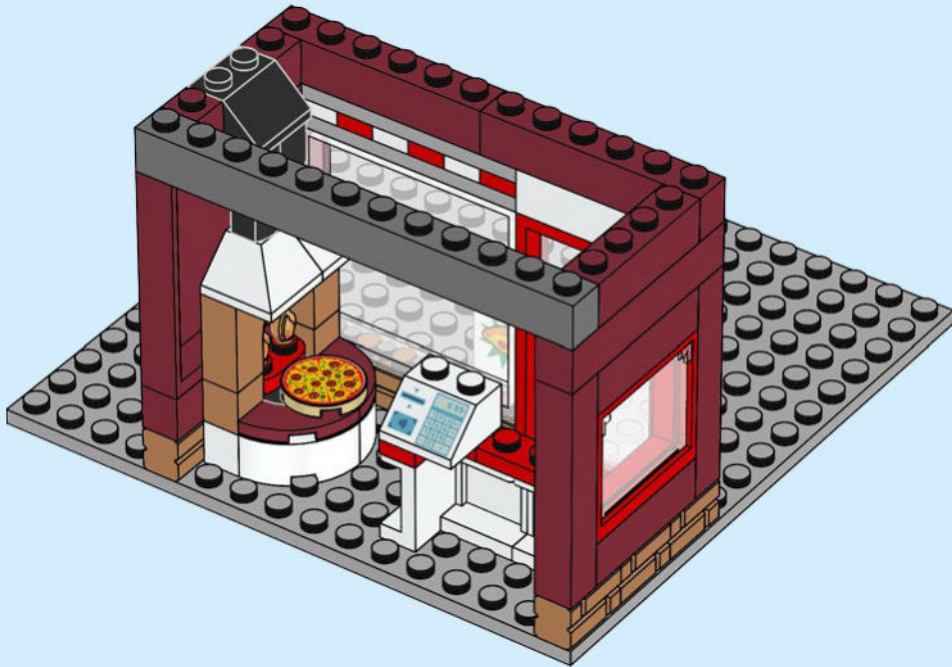

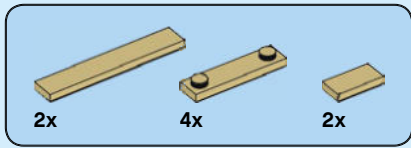

31

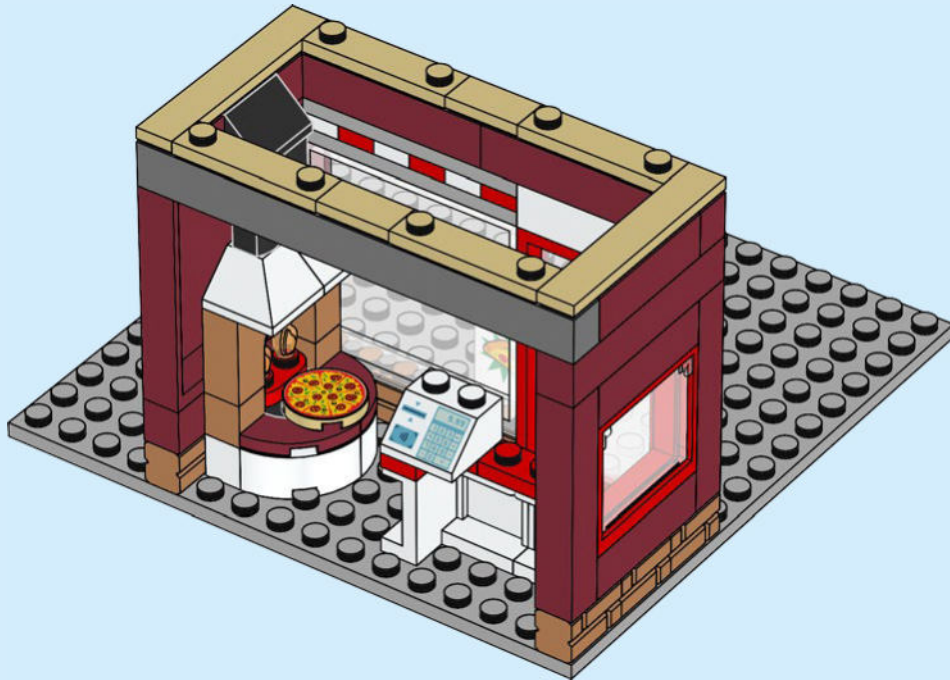



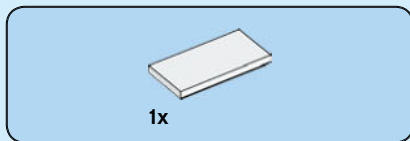

32

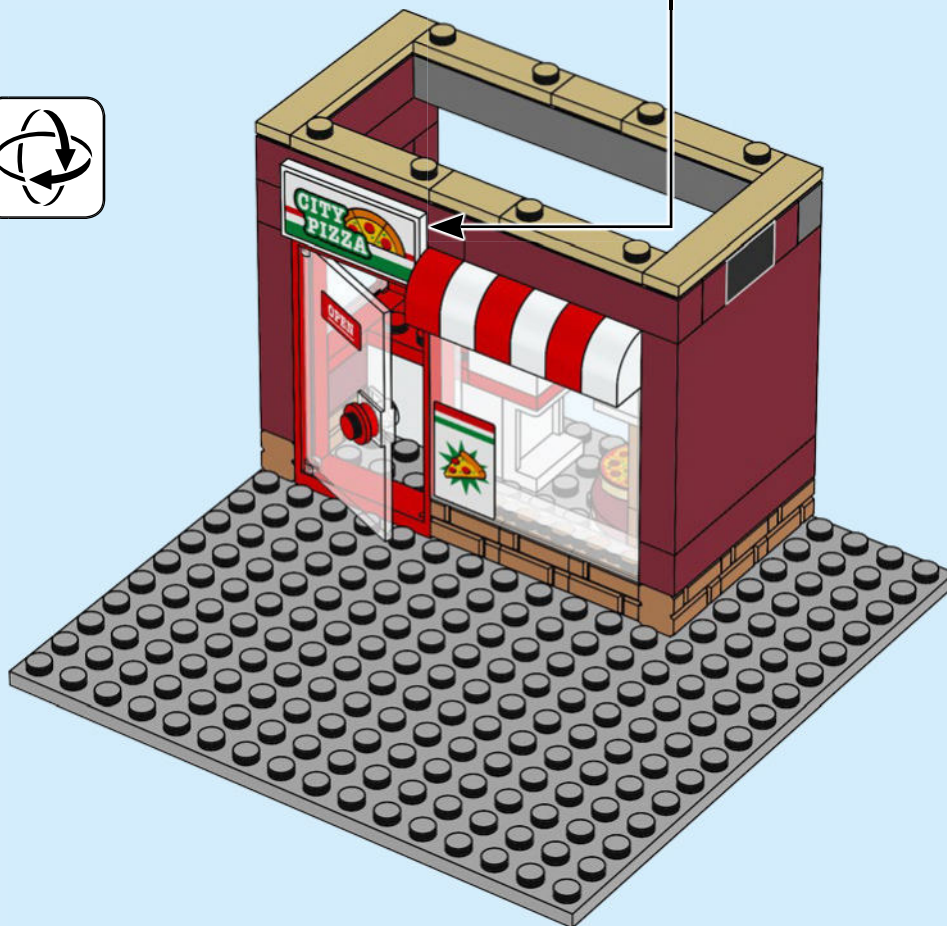
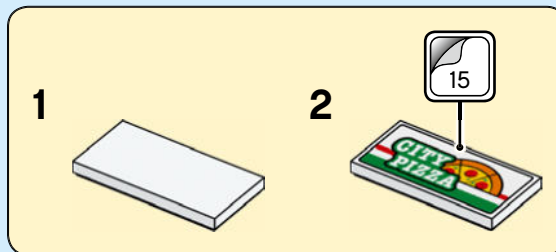

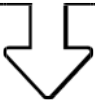



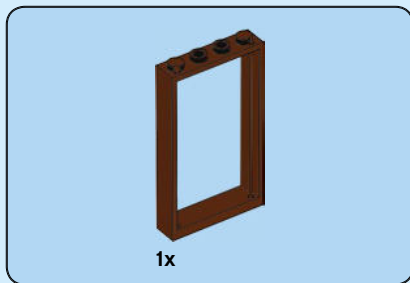

33



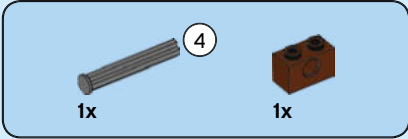
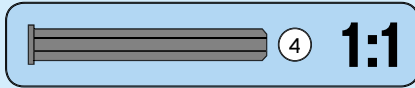

34

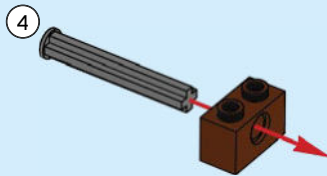

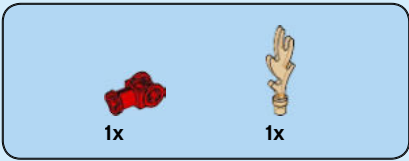

35

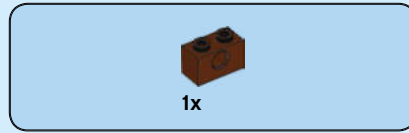
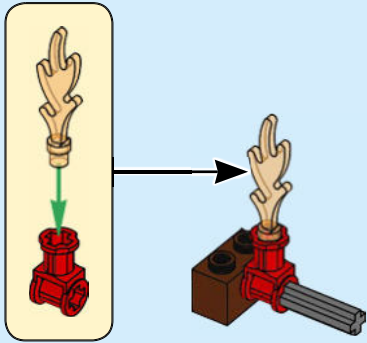

36

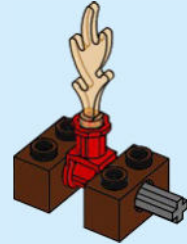



1x

37

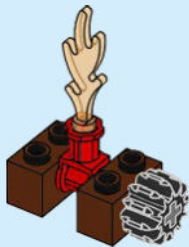

1x

38

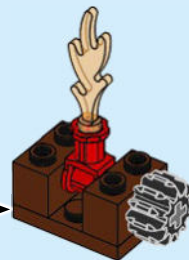

39

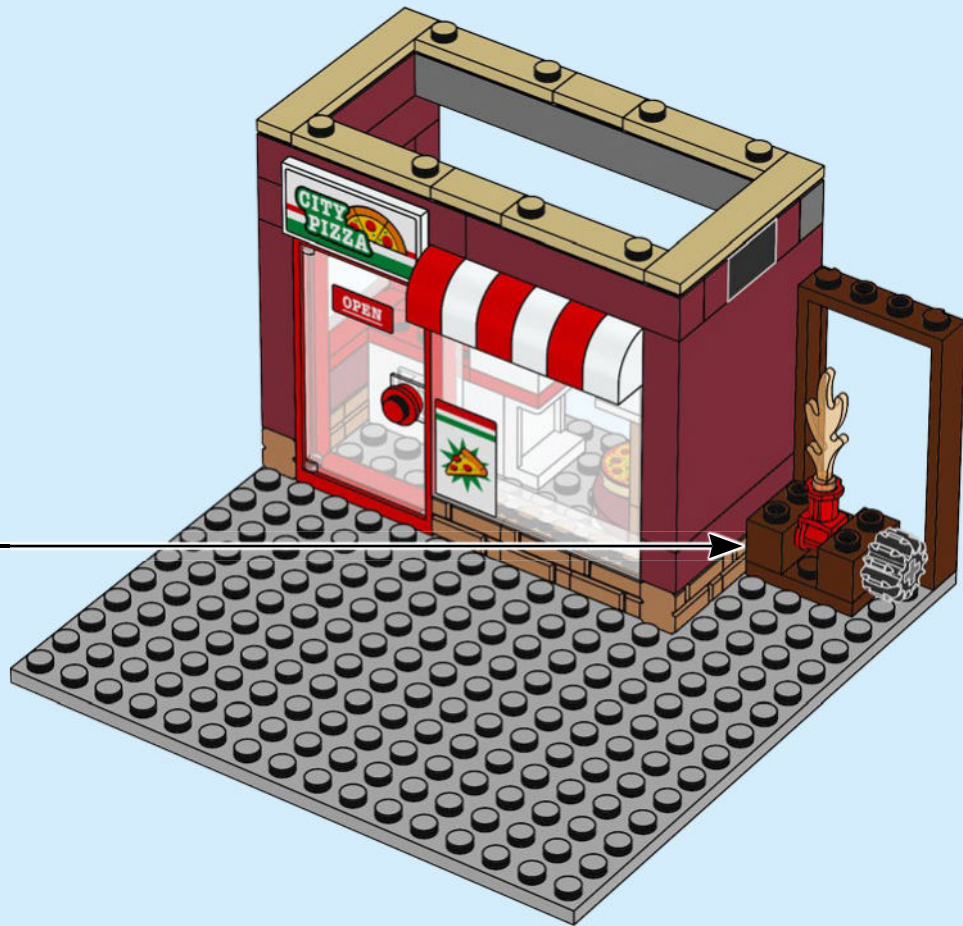

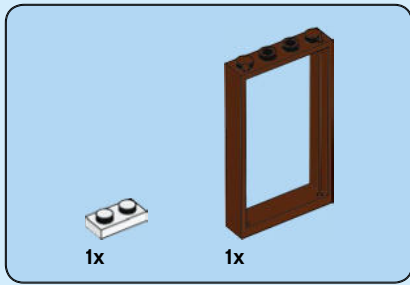

40





2x

41

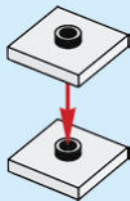

1x

42

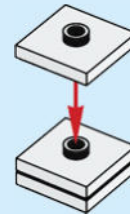

1x

43

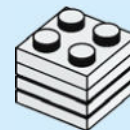



1x



1x

44

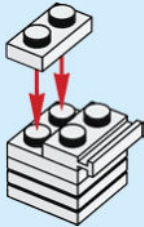

1x

45





46

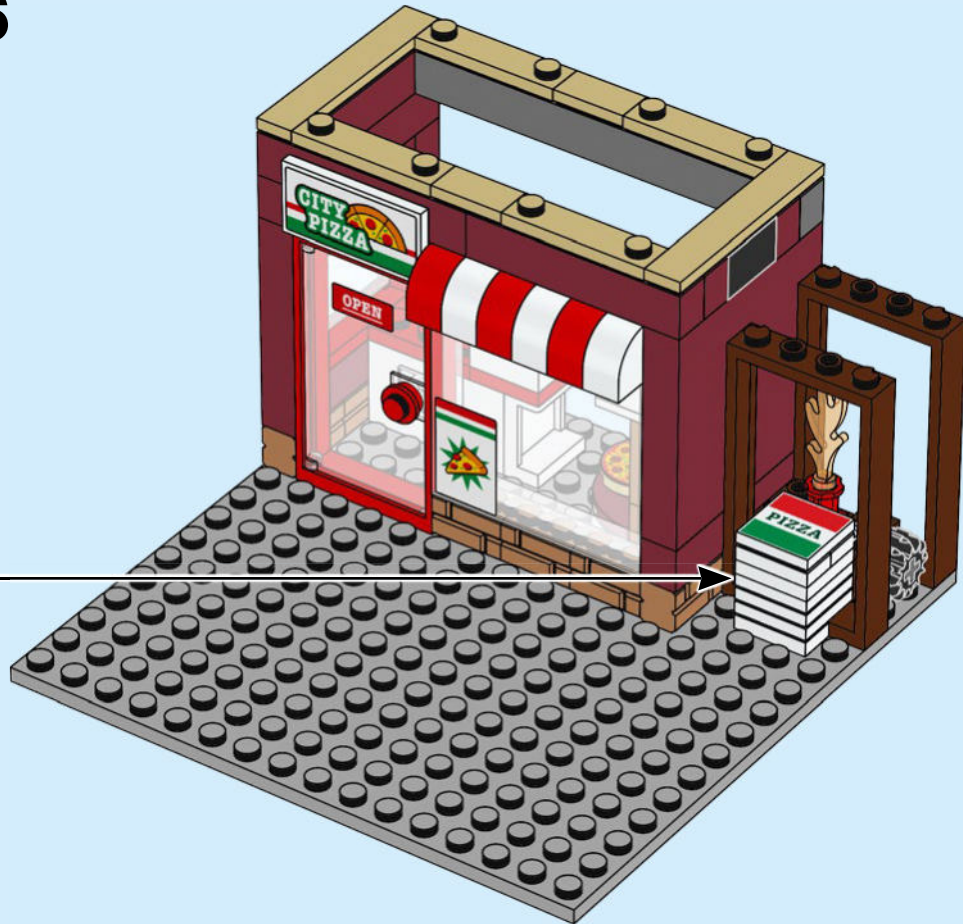



2x

47



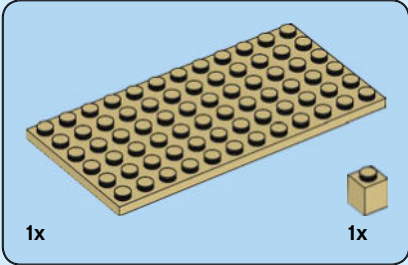
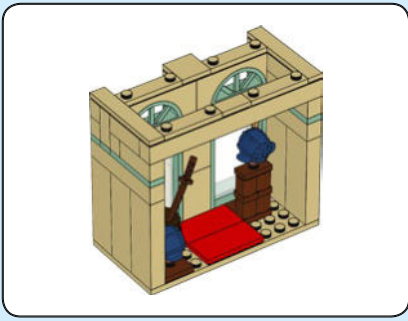

48

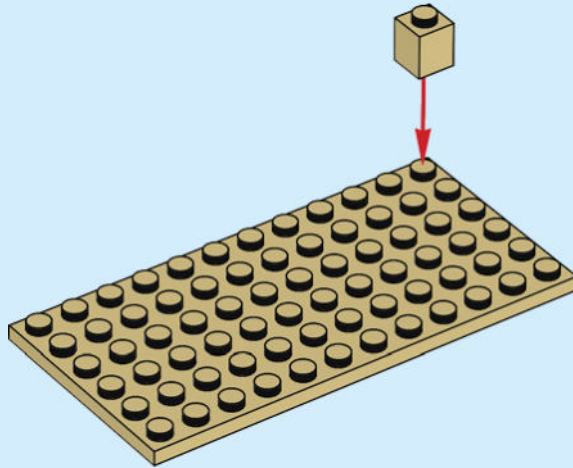

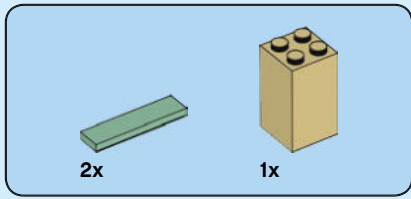

49

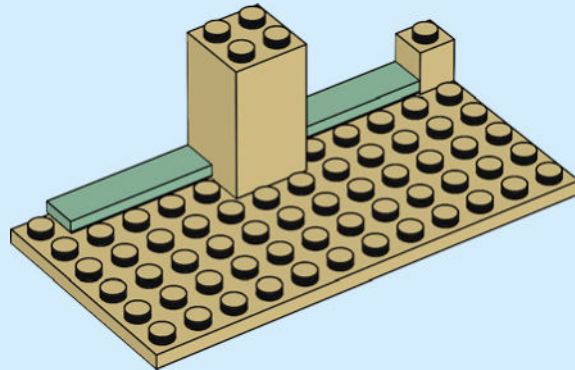

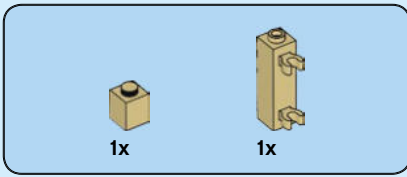

50

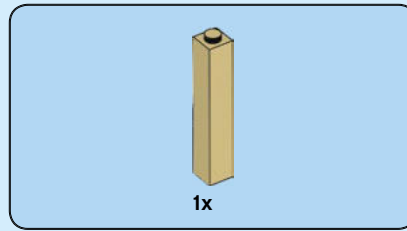
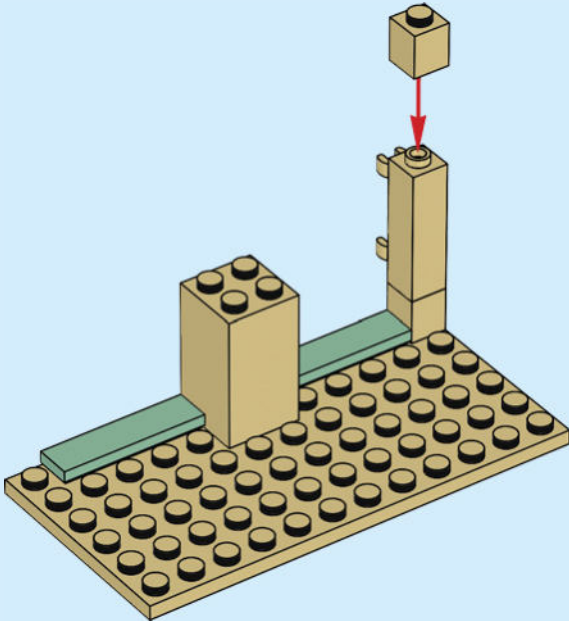

51

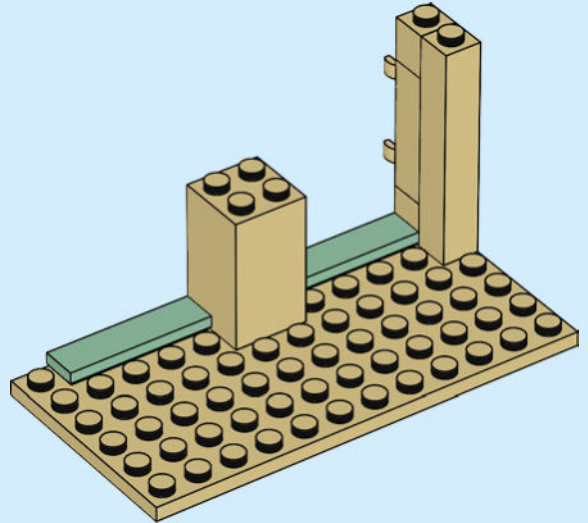

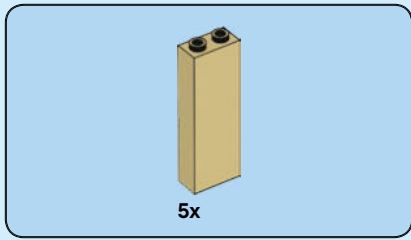

52

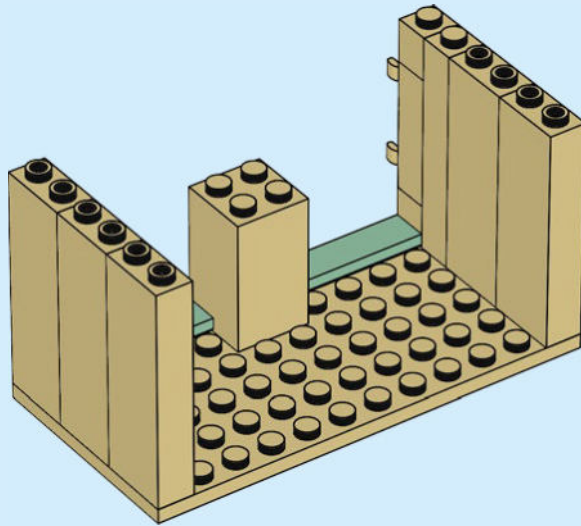

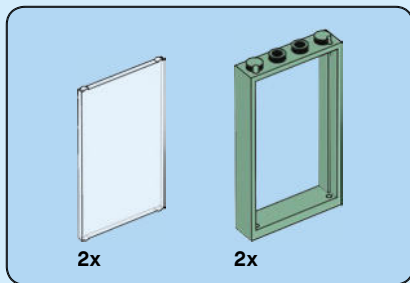

**53**

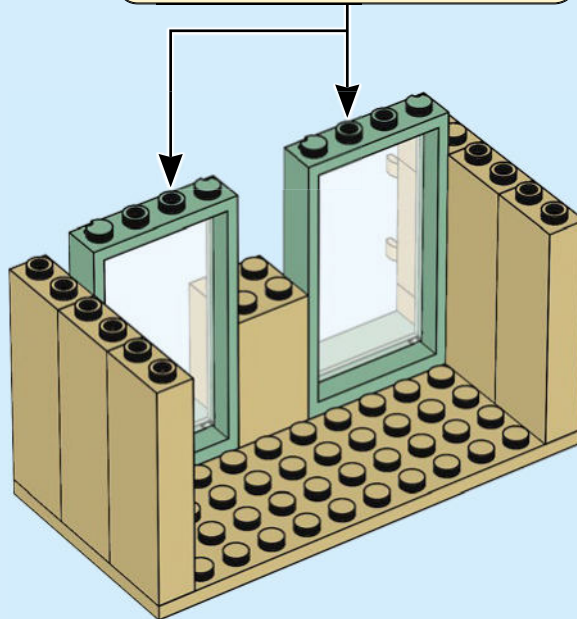
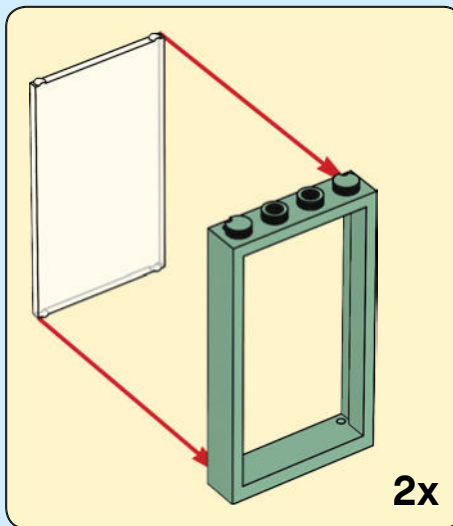



1x

54

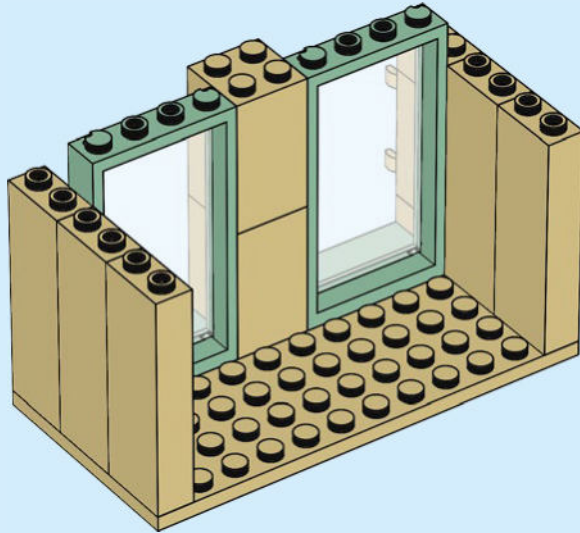





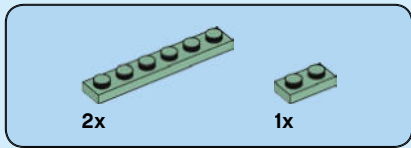

56

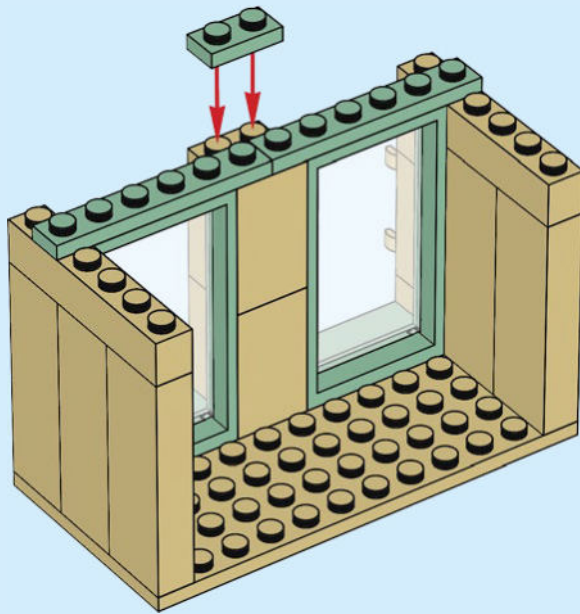



57

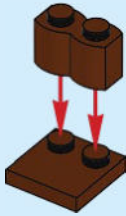

58

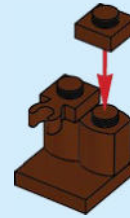

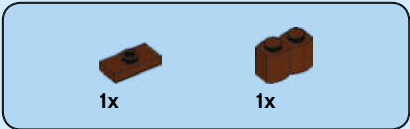

59

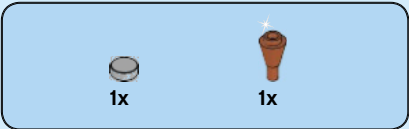
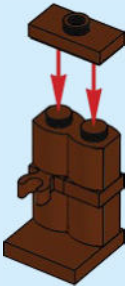

60





61



62

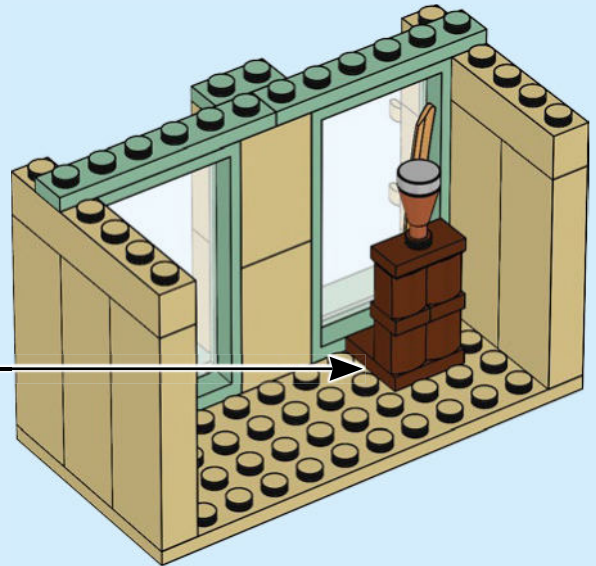

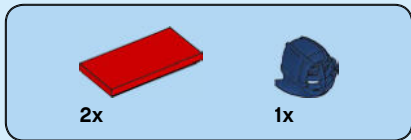

63

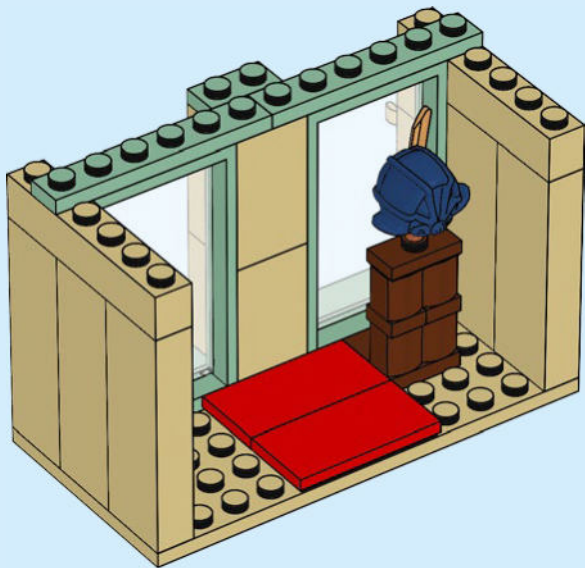

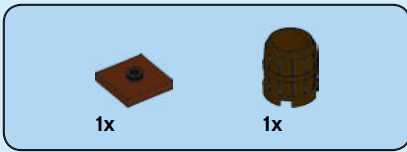

64

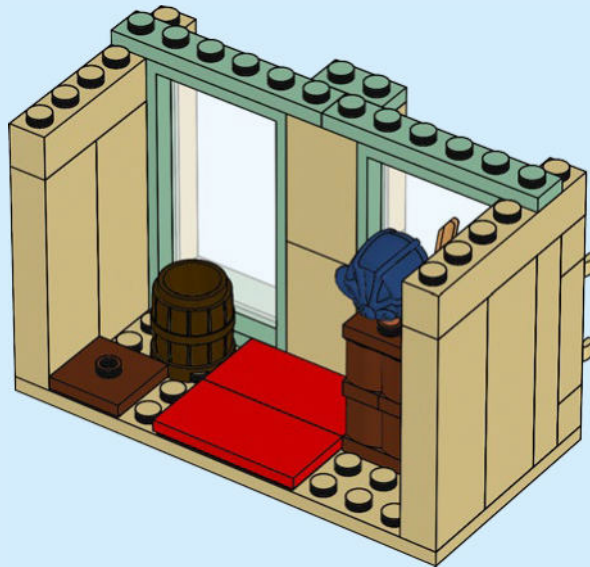

1x



1x

65

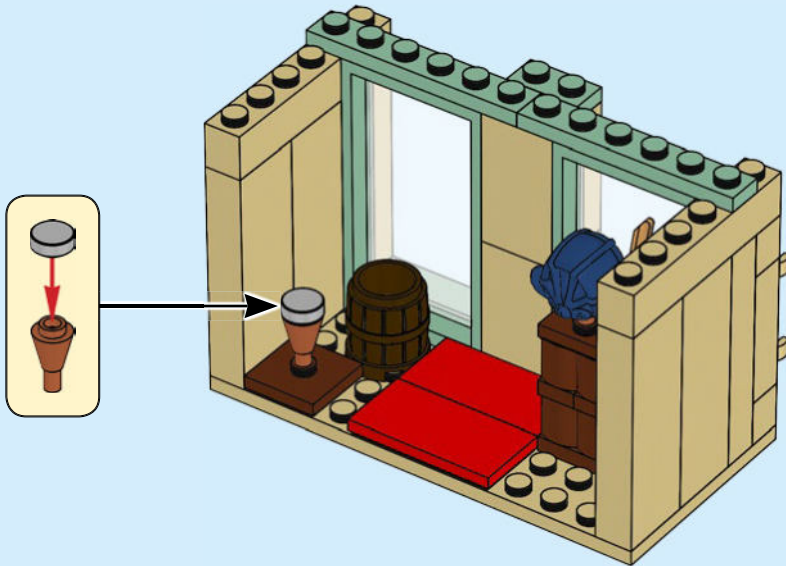



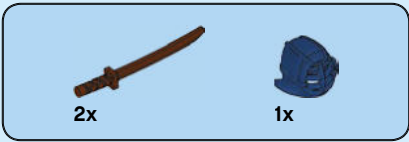

66

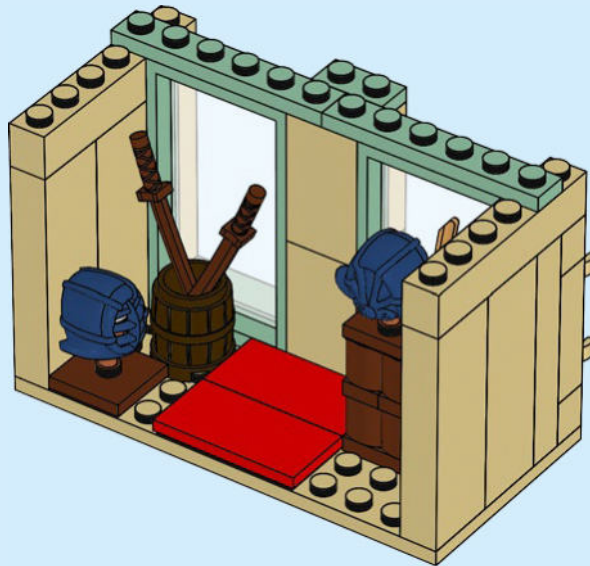



2x

67

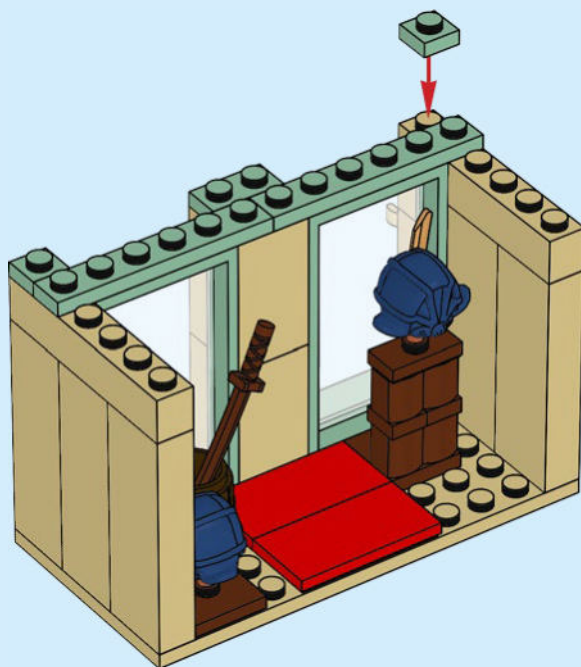

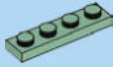

2x

68

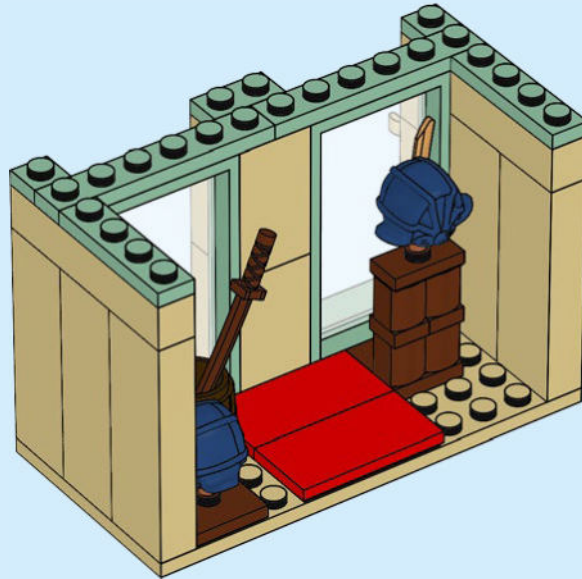

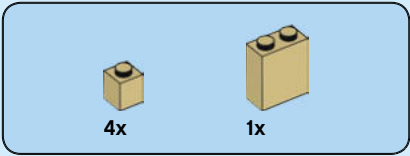

69

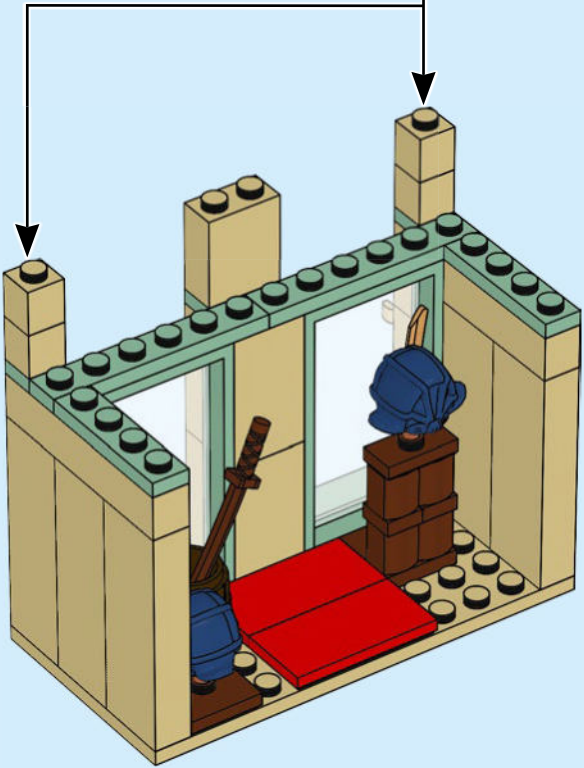
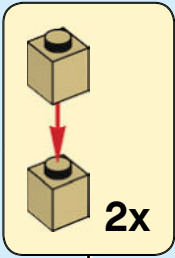



2x

70

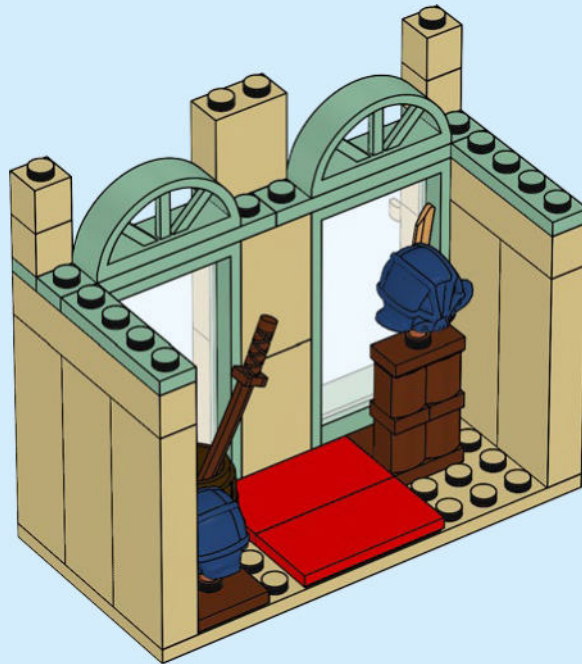

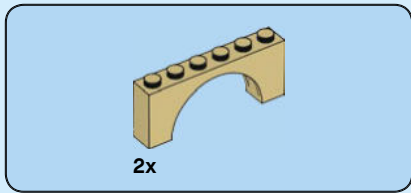

71

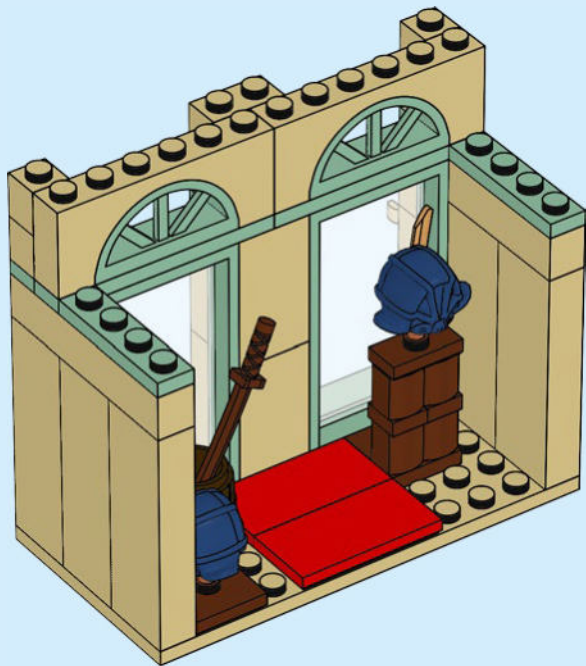



2x



2x

72

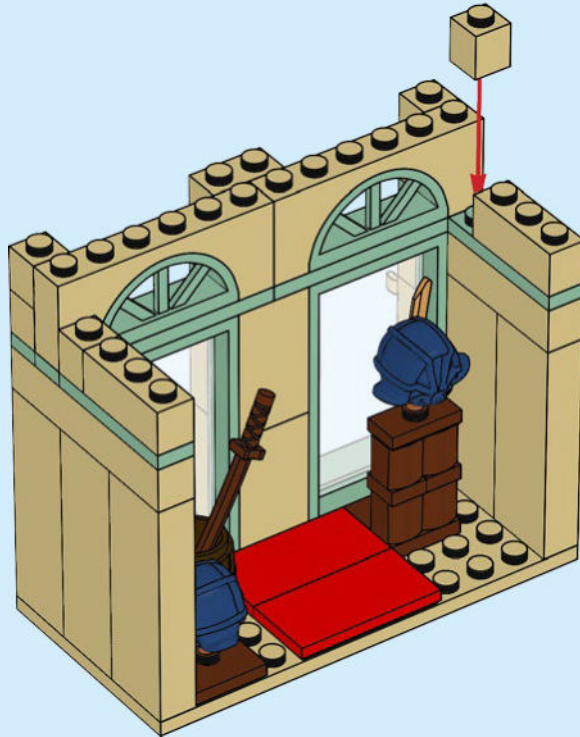



2x

73





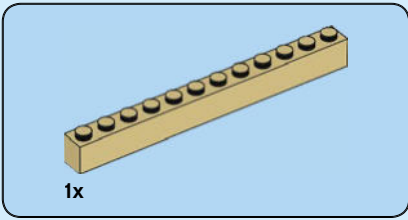

74



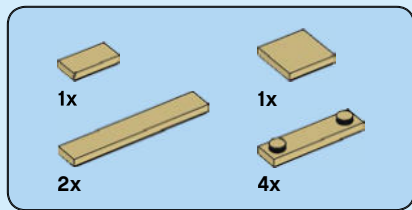

75

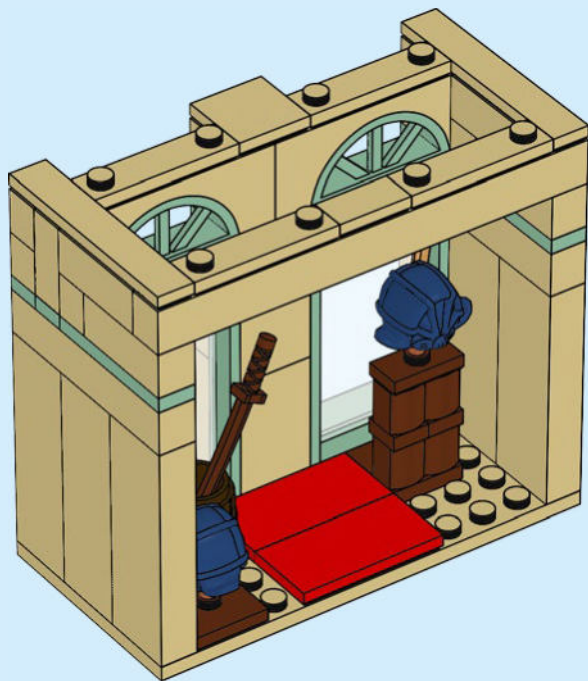

76

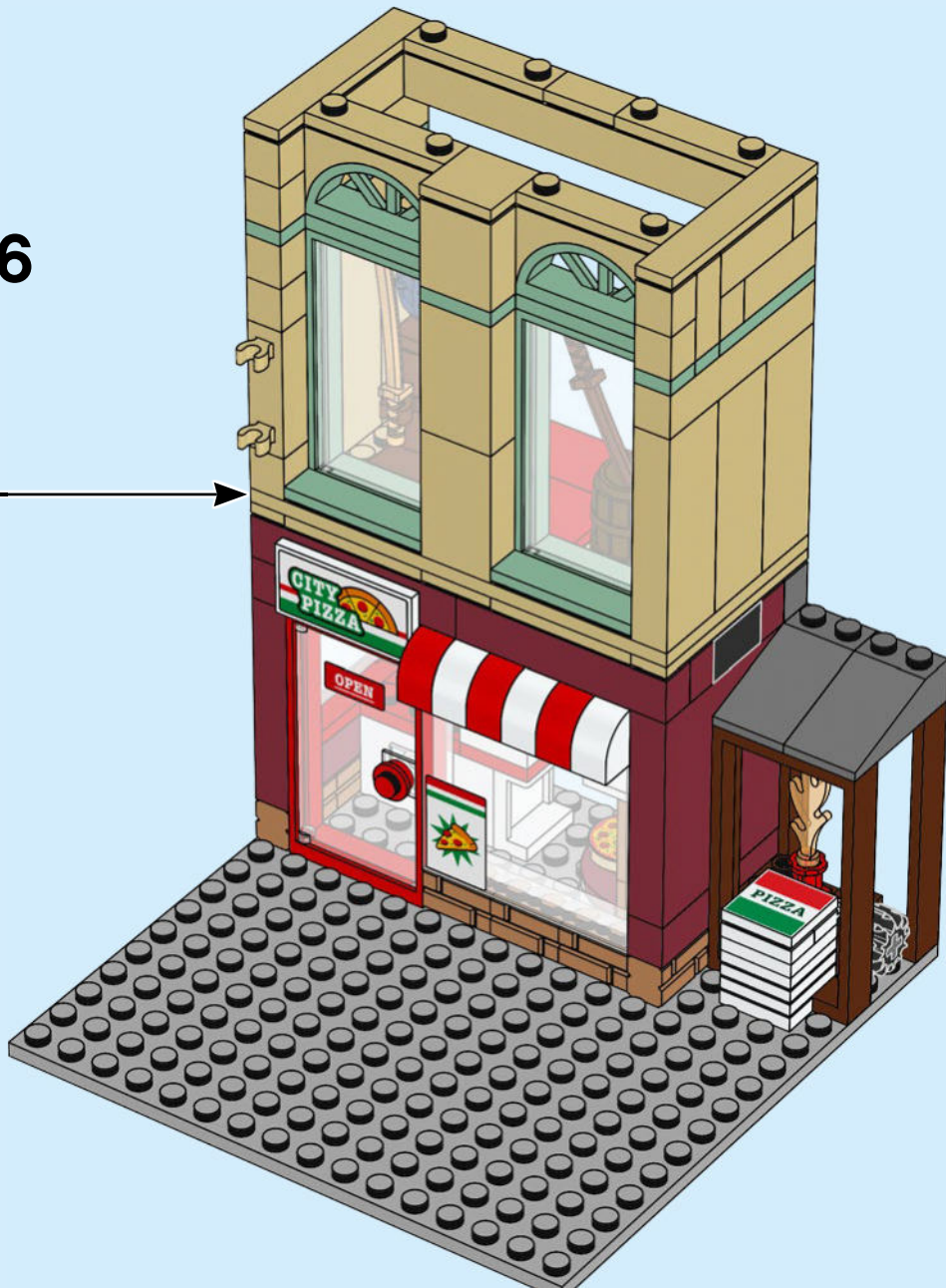



77

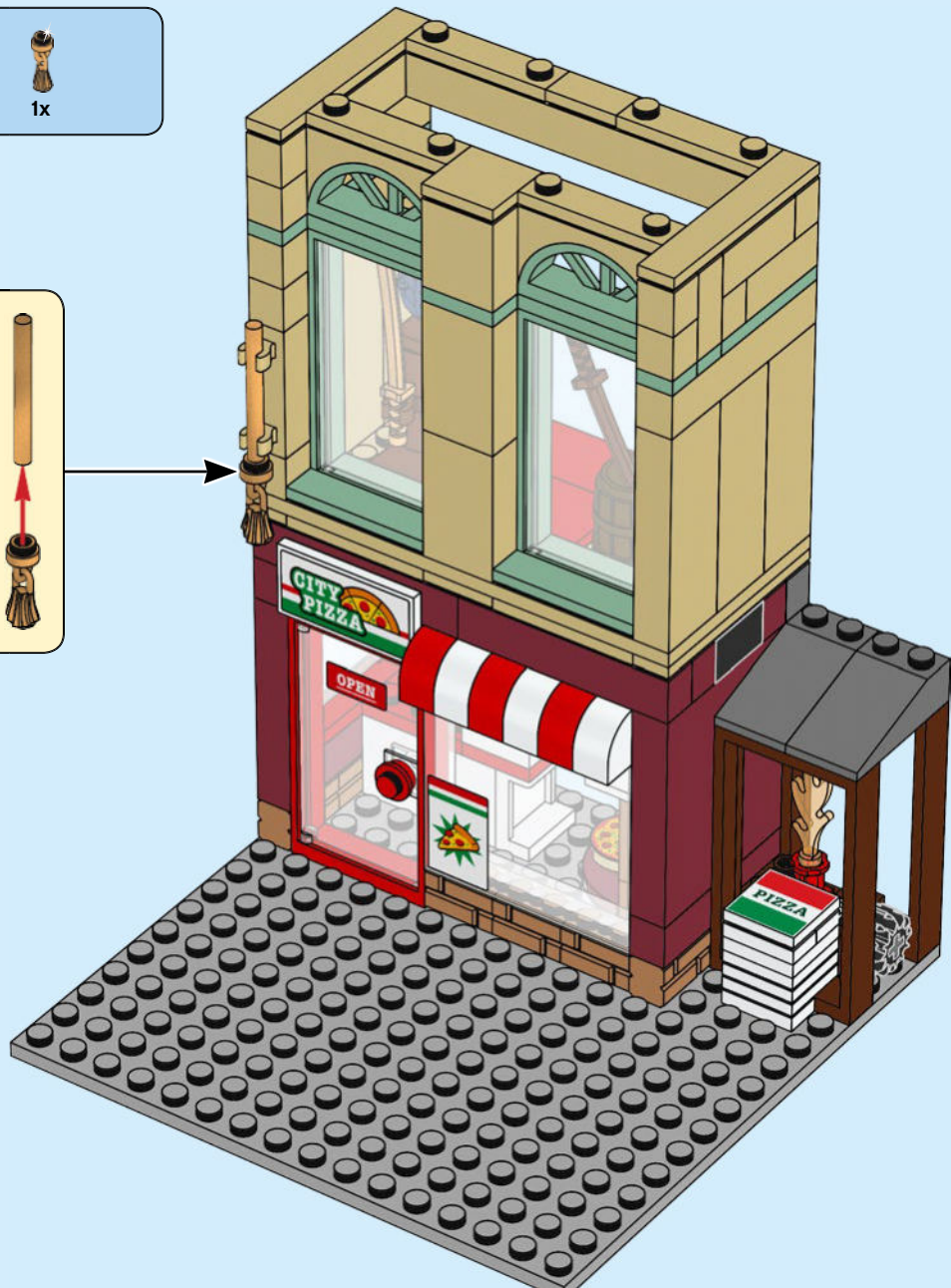
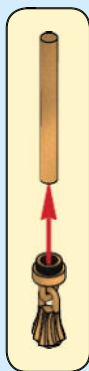



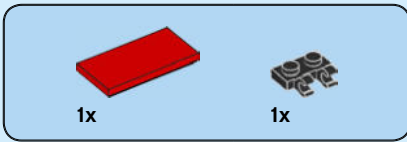

78

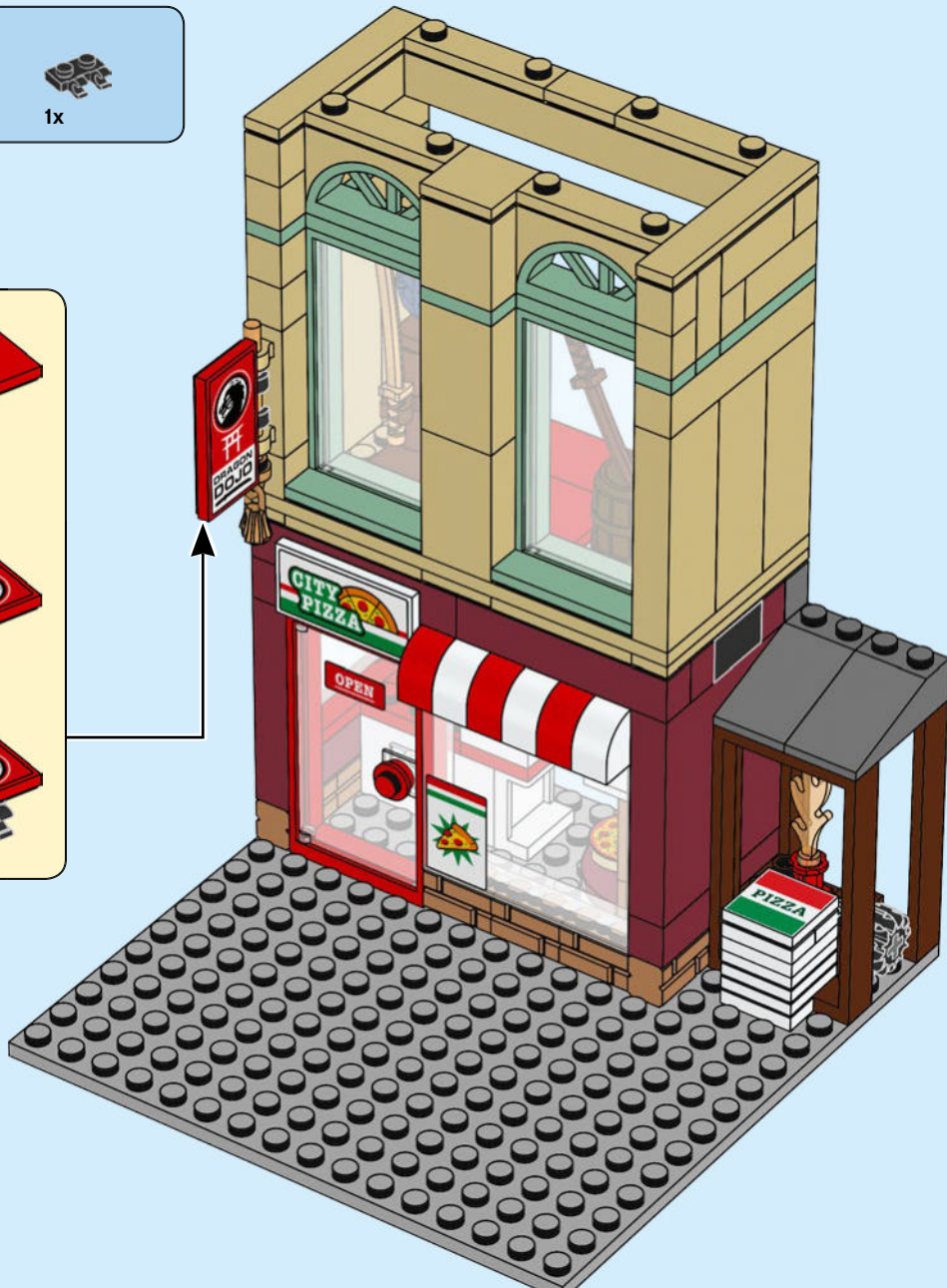
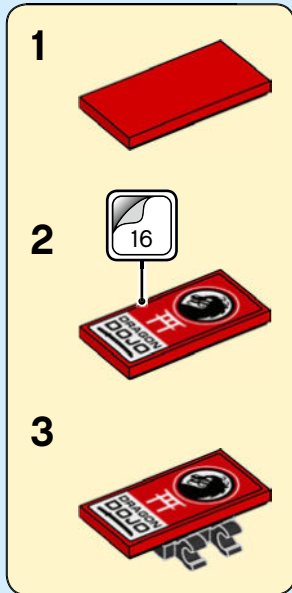

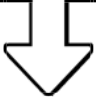
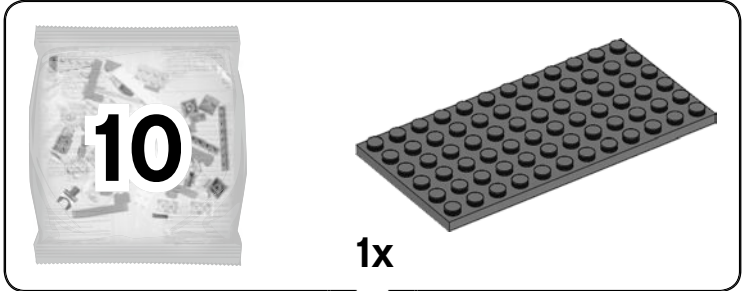

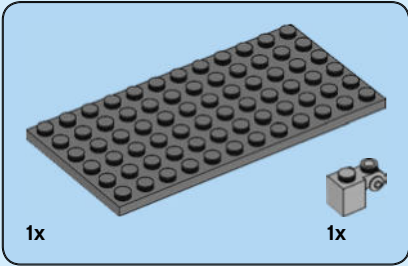
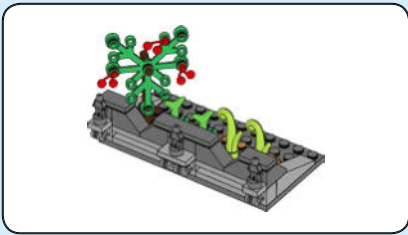

79

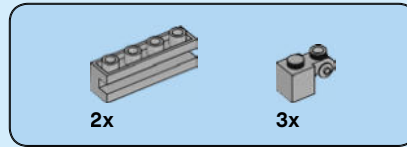
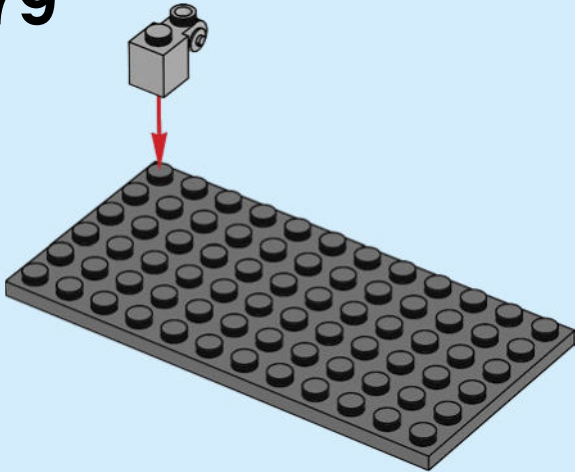

80

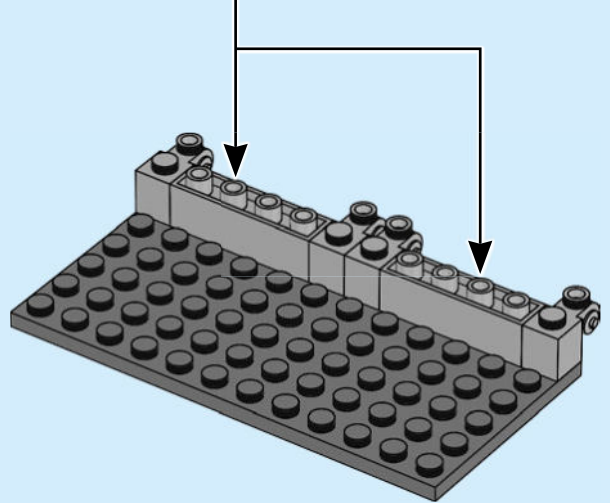
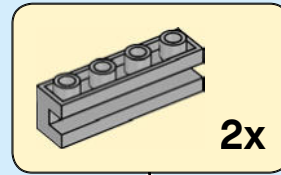



2x

81

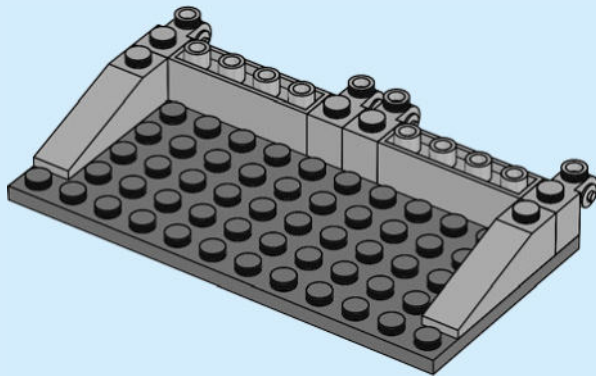



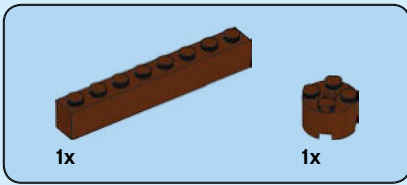

82

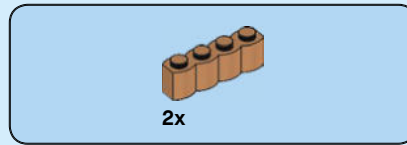
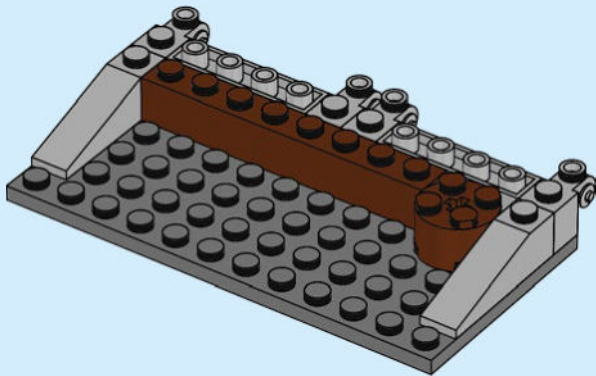

83

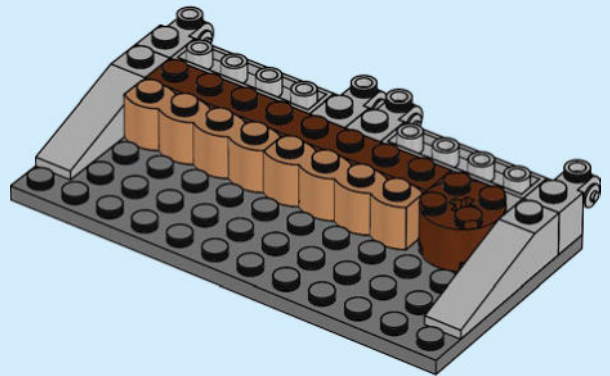



2x

84

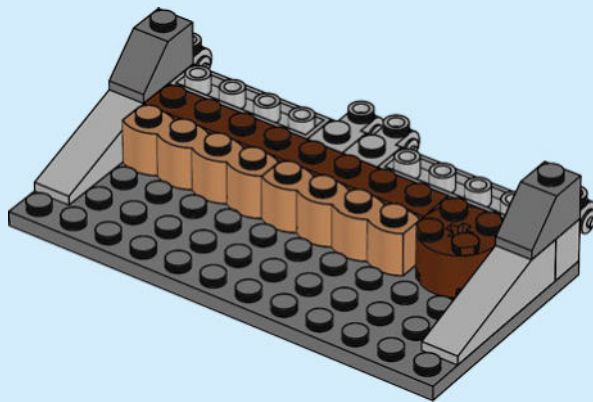

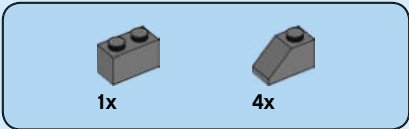

85

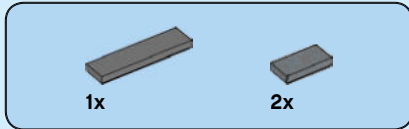
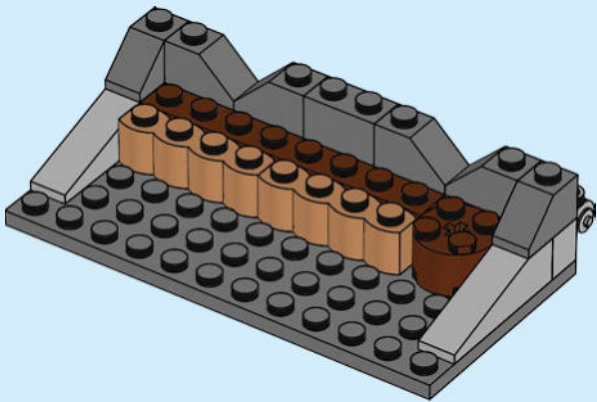

86

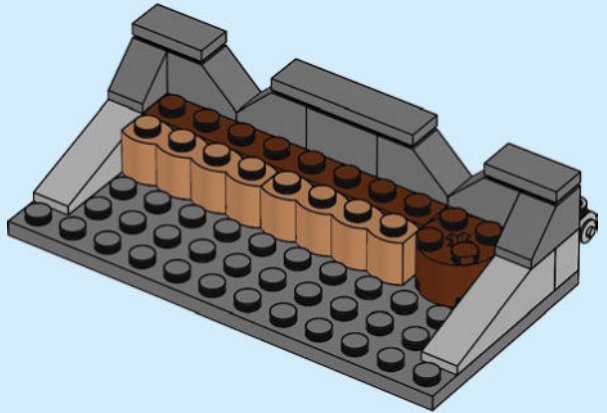



2x



2x

87

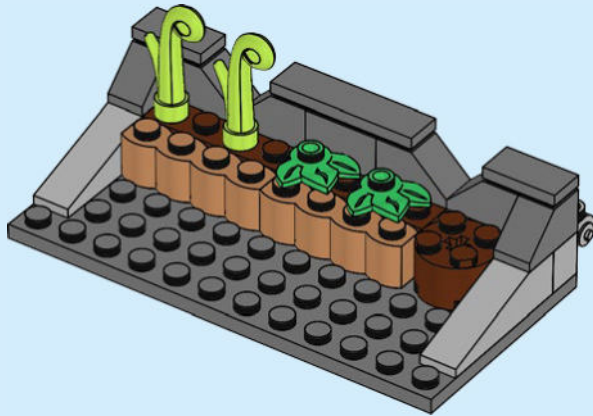



2x

88

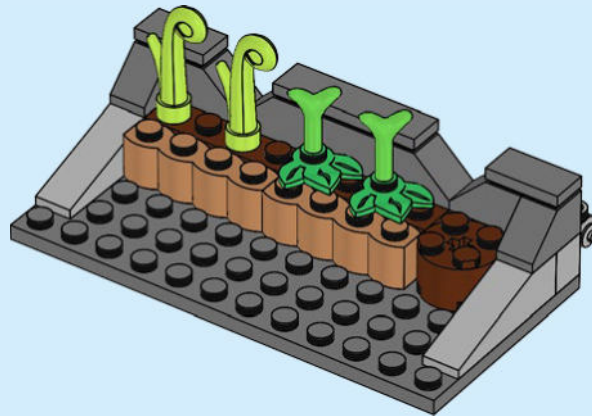

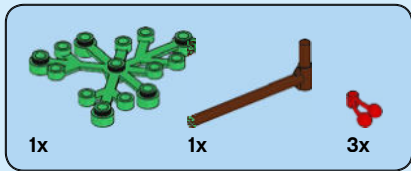

89

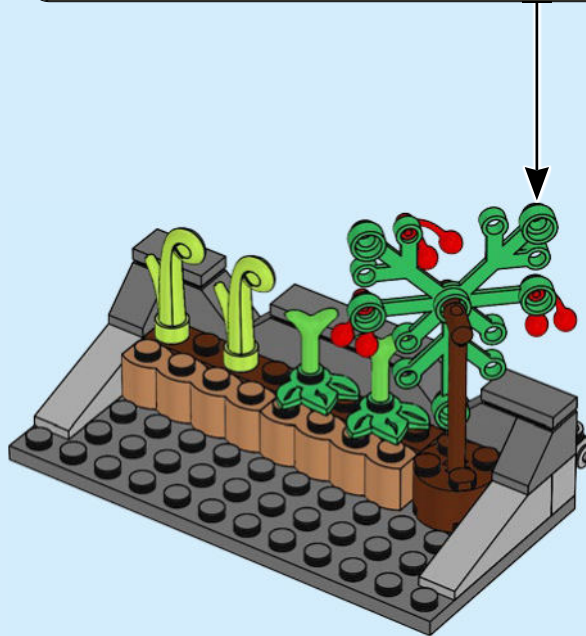
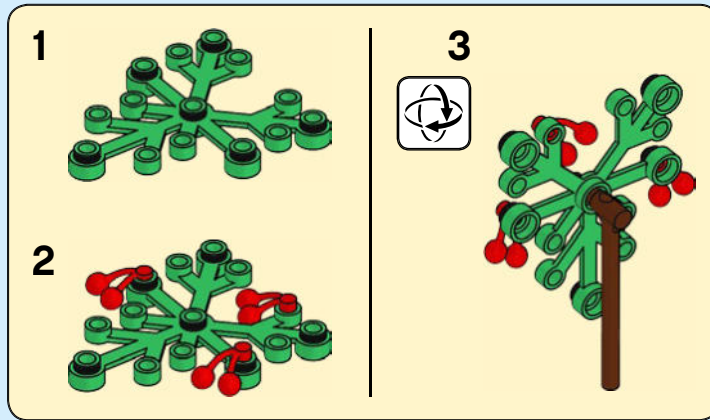

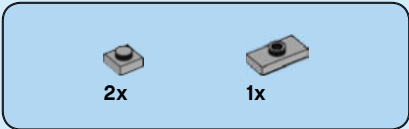

90

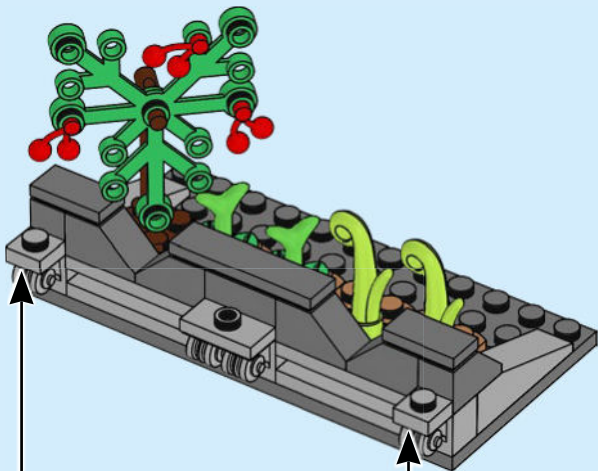
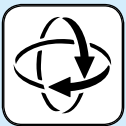

91

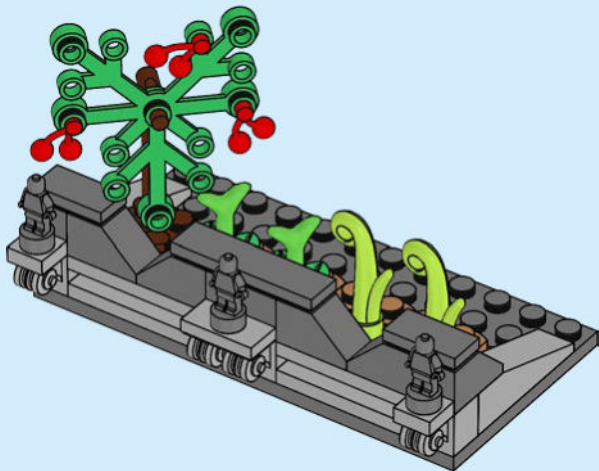

92





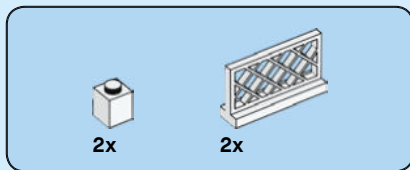

93

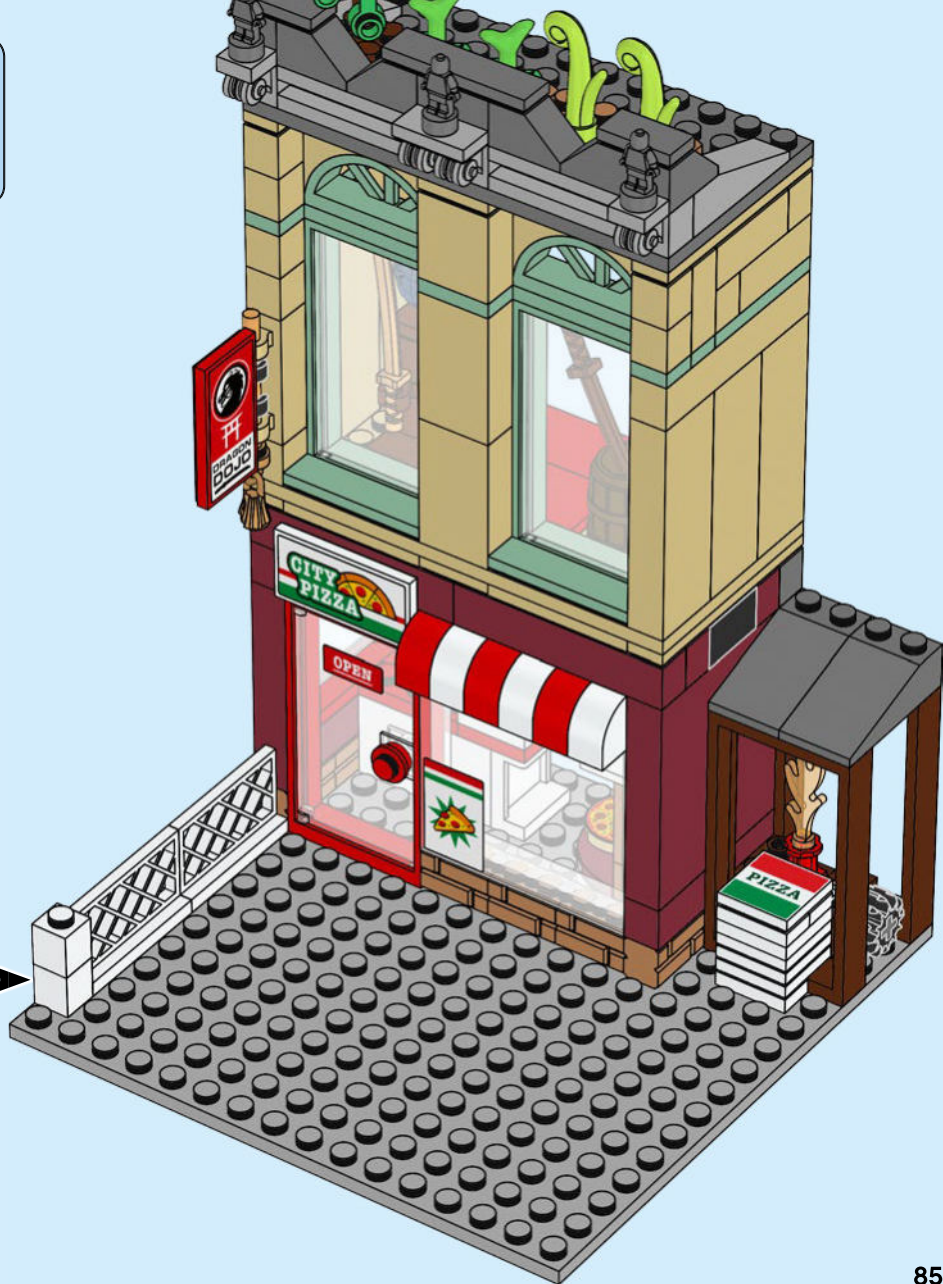
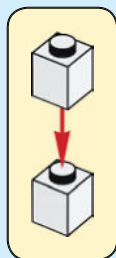

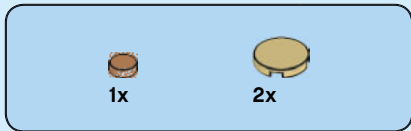

94

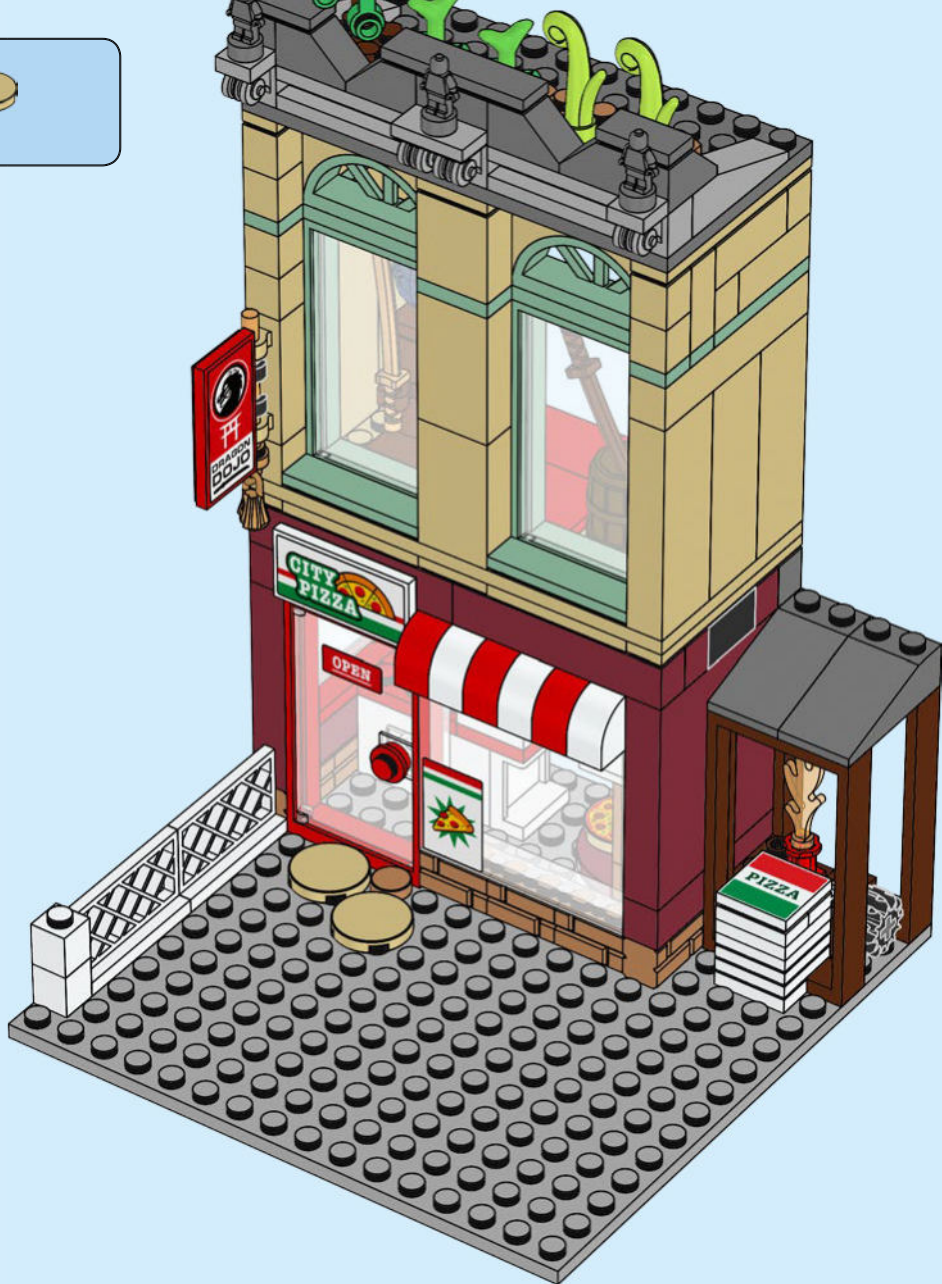

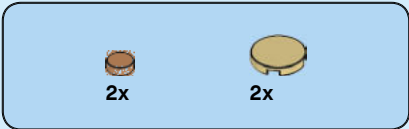

95





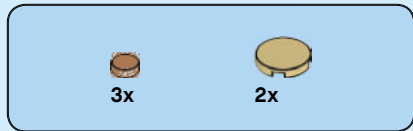

96

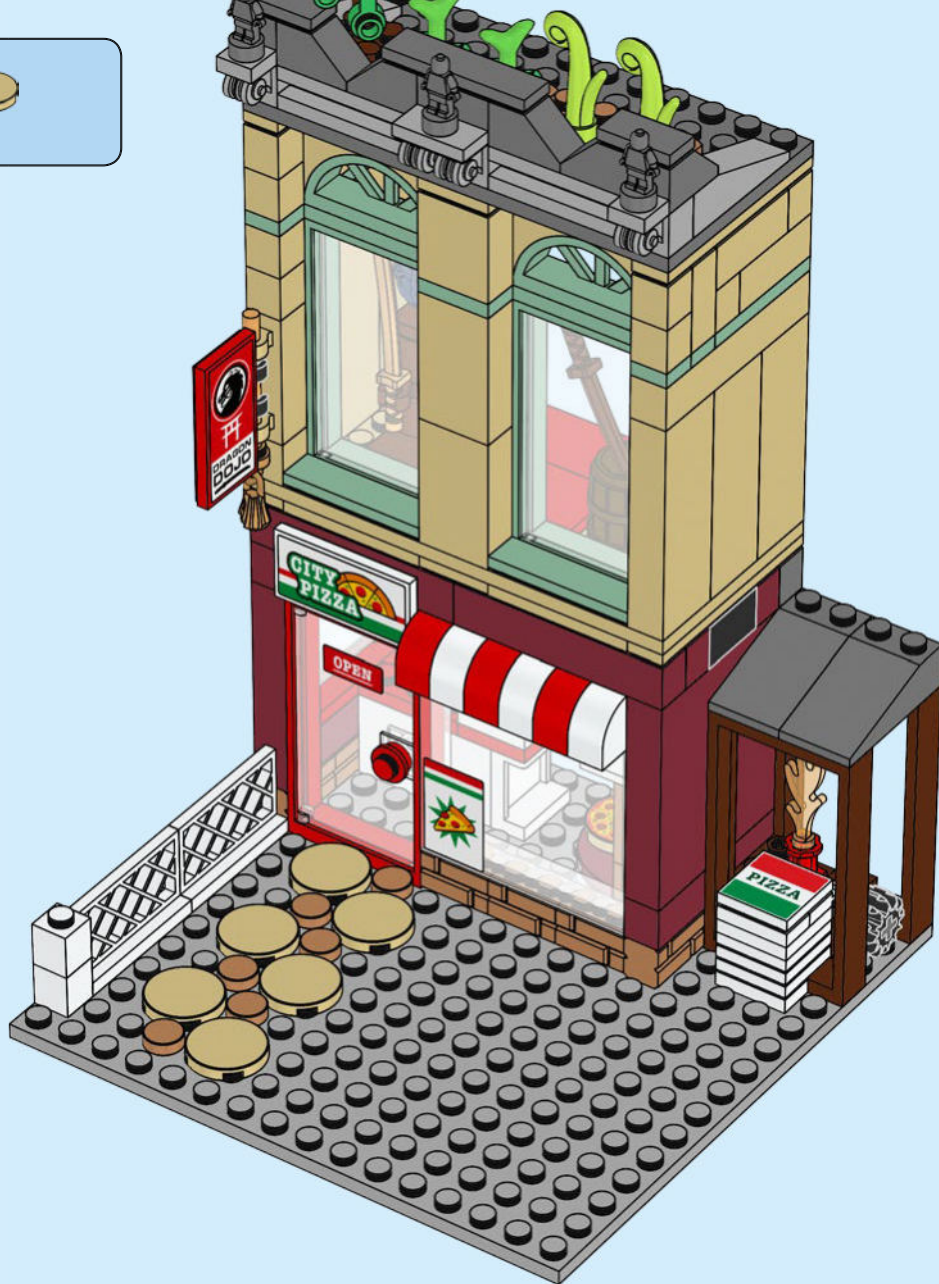

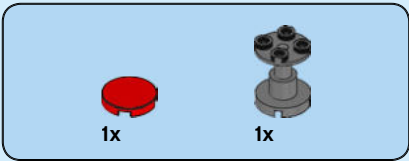

97

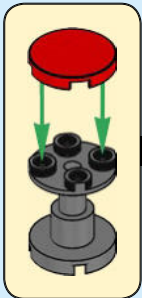

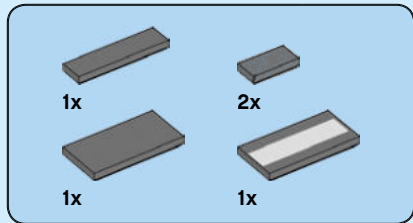

98





99

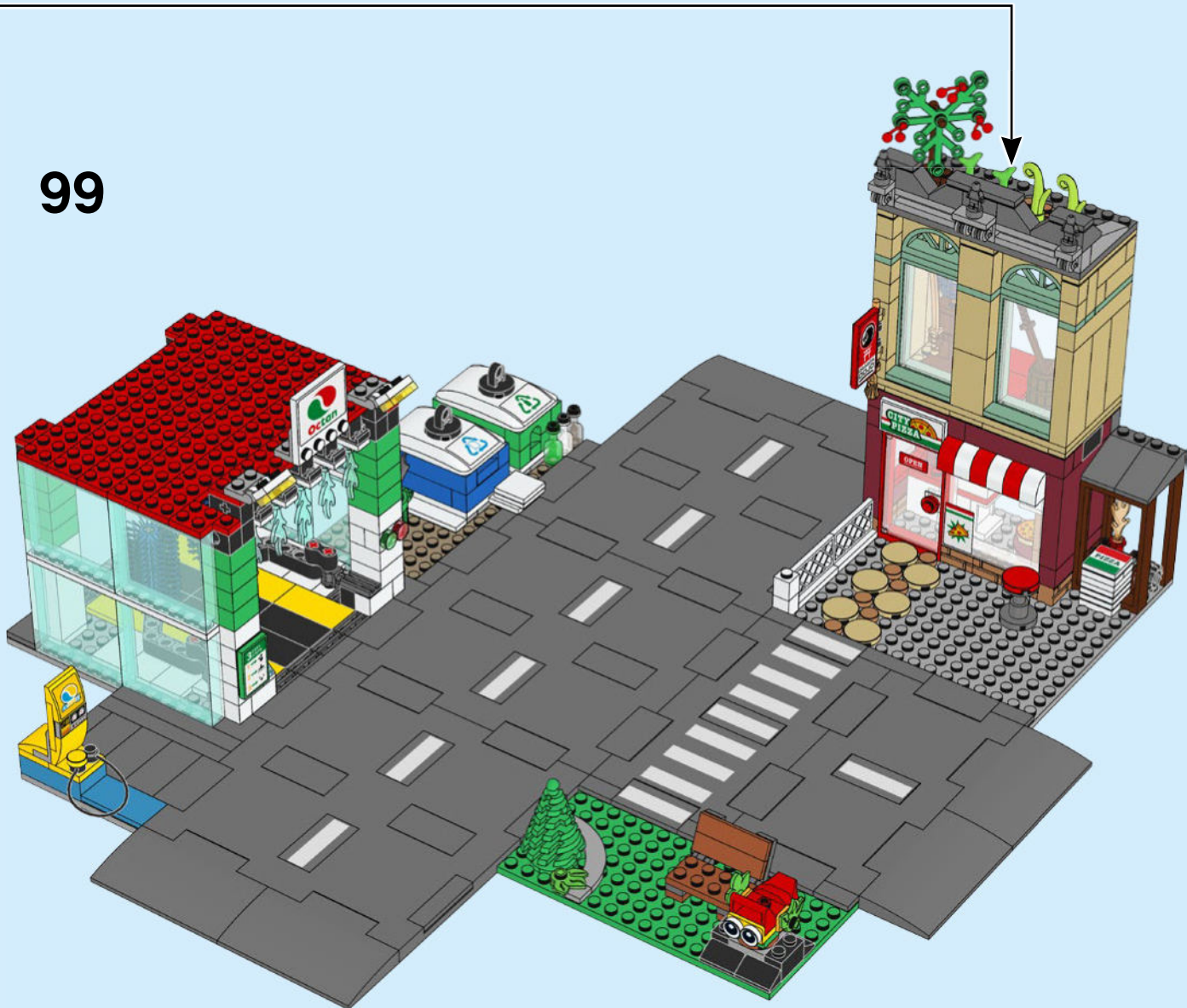

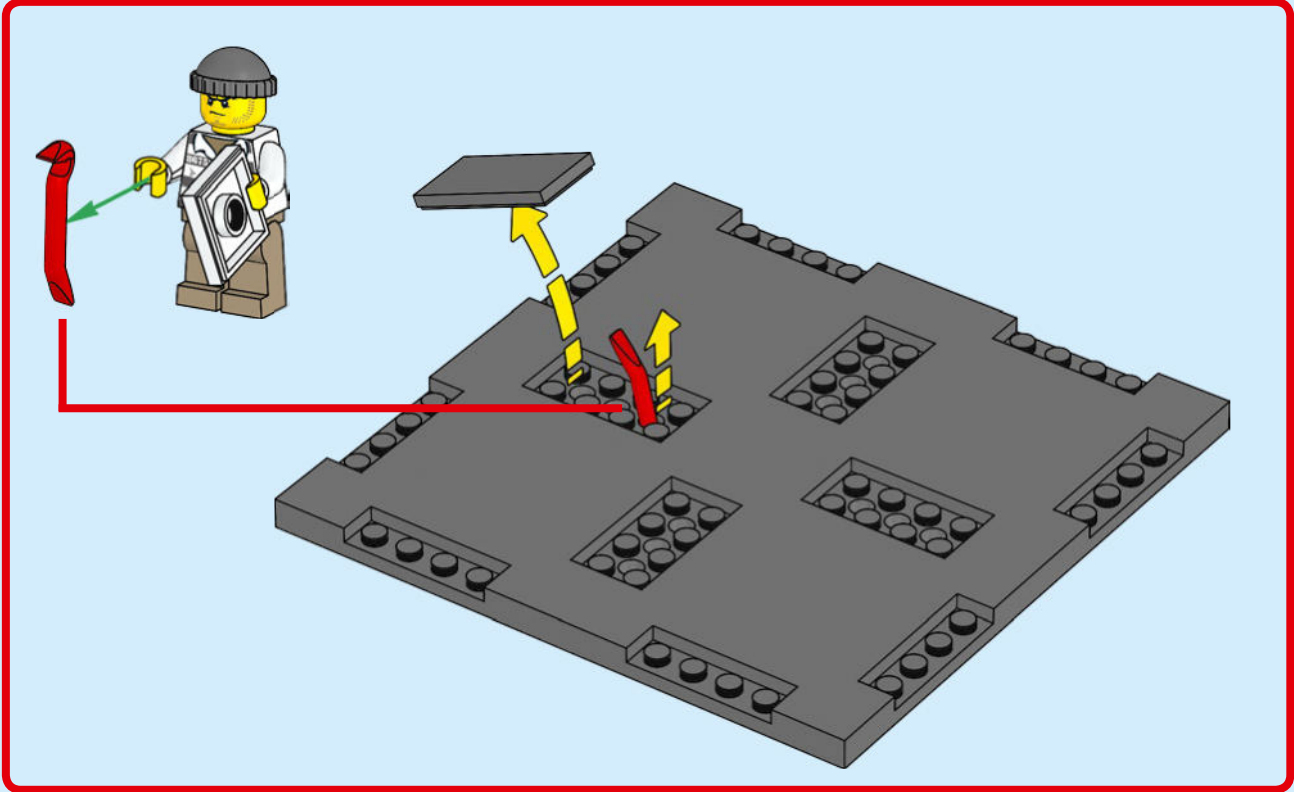





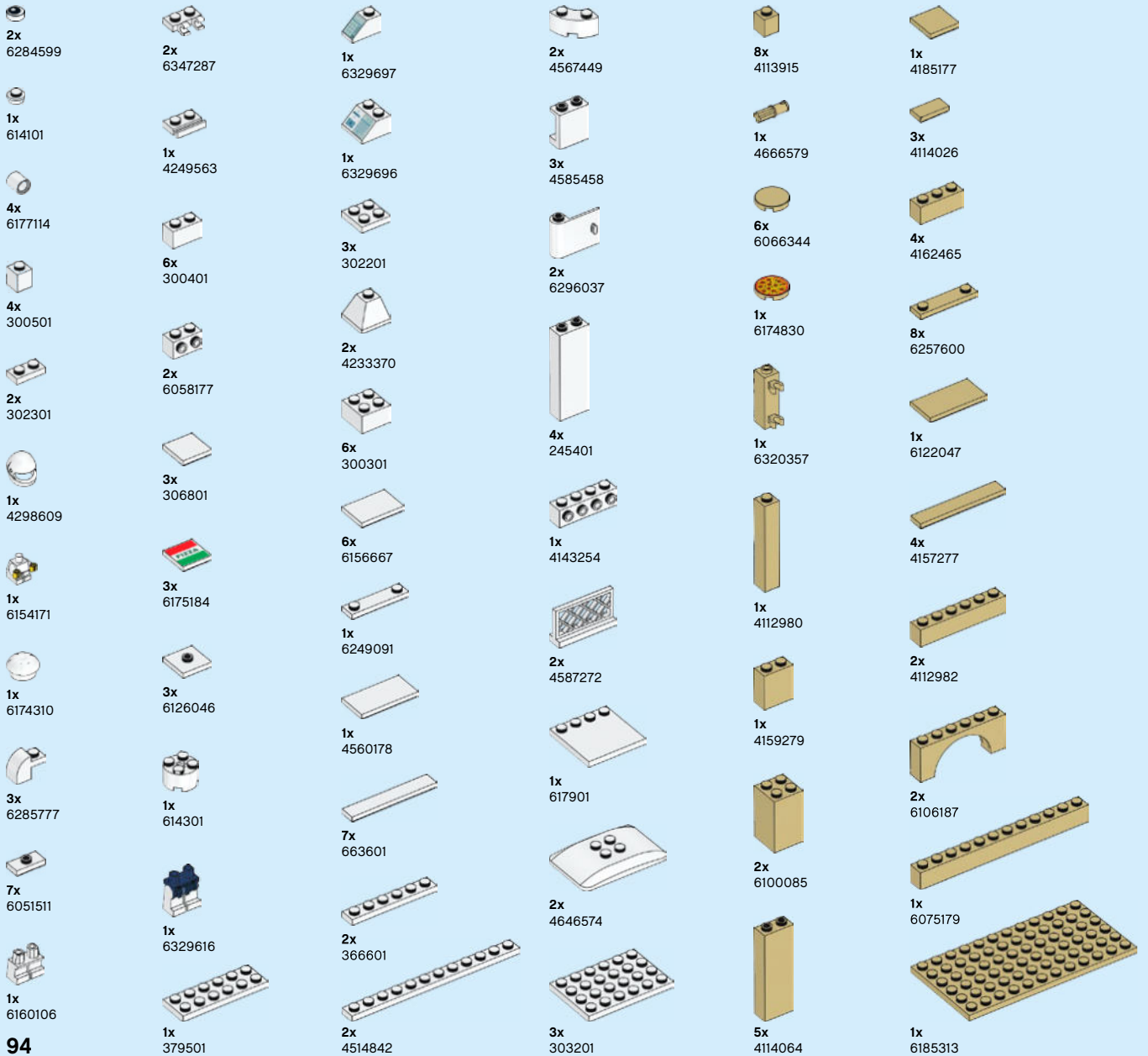

1x 614121  
3x 6100565  
2x 302421  
6x 4142865  
1x 6210269  
1x 6092565  
2x 302321  
1x 6347308  
1x 4220516  
1x 6066342  
3x 6184782  
1x 243221  
2x 302221  
1x 362321

1x 242021  
1x 4188189  
1x 4599453  
3x 4560179  
1x 300221  
1x 6138800  
1x 6262946  
1x 6203729  
1x 4255035  
5x 428221

2x 300523  
1x 4651236  
1x 6092582  
1x 243223  
1x 243123  
1x 4212411  
4x 301023  
2x 6331572  
4x 6270144  
1x 6055328  
1x 300923

1x 9566  
1x 4586547  
1x 4586544  
1x 9341  
2x 300528  
2x 6229130  
1x 74040  
1x 4107736  
16x 300328  
1x 6288100

1x 4546705  
1x 6331592  
1x 302128  
1x 6171069  
3x 4112838  
1x 4111844  
1x 6268823  
1x 6266968  
1x 4610602



4x  
6055351



1x  
6158405



6x  
6284589



2x  
6057986



9x  
4656783



2x  
4651232



1x  
6174192



2x  
6206809



2x  
6153538

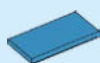

1x  
6206312



1x  
4655172

96



5x  
6258607



9x  
6240212



2x  
6109808



4x  
6182261



2x  
4119479



2x  
6188696



1x  
6325398



2x  
6134251



1x  
4616027



2x  
4570877



2x  
6074893



1x  
4535928



5x  
6240225



1x  
6273627



2x  
6240211



1x  
6244785



1x  
6247372



2x  
6253684



1x  
4267425



5x  
6167739

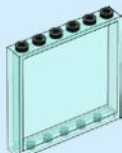

8x  
6245257



1x  
6274742



1x  
6247364



4x  
6245250



1x  
6247369



1x  
6253734



2x  
6256058



1x  
6247362



1x  
6245195

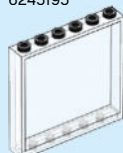

1x  
6245253



1x  
6336408



7x  
6068996



2x  
4121739



2x  
6078590



2x  
4118787



3x  
4160593



2x  
4118782



4x  
4158355



2x  
4173332



1x  
6224785



1x  
6240515



1x  
6152229



1x  
6278987



1x  
6312730



2x  
4541376



2x  
6172632



3x  
6052777















4x  
4541528















2x  
6161299



1x  
6267408

1x  
6204394  
  
1x  
6284577  
  
2x  
6271167  
  
1x  
6223882  
  
1x  
6329612  
  
1x  
6329613  
  
1x  
6270320  
  
1x  
6270397  
  
1x  
6224063  
  
1x  
6329589  
  
1x  
6211710  
  
1x  
6018687  
  
1x  
302324  

1x  
6057458  
  
1x  
4501232  
  
1x  
302224  
  
1x  
6224666  
  
3x  
6079007  
  
1x  
6283797  
  
1x  
6335898  
  
1x  
6056258  
  
1x  
6153141  
  
1x  
6152679  
  
2x  
6267090  
  

1x  
6266283  
  
1x  
302124  
  
6x  
4560181  
  
1x  
6186675  
  
2x  
4504382  
  
1x  
4177431  
  
1x  
6265699  
  
10x  
4548180  
  
2x  
4198367  
  
1x  
403226  
  
2x  
6010831  
  
2x  
4644456  
  
4x  
4508215  

1x  
6143335  
  
5x  
4144023  
  
6x  
241226  
  
1x  
6266320  
  
8x  
6178922  
  
1x  
306926  
  
2x  
366526  
  
2x  
6020193  
  
1x  
6310268  
  
2x  
6116990  
  
4x  
6064174  
  
2x  
6336989  
  
1x  
302226  

6x  
4568644  
  
1x  
303926  
  
2x  
242026  
  
2x  
4515368  
  
1x  
317626  
  
2x  
4260488  
  
6x  
4560182  
  
1x  
6301371  
  
2x  
6278125  
  
2x  
366626  
  
1x  
6064228  
  
1x  
379526  

1x  
4653049  
  
1x  
6298539  
  
1x  
244126  
  
1x  
6096955  
  
1x  
370826  
  
2x  
4107558  
  
1x  
302826  
  
1x  
6233539  
  
1x  
4524098  
  
1x  
4624163  

12



2x  
6236437



1x  
6092590



1x  
4211157



4x  
4211350



8x  
6126082



6x  
6018081



1x  
6167741



2x  
4211252



1x  
6214343



1x  
6066097



1x  
4226995



2x  
6013497



2x  
6245265



1x  
4211166



2x  
6331580



3x  
4654580



1x  
4211376



1x  
4560183



2x  
6252040



1x  
4565394



1x  
4609635



1x  
6329585



1x  
6163989



2x  
4211613



4x  
6254252



1x  
6196221



2x  
6284071



4x  
6211917



4x  
4211549



2x  
4211396



2x  
6249235



1x  
4221886



2x  
4211399



2x  
4244627



2x  
4211438



1x  
6118827



1x  
4221744



1x  
4211189



2x  
4211415



1x  
6337003



2x  
6262952



1x  
6329584



1x  
6059033

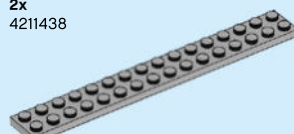

3x  
4211486



1x  
6194410



1x  
4263776



4x  
6011375



1x  
4166618

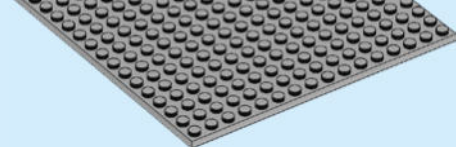

2x  
4620130



2x  
4211180



1x  
6123037



1x  
6329619



6x  
4211764



  
1x  
6274711

  
1x  
6147169

  
1x  
6116596

  
2x  
6099189

  
1x  
4655080

  
2x  
6100234

  
2x  
6138738

  
2x  
6192923

  
2x  
6342692

  
2x  
6099187

  
1x  
6207255

  
2x  
6331588

  
2x  
6335834

  
1x  
4162916

  
1x  
6331573

  
3x  
6299494

  
1x  
4210934

  
1x  
6106283

  
2x  
6184977

  
1x  
4211088

  
1x  
6331836

  
12x  
4210631

  
8x  
4211052

  
6x  
4211135

  
4x  
6117972

  
1x  
6347464

  
2x  
6336990

  
4x  
6247784

  
2x  
4521187

  
1x  
6335812

  
1x  
6332022

  
2x  
4211043

  
1x  
4211006

  
1x  
6083620

  
1x  
4648256

  
11x  
4211053

  
10x  
6329624

  
26x  
4560184

  
2x  
4210637

  
2x  
4508553

  
1x  
6271647

  
2x  
4211008

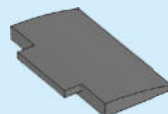
  
6x  
6325420

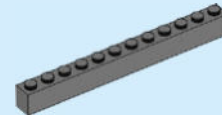
  
1x  
4210798

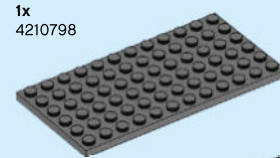
  
1x  
4256149

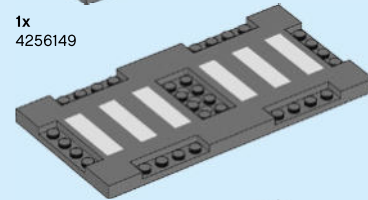
  
1x  
6328358

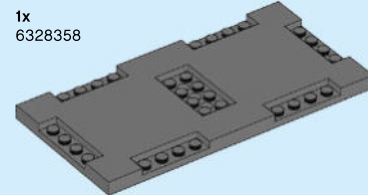
  
1x  
6325431

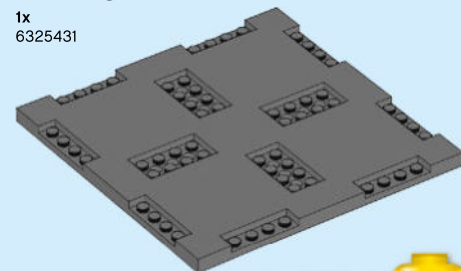
  
3x  
6325635



Customer Service

Kundenservice

Service Consommateurs

Servicio Al Consumidor

LEGO.com/service or dial

  
: 00800 5346 5555  
: 1-800-422-5346



# WIN

GO TO [WWW.LEGO.COM/PRODUCTFEEDBACK](http://WWW.LEGO.COM/PRODUCTFEEDBACK) AND  
GIVE US YOUR SHORT **FEEDBACK** ABOUT THIS  
LEGO® SET FOR A CHANCE TO WIN  
A COOL LEGO PRIZE.

Terms & Conditions apply

## [LEGO.com/productfeedback](http://LEGO.com/productfeedback)

### GEWINNE

Erzähle uns auf  
[www.LEGO.com/productfeedback](http://www.LEGO.com/productfeedback)

etwas über die Erfahrungen, die du mit  
diesem LEGO® Set gemacht hast, und  
sichere dir die Chance auf einen coolen  
LEGO Preis!

Es gelten die Teilnahmebedingungen

### GAGNE

Rends-toi sur  
[www.LEGO.com/productfeedback](http://www.LEGO.com/productfeedback)

et donne-nous quelques commentaires  
sur ce produit LEGO® pour avoir une  
chance de gagner un prix LEGO !

Voir Conditions Générales

### GANA

Visita  
[www.LEGO.com/productfeedback](http://www.LEGO.com/productfeedback)

y envíanos tu opinión acerca de este set  
LEGO®. ¡Participarás en el sorteo de un  
premio LEGO!

Términos y Condiciones aplicables

### 获取奖品

登录  
[www.LEGO.com/productfeedback](http://www.LEGO.com/productfeedback)

给出关于此乐高®套装的简短反馈，  
就有机会获得炫酷乐高奖品

《条款及条件》适用

LEGO and the LEGO logo are trademarks of the LEGO Group. ©2021 The LEGO Group.

6354579