



# CITY

60290





- 1** Scan the code on the front cover  
 Scanne den Code auf der Titelseite  
 Scanne le code sur la page de couverture  
 Scanner le code sur la page couverture  
 Scansiona il codice sulla copertina  
 Escanea el código de la portada  
 Faz scan do código na frente da capa  
 Olvasd be a borítón látható kódot!  
 Noskenē kodu uz priekšējā vāka  
 扫描封面上的二维码



- 2** Get Instructions PLUS  
 Hol dir Instructions PLUS  
 Obtien les instructions PLUS  
 Obtenir les Instructions PLUS  
 Scarica Instructions PLUS  
 Descubre Instructions PLUS  
 Obtém Instruções PLUS  
 Szerezd be az Instructions PLUS kiegészítőt!  
 Saņem "Instructions PLUS"  
 获取更多说明

**LEGO.com/apps**

Check for compatibility  
 Kompatibilität prüfen  
 Vérifier la compatibilité  
 Controlla la compatibilità  
 Comprueba tu compatibilidad

Verificar a compatibilidade  
 Ellenőrizd a kompatibilitást  
 Pārbaudīt saderību  
 检查兼容性

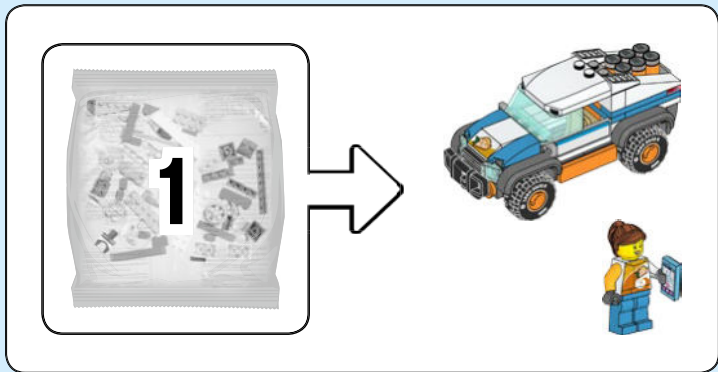

4

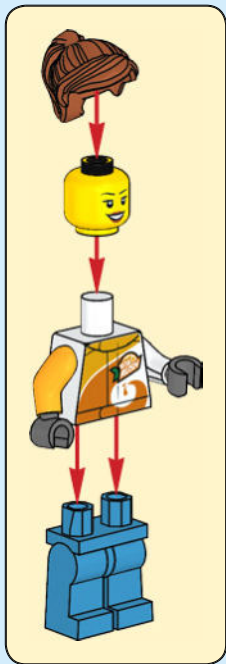

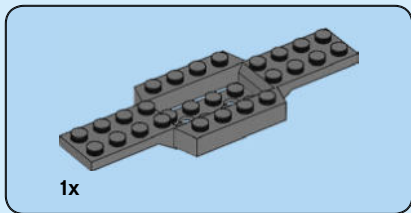

1

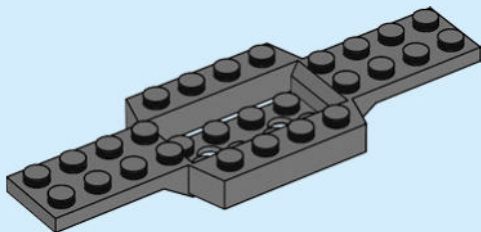



2x

2

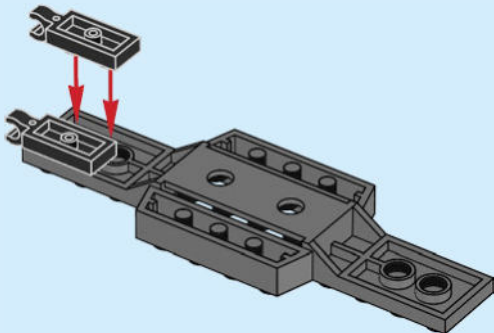
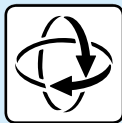

6



1x

**3**

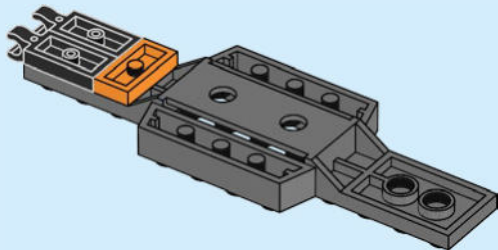



1x

4

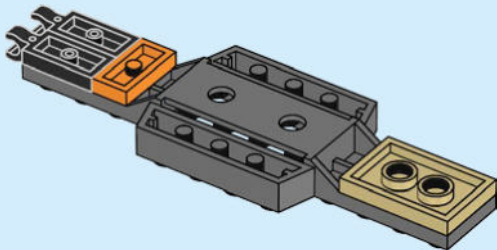

8





2x

5

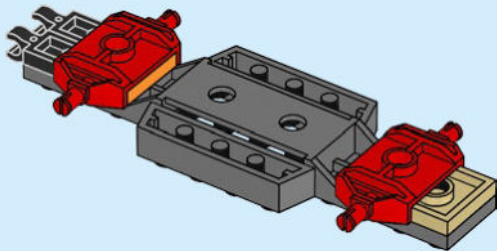

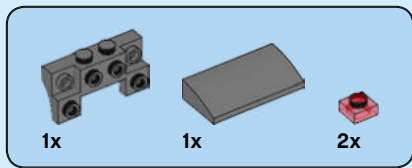

6

1

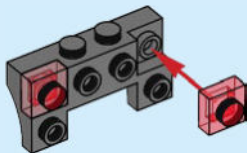

2

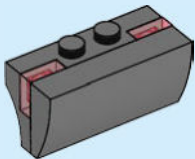

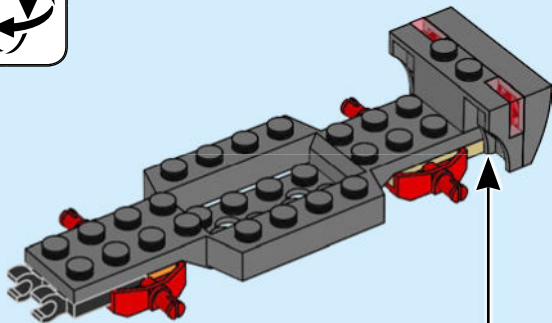
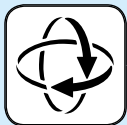



1x

7

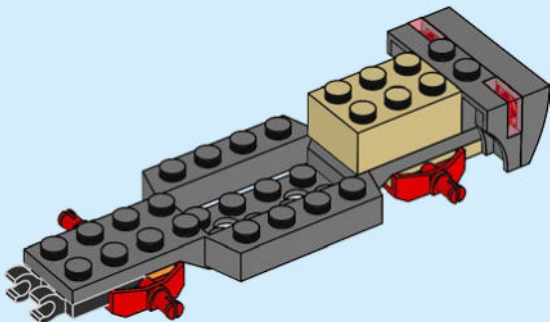

12



4x

8

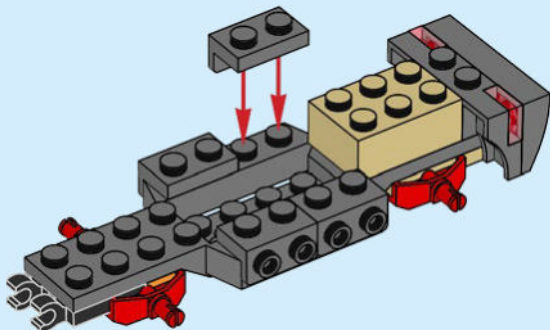

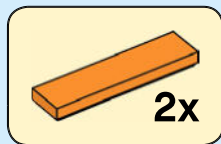
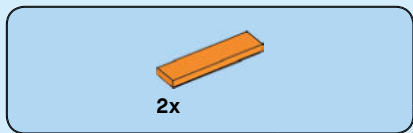

9

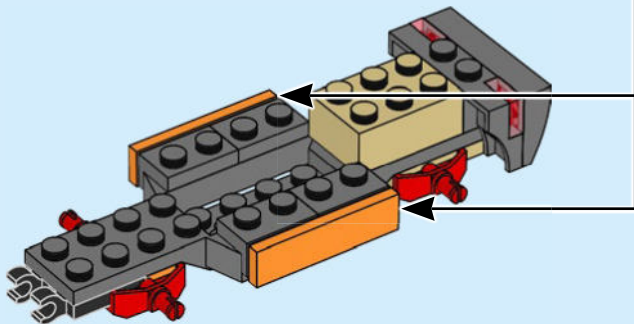

14



1x

10

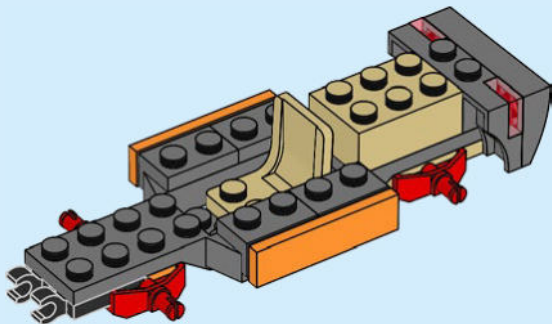



1x

11

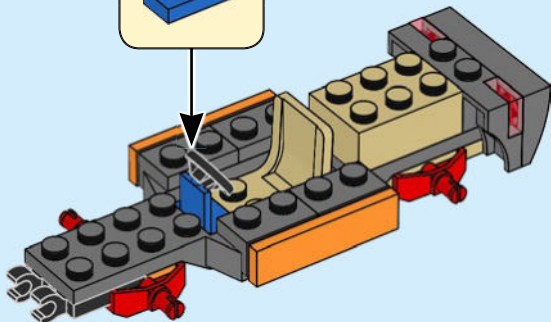

16





1x



1x

# 12

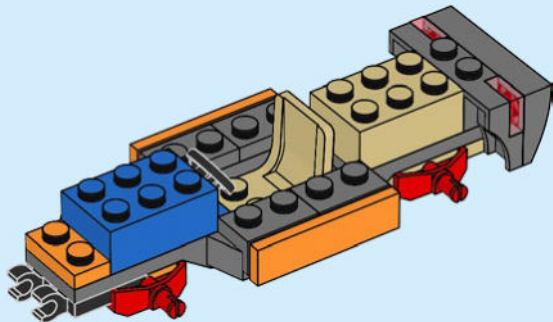



2x

13

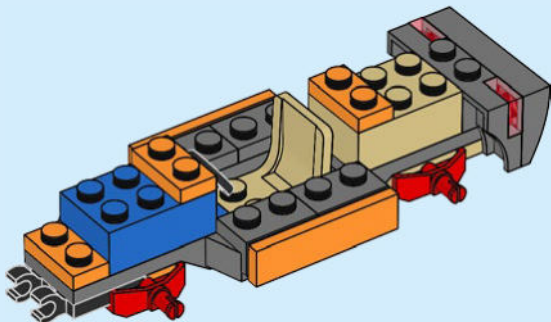

18

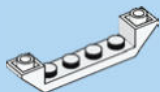

2x

14

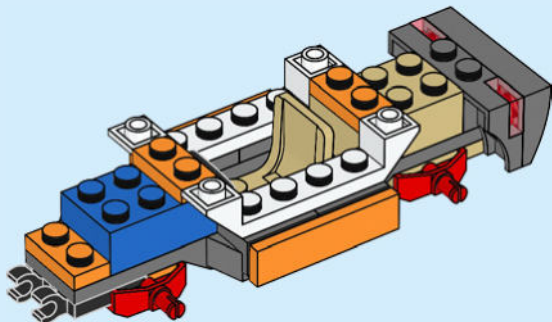

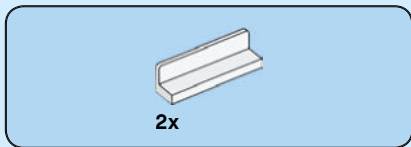
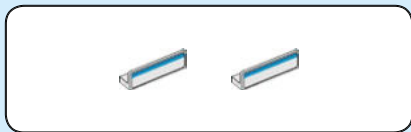

15

1

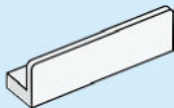

20

2

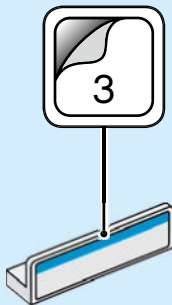

2x

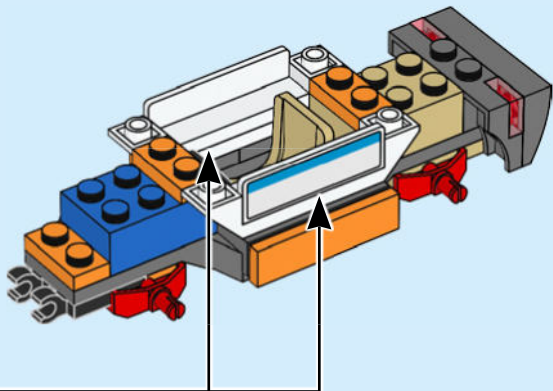



4x

16

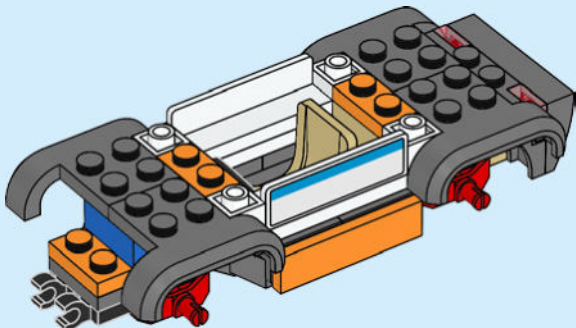

22



1x



1x

# 17

1

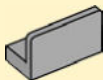

2



1



2



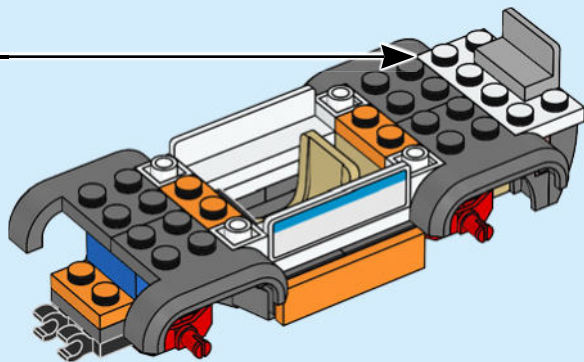



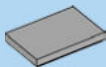

1x

18

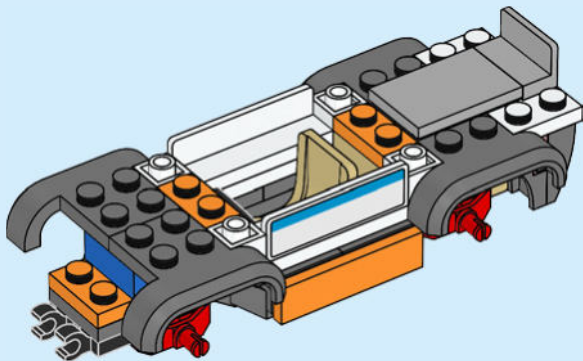



3x

# 19

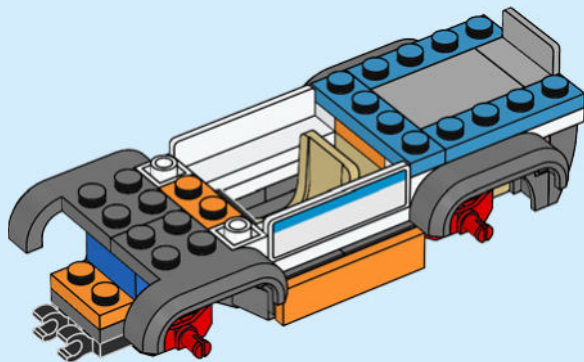



1x



2x



2x

# 20

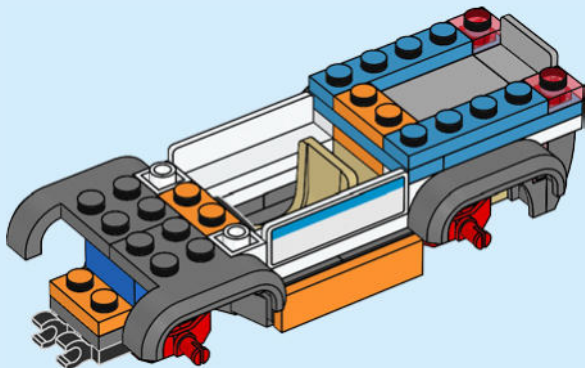



1x

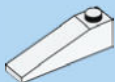

2x

# 21

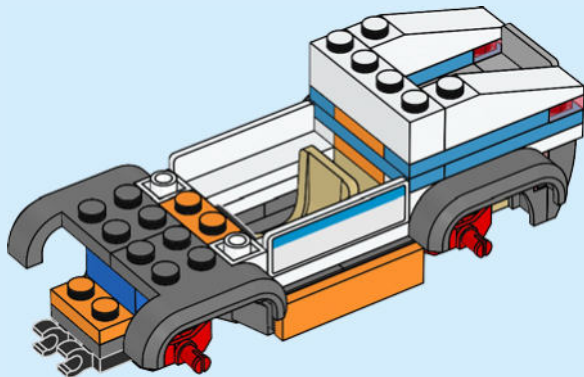



2x



2x

# 22

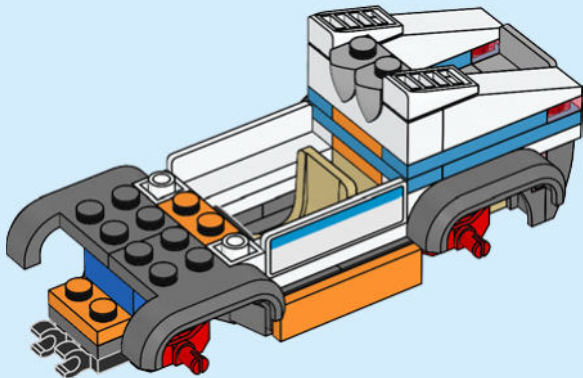

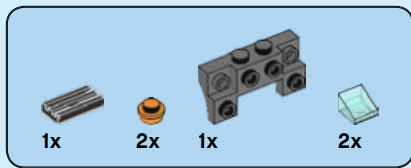

# 23

## 1

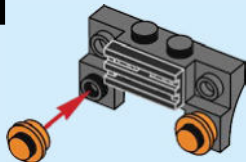

## 2

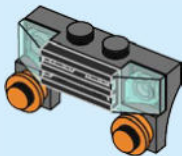

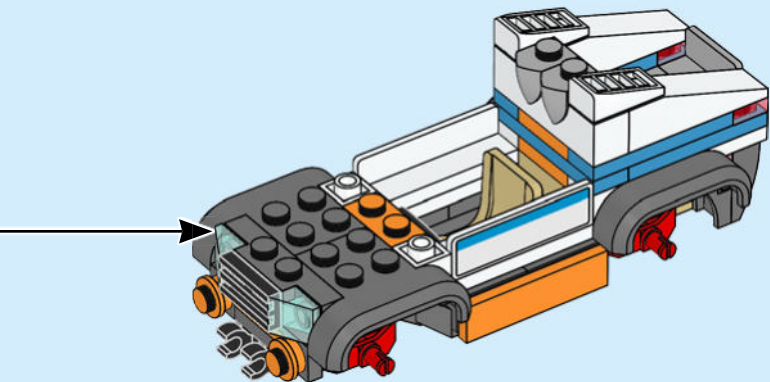



2x

# 24

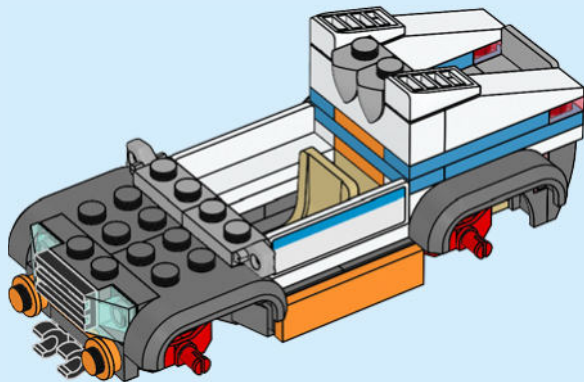





1x



1x

# 25

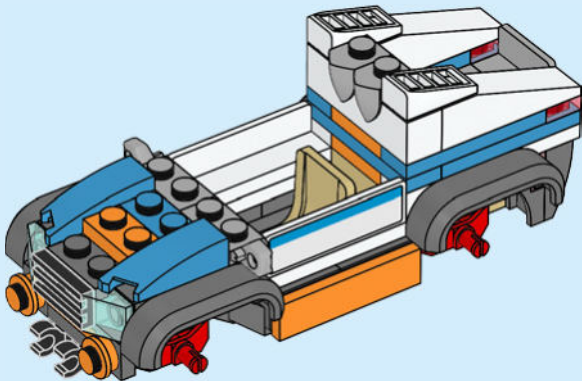



1x

# 26

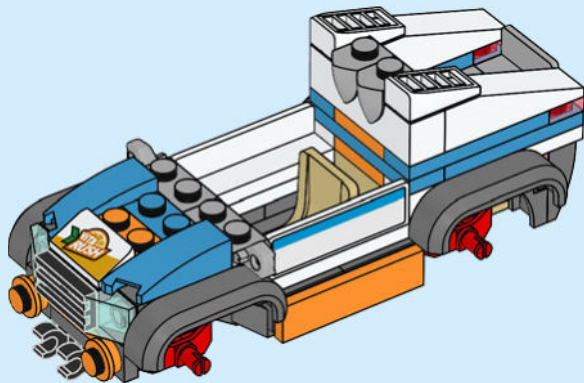

34



1x

27

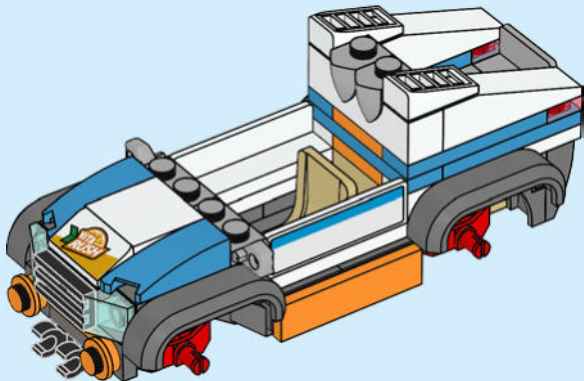



1x

28

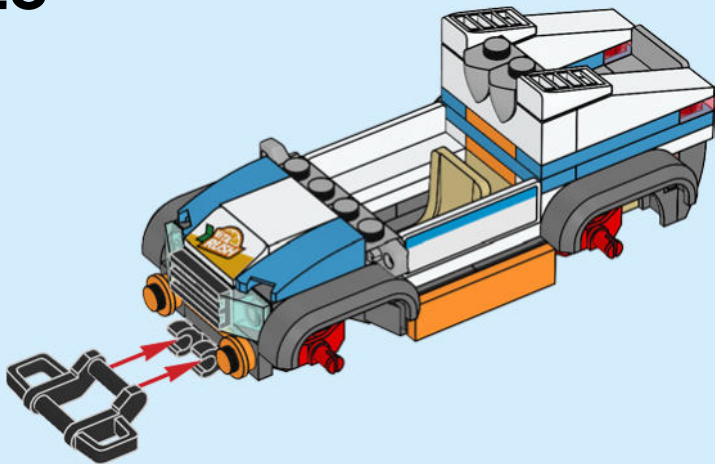

36

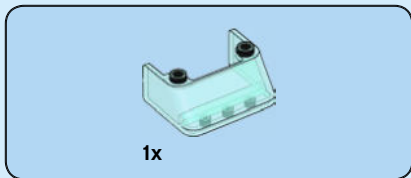

29

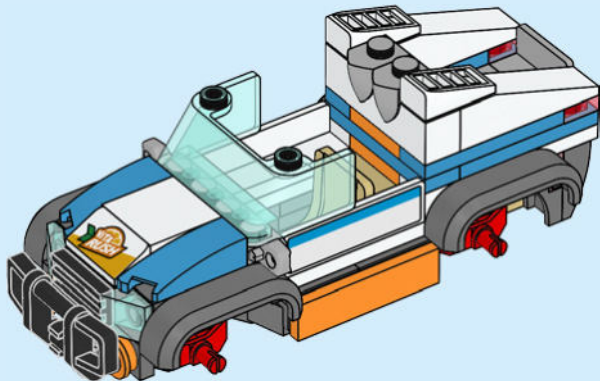



1x

30

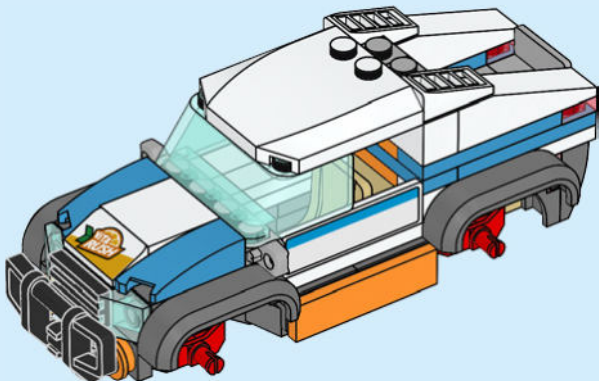

38



4x



4x

# 31

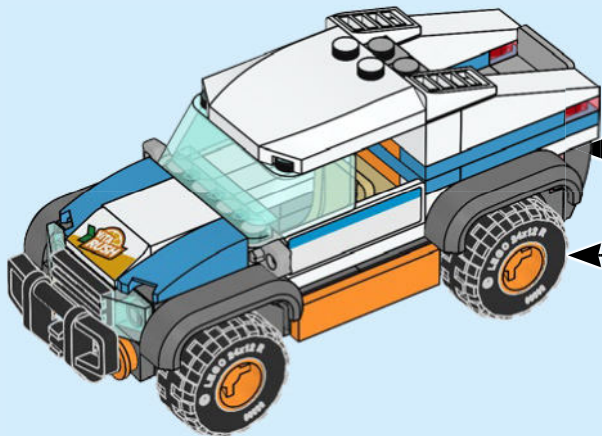

4x



1x



6x



6x

# 32

## 1



## 2



## 3





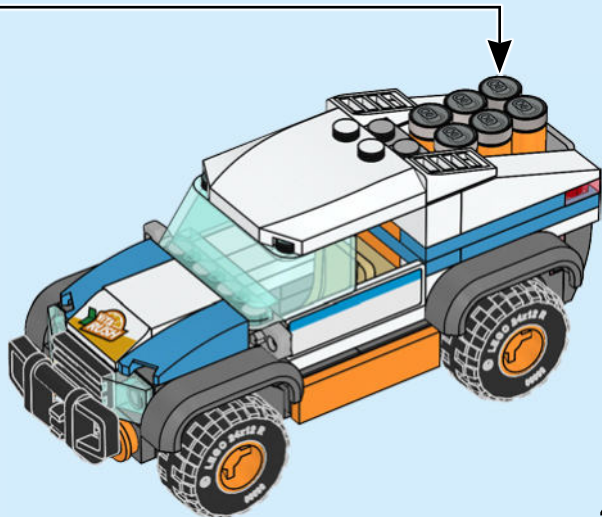

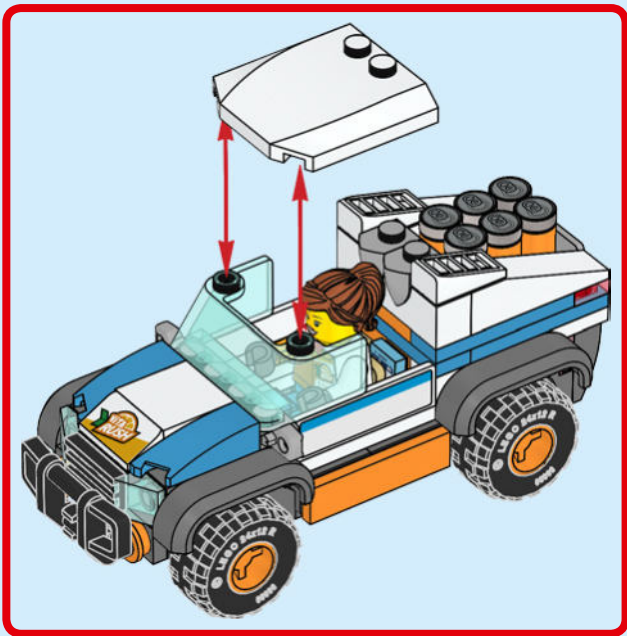





# CITY

## CONNECT YOUR CITY

Connect your city  
Verbinde deine Stadt  
Connecte ta ville  
Unisci la tua città  
Conecta tu ciudad  
Une a tua cidade  
Bóvítsd a váróst  
Savieno savas  
pilsētas daļas  
连接你的城市



60292



60291



60290



60304

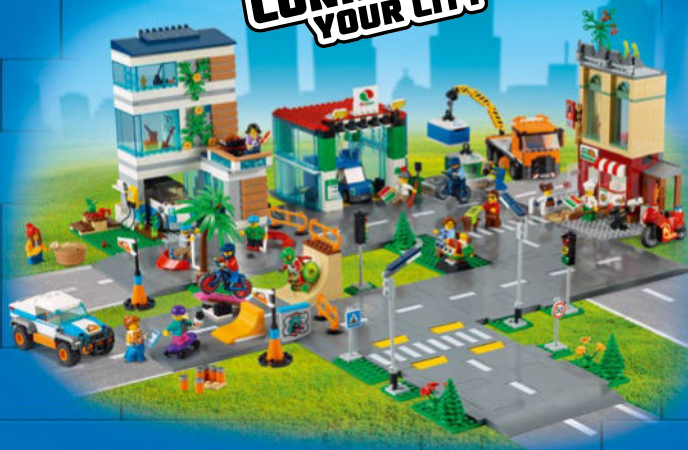



CITY

60290



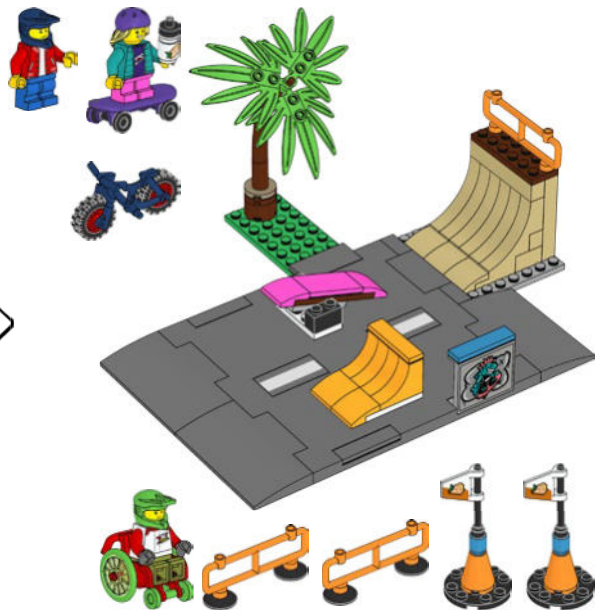
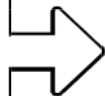
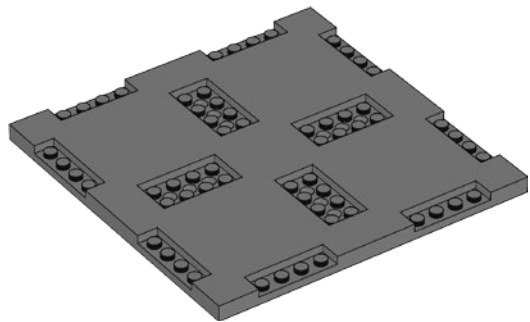

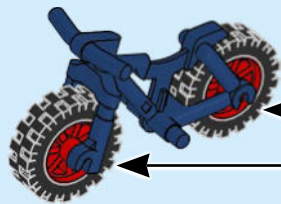
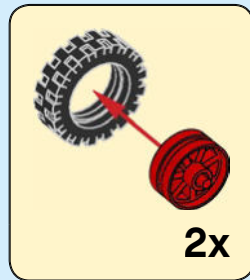
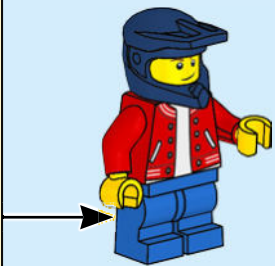
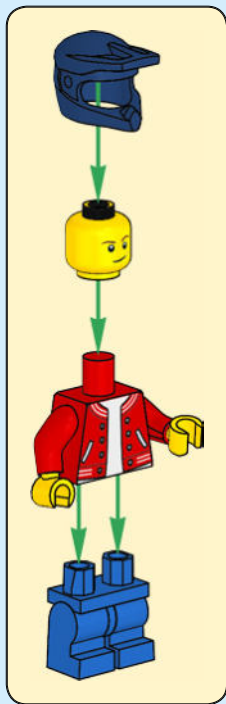



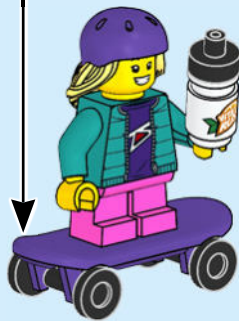
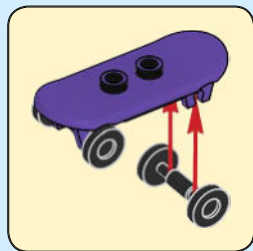
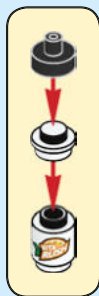



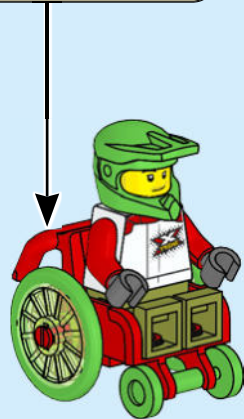
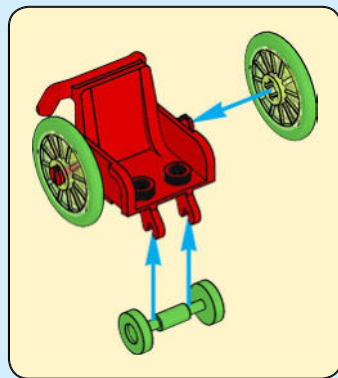

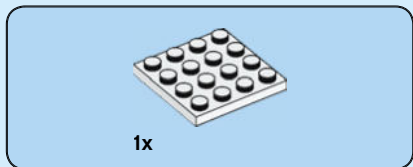
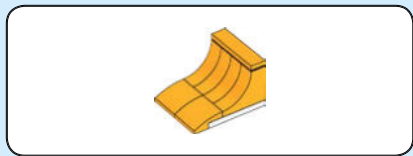

**1**

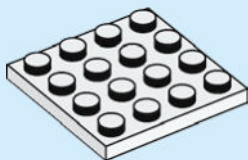

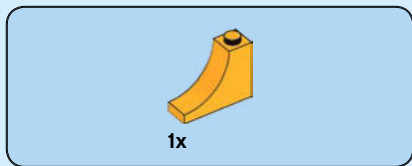

**2**

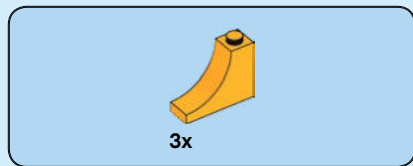
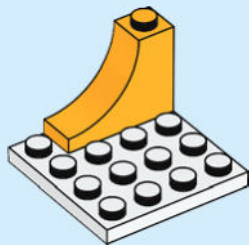

**3**

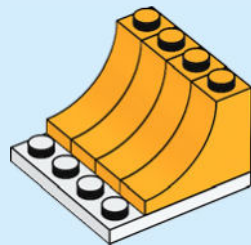

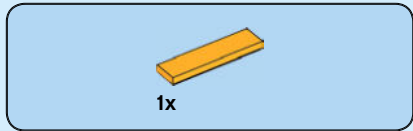

4

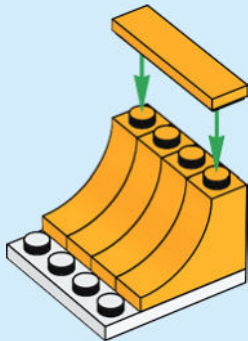

5

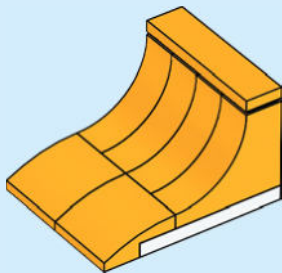

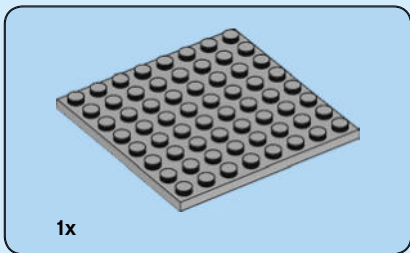
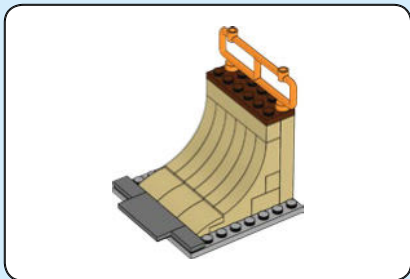

**1**

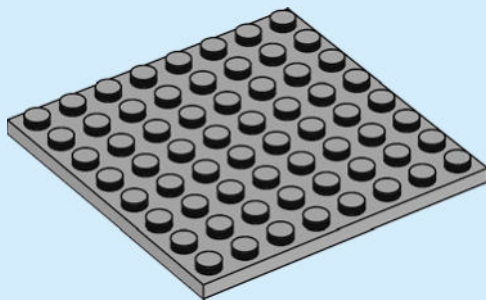

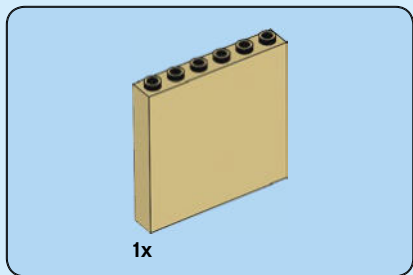

2

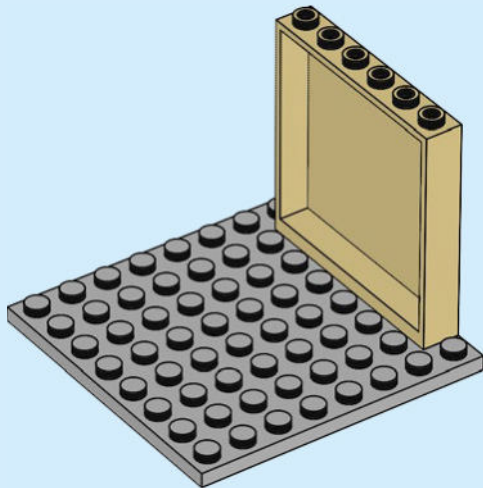



2x

3

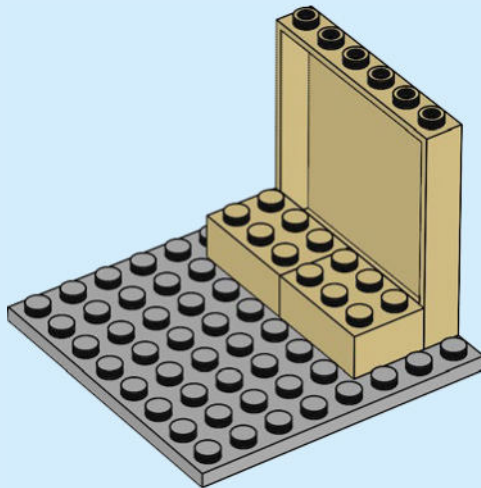

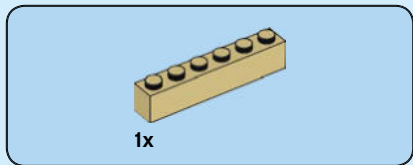

4

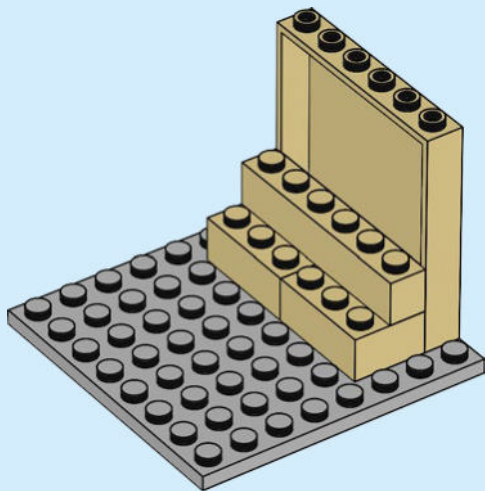



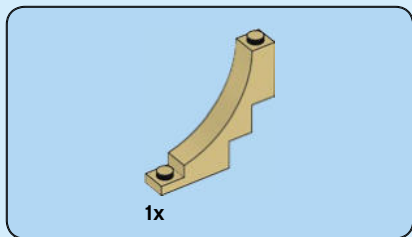

5

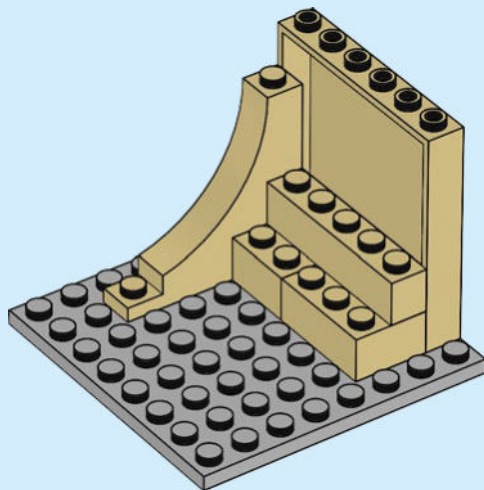

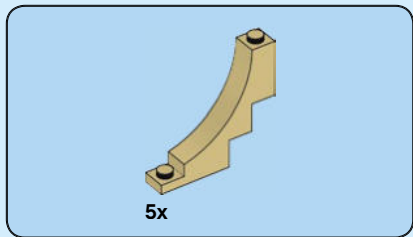

6

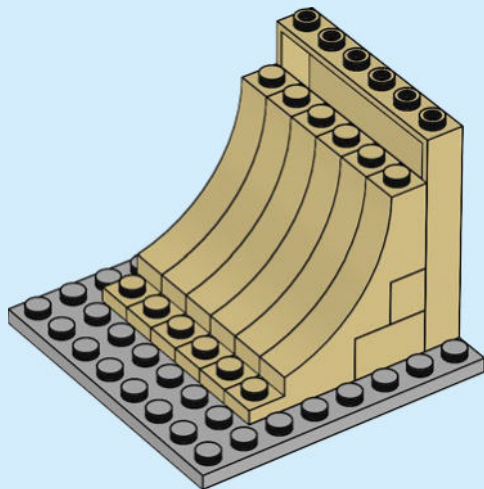

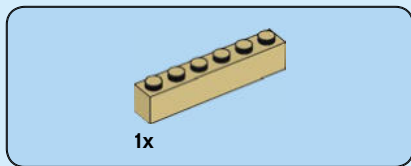

7

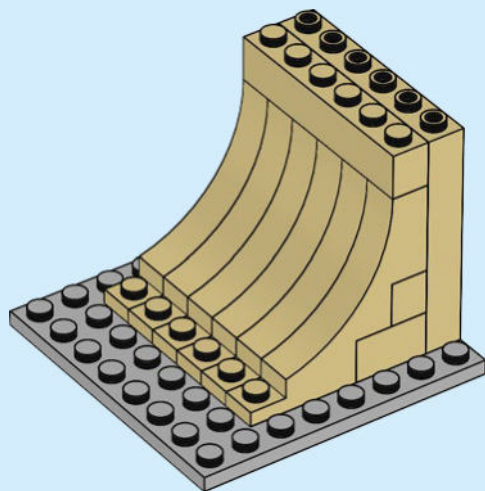

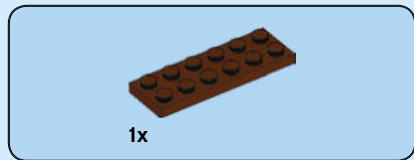

8

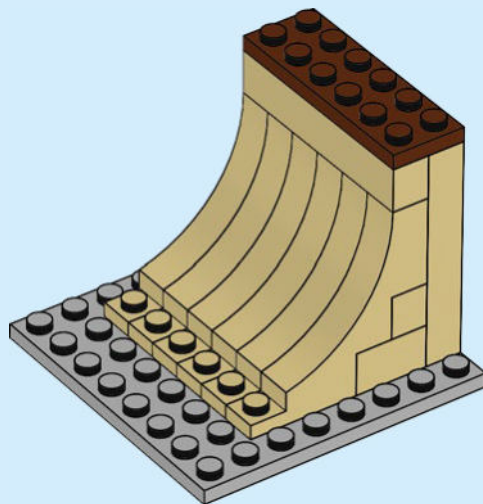

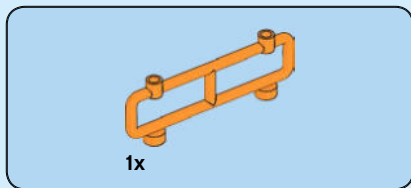

9

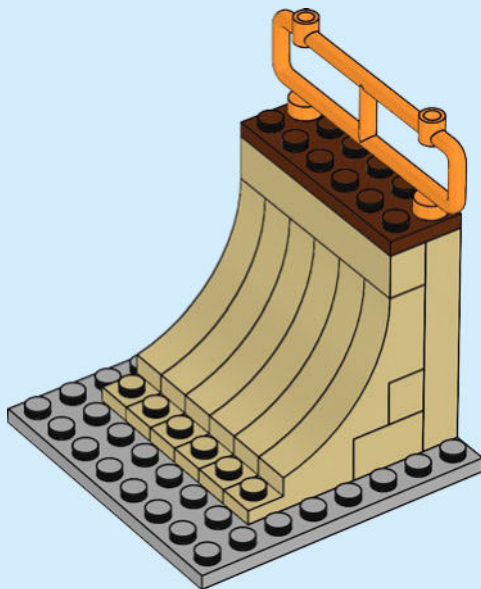



3x

10

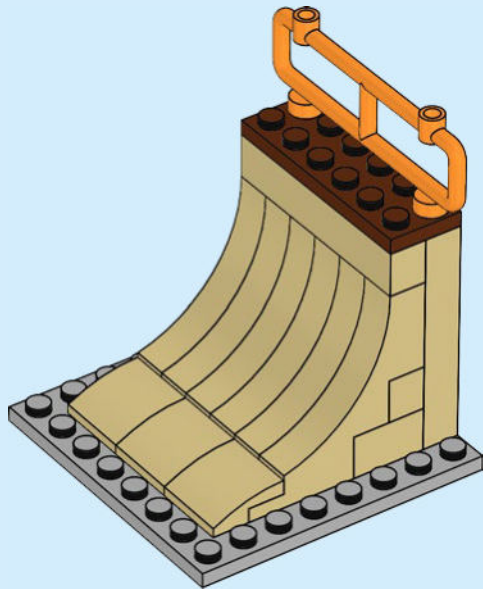

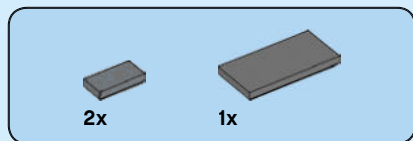

11

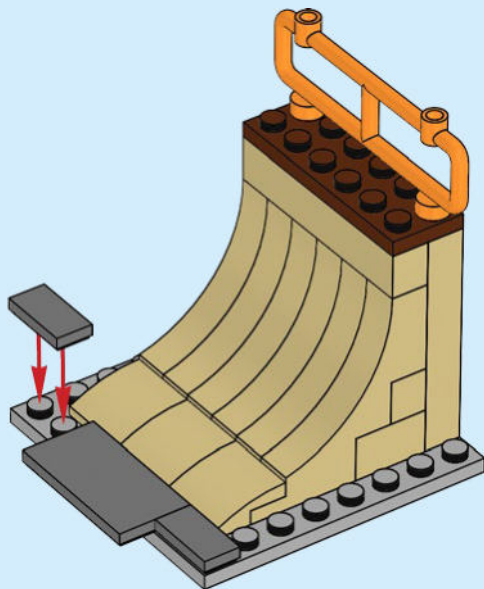



1x

1

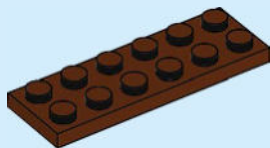



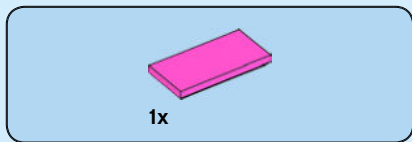

**2**

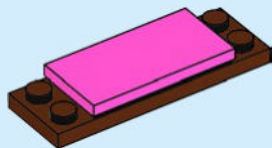

**3**

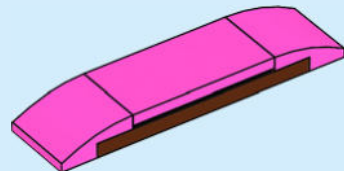

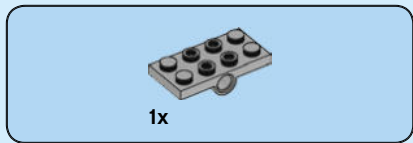

4

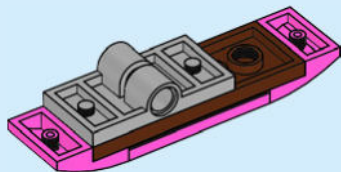



2x

5

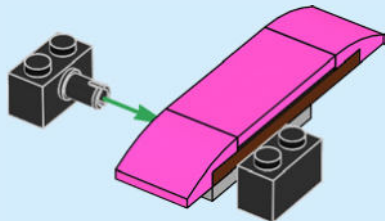

1x

6

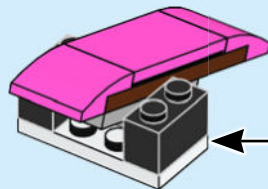
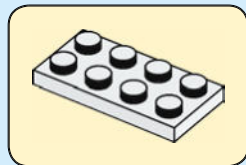

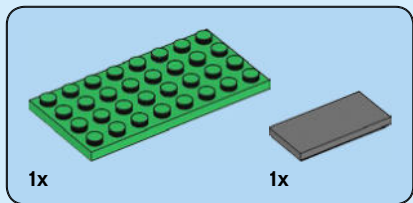

1

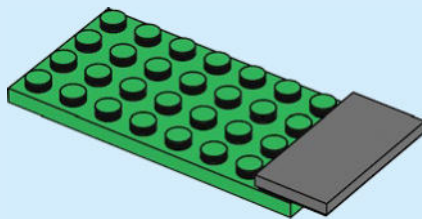

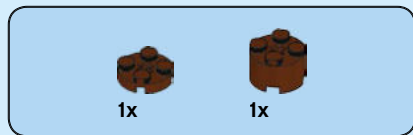

2

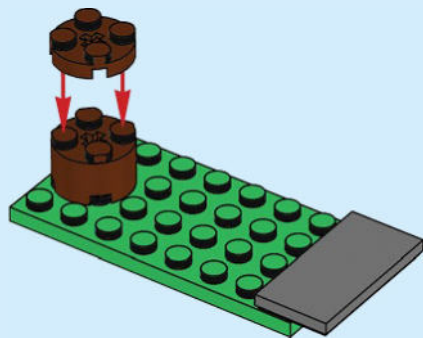

3

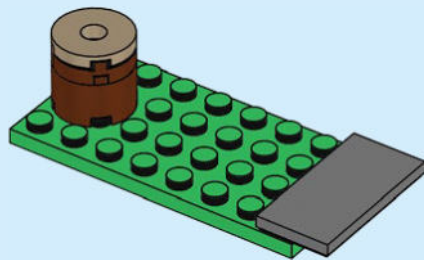



1x

4

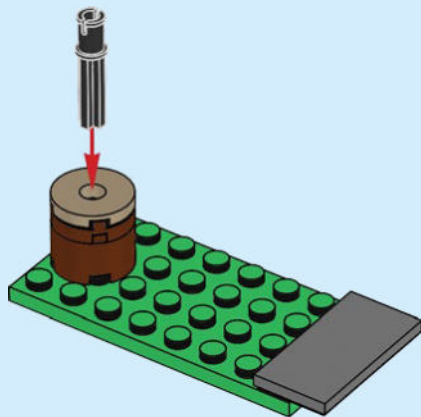

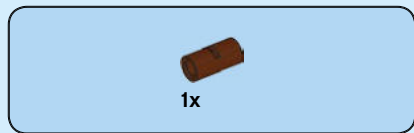

5

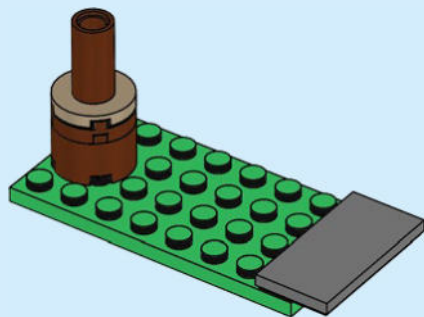

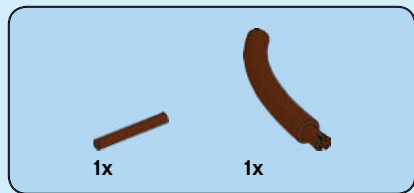

6

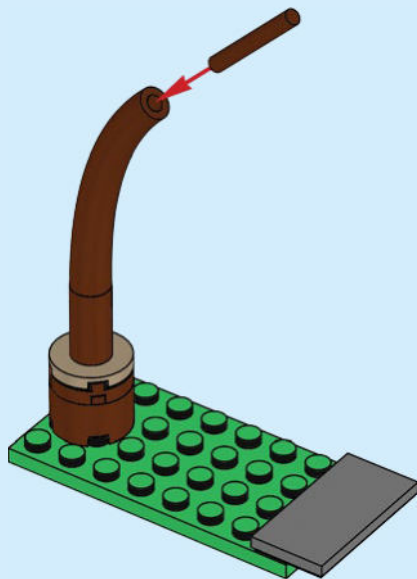





1x

7

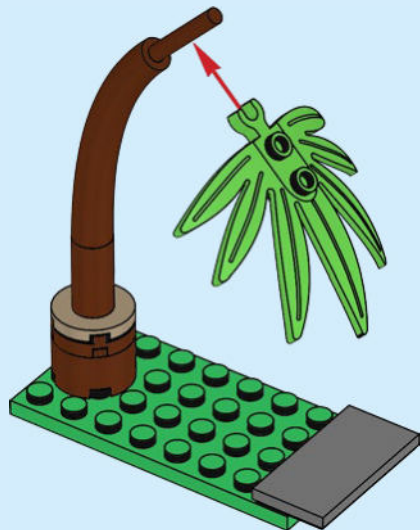



2x

8



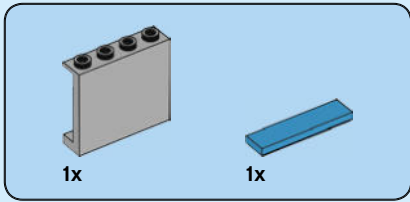

1

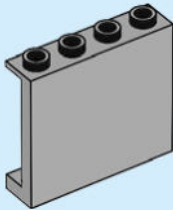

2

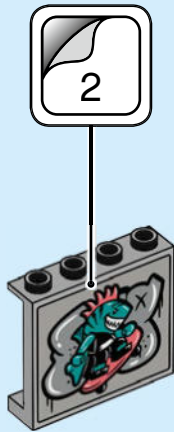

3

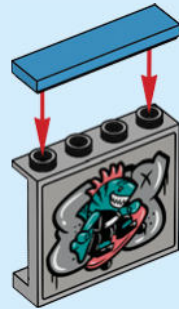

1

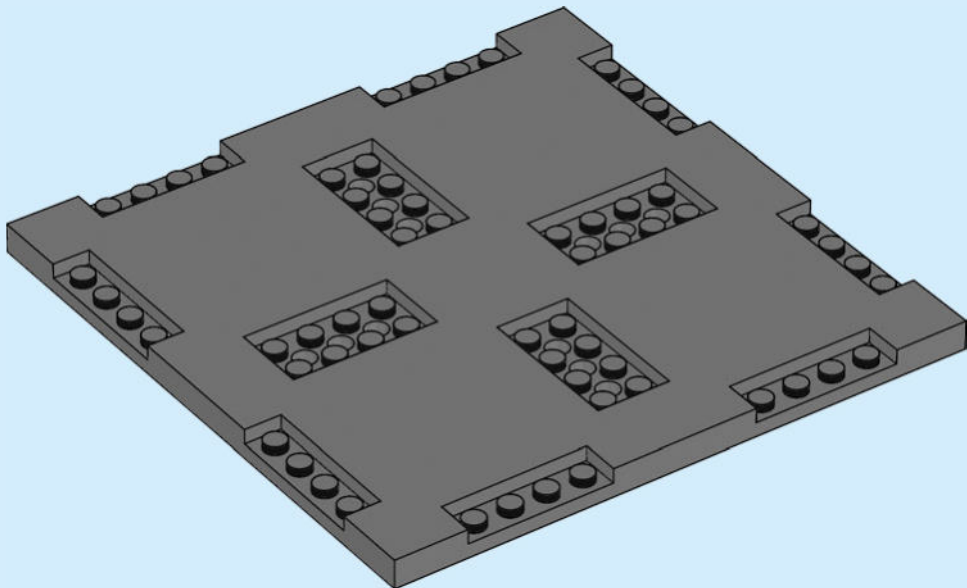

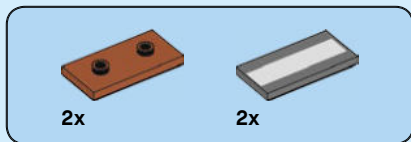

2

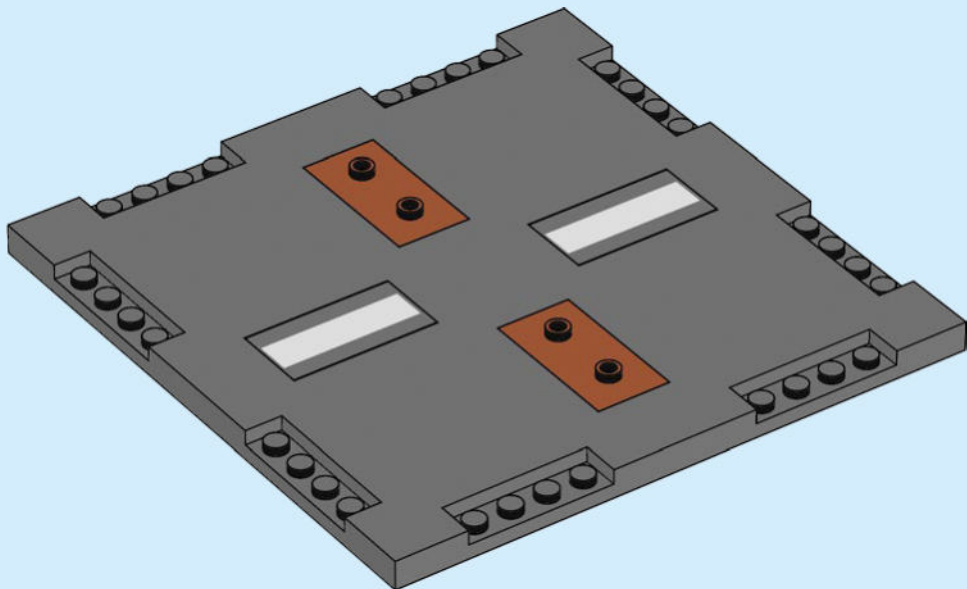

3



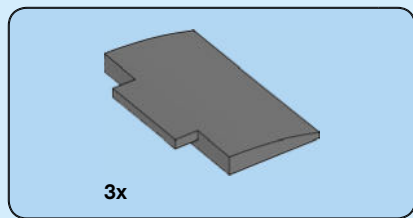

4

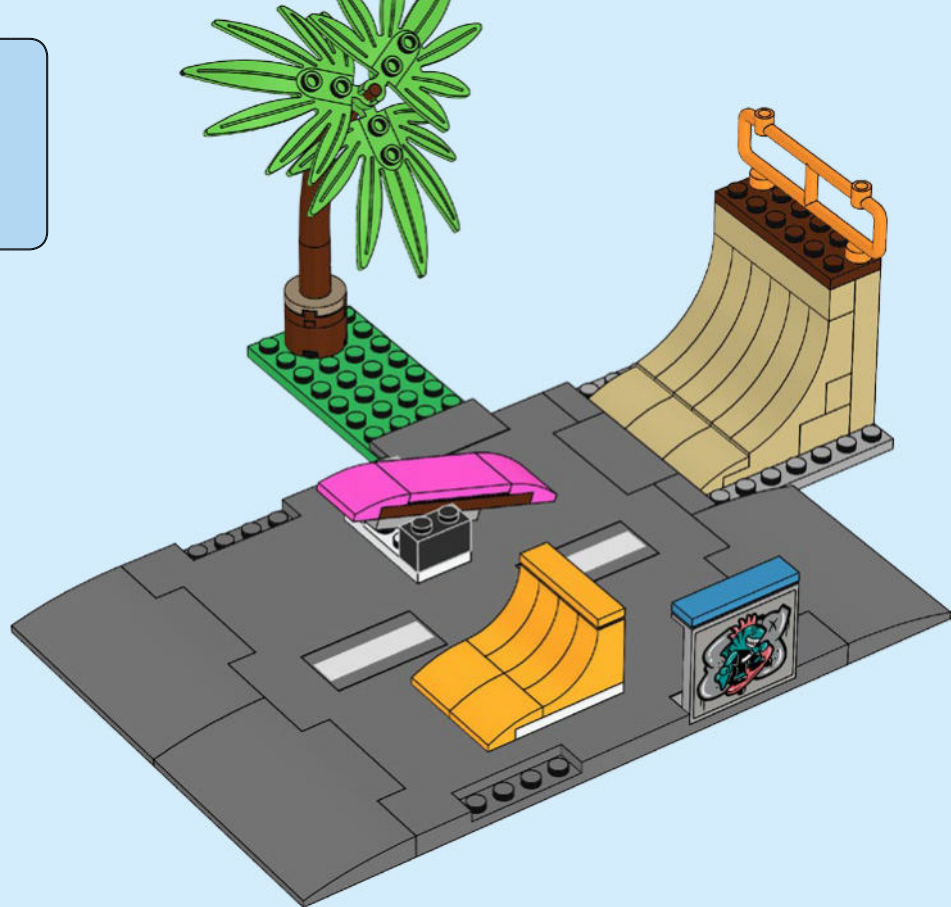

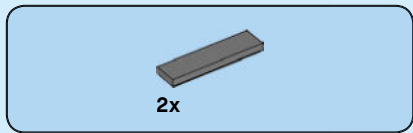

5

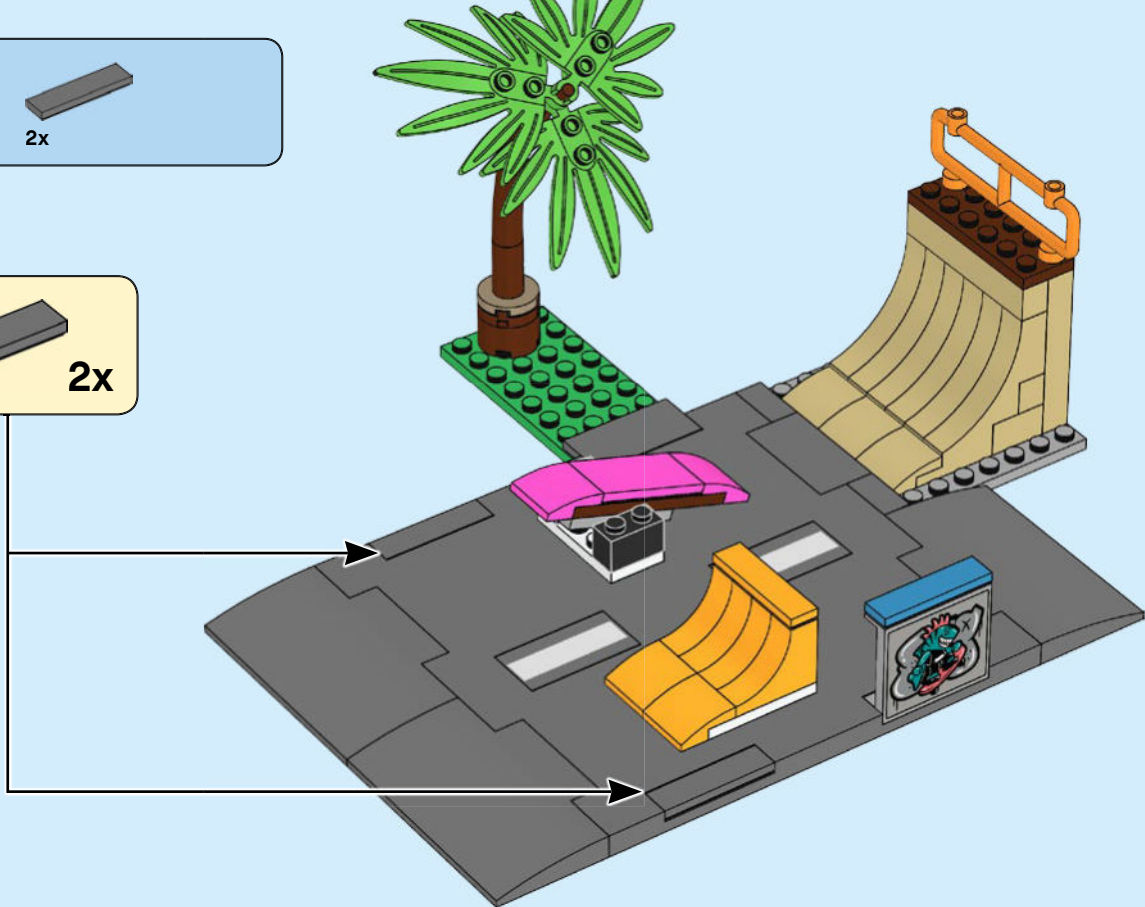
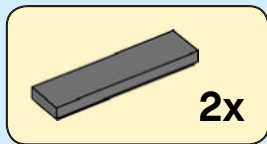



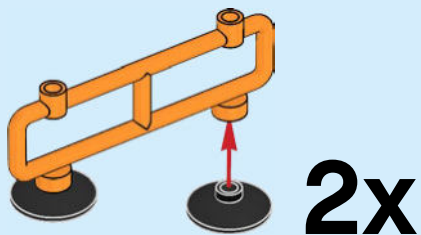
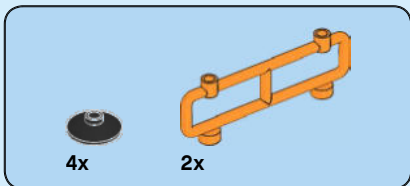
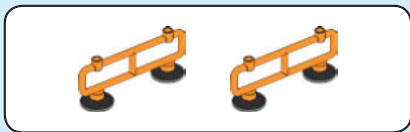

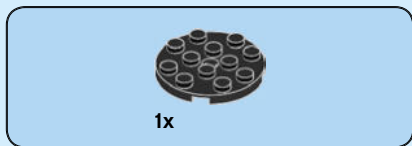
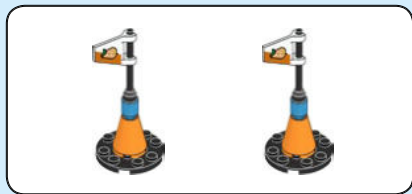

1

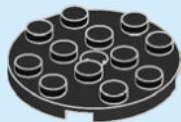

2





3

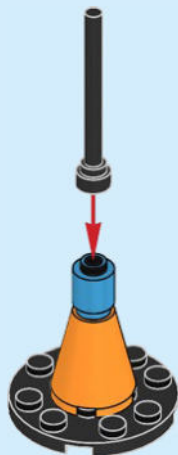

4

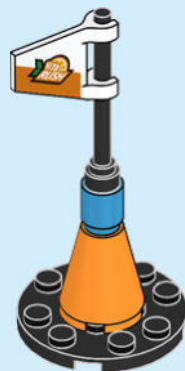

2x



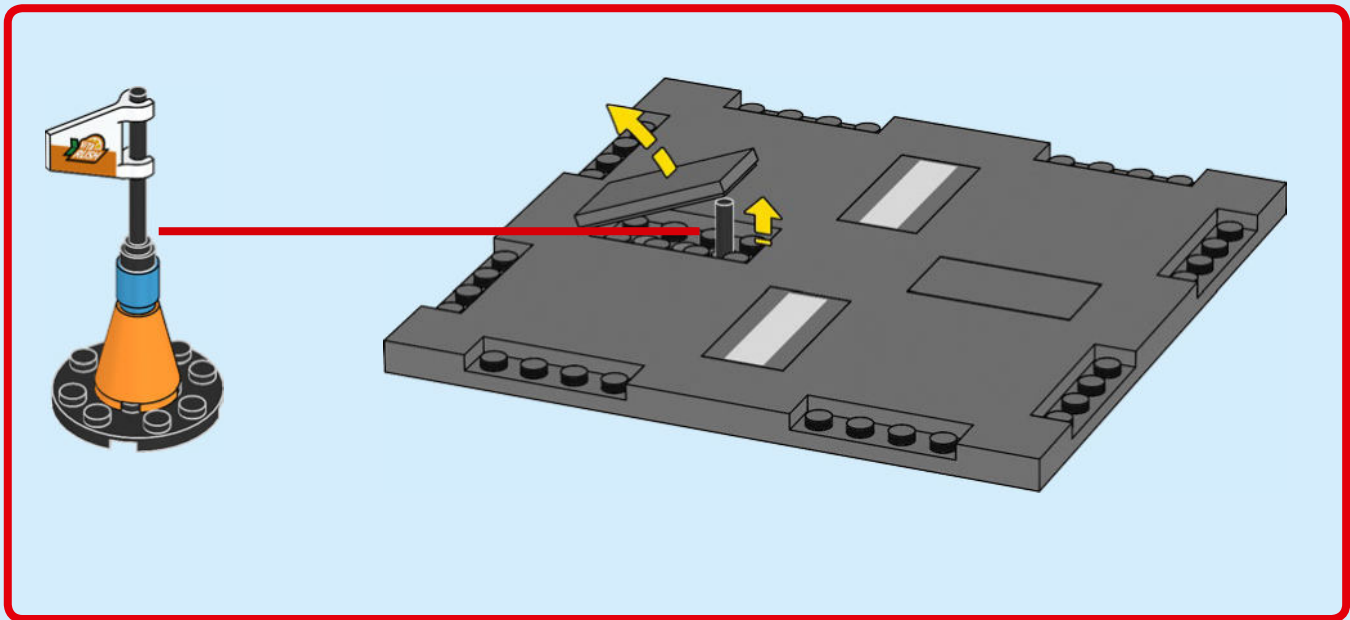







# CITY



60277



60275



60276

# CITY ADVENTURES

City Abenteuer  
Aventuras en City  
City Aventuras  
City kalandok  
City piedzivojumi  
乐高城市大冒险



60242



60243



60243 • 60276



60244



60244 • 60277



60245



60245



60246



60246



60276



60277



60242 • 60246 • 60276



60248 • 60280



60247 • 60281



60282



60282



60258



60258 • 60266



60292



60292



# CITY

## ADVENTURES

City Abenteuer  
Aventuras en City  
City Aventuras  
City kalandok  
City piedzīvojumi  
乐高城市大冒险

Aus der erfolgreichen TV-Serie!  
Vu dans la série télévisée à succès !  
Dalla divertentissima serie TV!  
¡De la popular serie de la tele!  
Da série de sucesso da TV!  
A népszerű TV-sorozatból!  
No populārā TV seriāla!  
源自热门动画片!



FROM THE HIT  
TV SERIES!

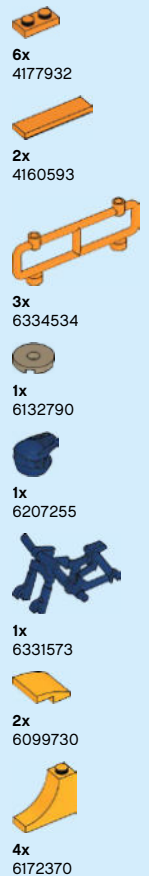
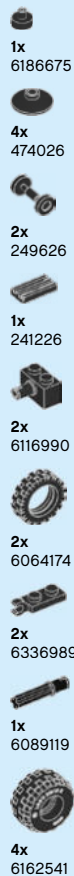
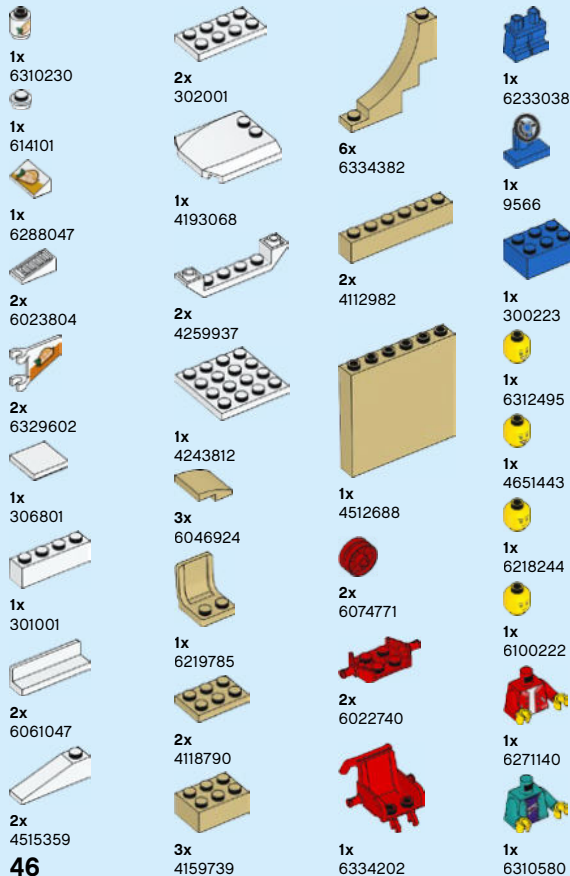



1x  
6072668



1x  
4211159



1x  
4211166



1x  
6173132



1x  
6075208



1x  
6326087

1x  
6325635



2x  
4211247

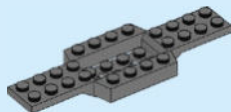

1x  
4259673

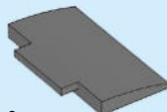

3x  
6325420



4x  
6178912

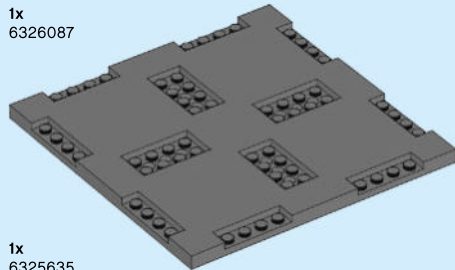

2x  
4211053



1x  
6121296



2x  
4560184



2x  
6329624



2x  
6066119



2x  
4211052



4x  
6214341



1x  
6290548



5x  
6133728



1x  
6205089



1x  
6231941



1x  
6005307



2x  
4653267



1x  
6251324



1x  
6327670



1x  
6174272



6x  
6322904



2x  
6186013



1x  
6146223



2x  
6266231



1x  
6171894



1x  
6059033



1x  
6176242

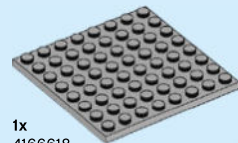

1x  
4166618



1x  
6056261



1x  
6289402



2x  
6222189



3x  
6347460



1x  
6329586



1x  
6043605



**Customer Service**

**Kundenservice**

**Service Consommateurs**

**Servicio Al Consumidor**

**LEGO.com/service or dial**



**: 00800 5346 5555**

**: 1-800-422-5346**

# WIN

GO TO [WWW.LEGO.COM/PRODUCTFEEDBACK](http://WWW.LEGO.COM/PRODUCTFEEDBACK) AND  
GIVE US YOUR SHORT **FEEDBACK** ABOUT THIS  
LEGO® SET FOR A CHANCE TO WIN  
A COOL LEGO PRIZE.

Terms & Conditions apply



## [LEGO.com/productfeedback](http://LEGO.com/productfeedback)

### GEWINNE

Erzähle uns auf  
[www.LEGO.com/productfeedback](http://www.LEGO.com/productfeedback)

etwas über die Erfahrungen, die du mit  
diesem LEGO® Set gemacht hast, und  
sichere dir die Chance auf einen coolen  
LEGO Preis!

Es gelten die Teilnahmebedingungen

### GAGNE

Rends-toi sur  
[www.LEGO.com/productfeedback](http://www.LEGO.com/productfeedback)

et donne-nous quelques commentaires sur  
ce produit LEGO® pour avoir une chance  
de gagner un prix LEGO !

Voir Conditions Générales

### GANAN

Visita  
[www.LEGO.com/productfeedback](http://www.LEGO.com/productfeedback)

y envíanos tu opinión acerca de este set  
LEGO®. ¡Participarás en el sorteo de un  
premio LEGO!

Términos y Condiciones aplicables

### 获取奖品

登录  
[www.LEGO.com/productfeedback](http://www.LEGO.com/productfeedback)

给出关于此乐高®套装的简短反馈，  
就有机会获得炫酷乐高奖品

《条款及条件》适用

LEGO and the LEGO logo are trademarks of the LEGO Group. ©2021 The LEGO Group.

6353749